

姜晓丹 等编著

中国纺织出版社

休闲配饰

小制作

服装技能速成培训丛书——休闲装系列④



服装技能速成 培训丛书

——休闲装系列

- ① 休闲女装设计与制板
- ② 休闲女装款式裁剪图册
- ③ 休闲女装缝制要点与技巧
- ④ 休闲配饰小制作



ISBN 7-5064-1764-2

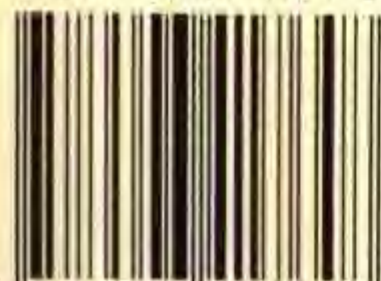

9 787506 417648 >

定价：18.00 元

休闲

服装色彩搭配与配饰——休闲系列④



休闲

配饰小制作

姜晓丹 木子 林丽 陈阿美 编著
林惠娟 陈培源 木木 方田樱



中国纺织出版社

内 容 提 要

本书是“服装技能速成培训丛书”——休闲装系列中的第四分册。书中主要介绍休闲布帽、布包袋、实用居室挂袋和一些日用小饰物的制作步骤、方法，利用这些简单易学的方法和做服装剩余的碎布头，便可制作出与休闲装相搭配的服饰配件及各种实用小饰物，既美化我们自身、又装点居室环境，使您的家更温馨，生活更富有情趣。

图书在版编目(CIP)数据

休闲配饰小制作/姜晓丹等编著. —北京:中国纺织出版社, 2000. 1

(服装技能速成培训丛书:休闲装系列:④)

ISBN 7-5064-1764-2/TS·1385

I. 休… II. 姜… III. 服饰-生产工艺 IV. TS941.7

中国版本图书馆CIP数据核字(1999)第72457号

责任编辑:姜娜琳 责任校对:俞坚沁
责任设计:胡雪萍 责任印制:初全贵

中国纺织出版社出版发行

地址:北京东直门南大街6号

邮政编码:100027 电话:010-64168226

中国纺织出版社印刷厂印刷 各地新华书店经销

2000年1月第一版第一次印刷

开本:787×1092 1/16 印张:8.25 插页:4

字数:197千字 印数:1—5000 定价:18.00元

凡购本书,如有缺页、倒页、脱页,由本社发行部调换









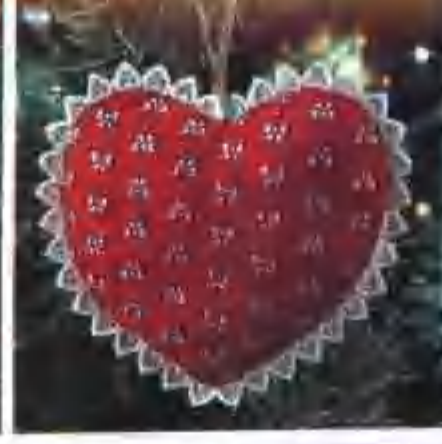





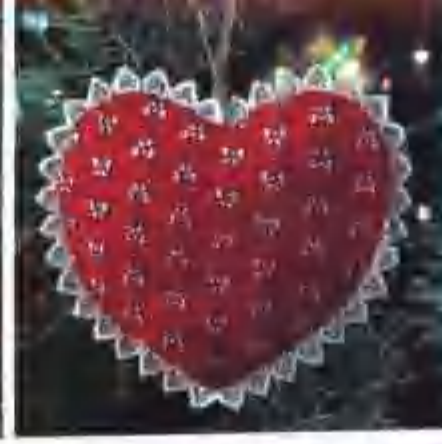

“服装技能速成培训丛书——休闲装系列”是为服装的初学者、自学者能快捷掌握休闲女装的设计、制板、缝制工艺，以及配饰制作等技能而编写的。本系列共有四个分册：《休闲女装设计与制板》、《休闲女装款式裁剪图册》、《休闲女装缝制要点与技巧》和《休闲配饰小制作》。全书以直观图示与详细文述相结合展开休闲女装设计——制板——各种款式裁剪——缝制——休闲配饰制作的速成内容，是一套较为完整的休闲女装设计、制作技能丛书。

休闲装是当前的流行服装，以其独具的穿着效果展示出现代人的生活观念、精神面貌、审美情趣及体态活动。它不仅仅在款式造型上进行简单的宽松设计，而是要在规格、板型、结构、制作工艺及配饰方式、面料质地、色彩等方面都体现出舒适、实用、美观大方的时代感，既顺应服装流行趋势的潮流，又适应人们现代生活的需要。

《休闲女装设计与制板》主要由两部分内容组成，第一部分是休闲女装款式设计的基础及快速进行系列设计的技巧，其中有休闲装的构成要素、造型特点，结构比例的新概念，面料、色彩的流行特征，以及如何设计塑造出超越体型而富有律动感的新造型等内容。为能较快地绘出款式效果图，书中以人体的基本结构和形体的某一动态为基础进行系列设

计，既能体现出款式的穿着效果，又无需苦思设计绘制复杂的多姿人体动态。第二部分是休闲装的样板设计，以图解的形式说明制板的基础知识和方法步骤，以及如何利用休闲装基础样板进行款式系列变化的技巧。

《休闲女装款式裁剪图册》为广大读者绘制了 118 款四季流行的休闲装款式，每款配有服装效果图和裁剪图，同时还提供精美、时尚的休闲装彩色图片，以供读者参考、模拟。

《休闲女装缝制要点与技巧》主要以休闲装部位分解示意图介绍简便易学的缝制方法、步骤与技巧，便于读者较快掌握。

《休闲配饰小制作》是以图解的形式介绍休闲布帽、布包袋、实用居室挂袋和日用小饰物等的制作步骤与方法。利用家里的零头布或做休闲装裁剩的碎布，可以制作各式各样的与服装相搭配的服饰配件或家庭日用品，既美化我们自身、装点居室环境，又经济、实用，使生活更富有情趣。

编者
1999 年 11 月

| | |
|---------------|------|
| 休闲布帽的制作..... | (1) |
| ●圆顶女士帽..... | (2) |
| ●圆顶装饰帽..... | (5) |
| ●休闲睡帽..... | (8) |
| ●少女六片帽..... | (9) |
| ●淑女遮阳蝶结帽..... | (12) |
| ●八片软檐帽..... | (15) |
| ●金秋休闲贝蕾帽..... | (17) |
| ●潇洒棒球帽..... | (20) |
| ●装饰珠花骑士帽..... | (23) |
| ●典雅女士帽..... | (26) |
| ●八棱圆形帽..... | (28) |
| ●圆顶六片连檐帽..... | (30) |
| ●休闲旅游遮阳帽..... | (32) |

| | |
|--------------|------|
| 布包袋的制作..... | (35) |
| ●女士挎肩袋..... | (36) |
| ●旅行行李袋..... | (38) |
| ●少女双肩背袋..... | (41) |

| | |
|------------------|------|
| ●休闲购物提袋····· | (44) |
| ●折叠方便袋····· | (46) |
| ●抽口双肩背袋····· | (48) |
| ●淑女挎肩袋····· | (52) |
| ●郊游双肩背袋····· | (55) |
| ●子母挂包····· | (65) |
| ●双肩背子母袋····· | (69) |
| ●抽口少女双肩背袋····· | (73) |
| ●旅游抽口双肩背圆筒袋····· | (76) |
| ●蝶结装饰购物提包····· | (79) |
| ●休闲购物套包····· | (81) |
| ●折口双肩背袋····· | (84) |
| ●圆筒抽口手袋····· | (86) |
| ●珠穗抽口手袋····· | (90) |

多用装饰挂袋的制作·····(92)

| | |
|--------------|-------|
| ●补花双兜挂袋····· | (93) |
| ●多用鱼纹挂袋····· | (97) |
| ●房形装饰挂袋····· | (99) |
| ●一帆风顺挂袋····· | (103) |
| ●彩格四兜挂袋····· | (105) |
| ●多用图案挂袋····· | (107) |
| ●联组多用挂袋····· | (109) |

实用工艺物品的制作·····(113)

| | |
|----------------|-------|
| ●鱼形抱枕····· | (114) |
| ●卫生纸装饰套····· | (117) |
| ●帽形卫生纸装饰套····· | (121) |
| ●餐巾纸装饰套····· | (125) |

休闲布帽的制作

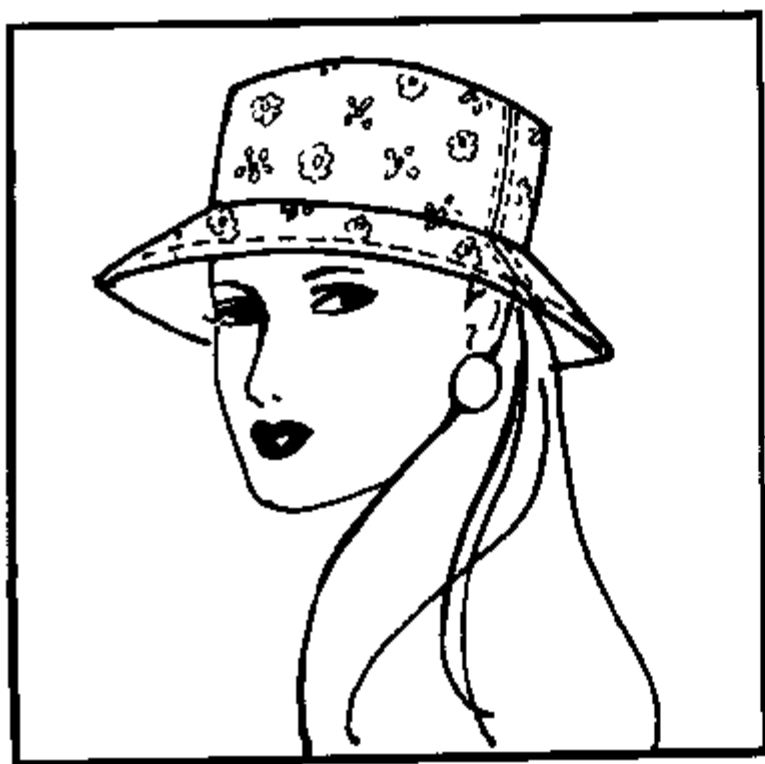



● 圆顶女士帽

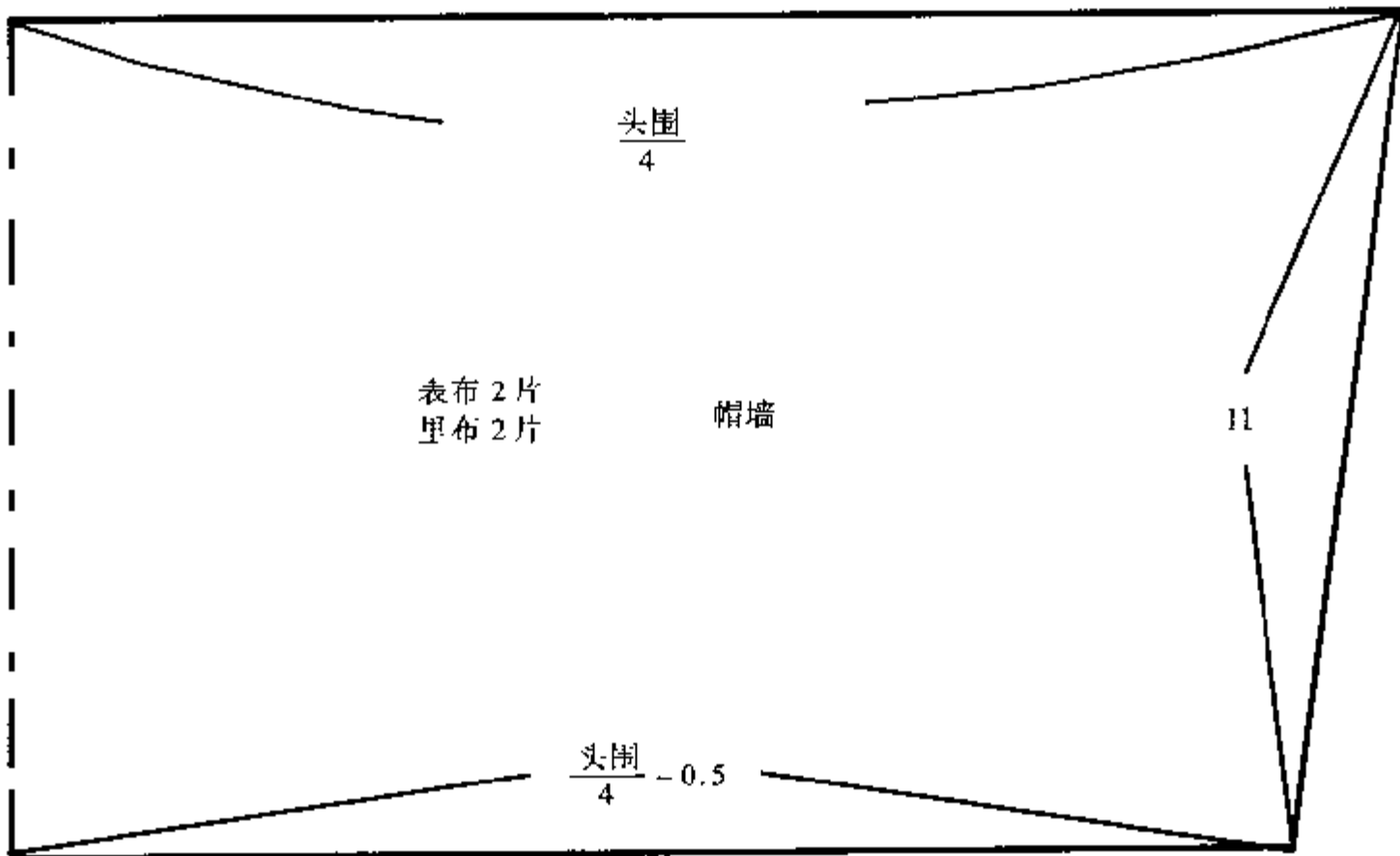
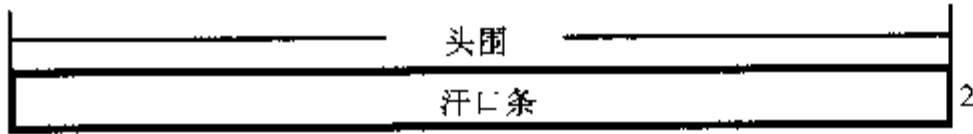
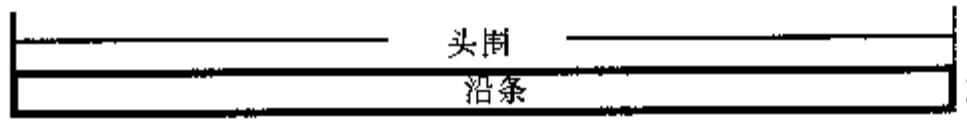
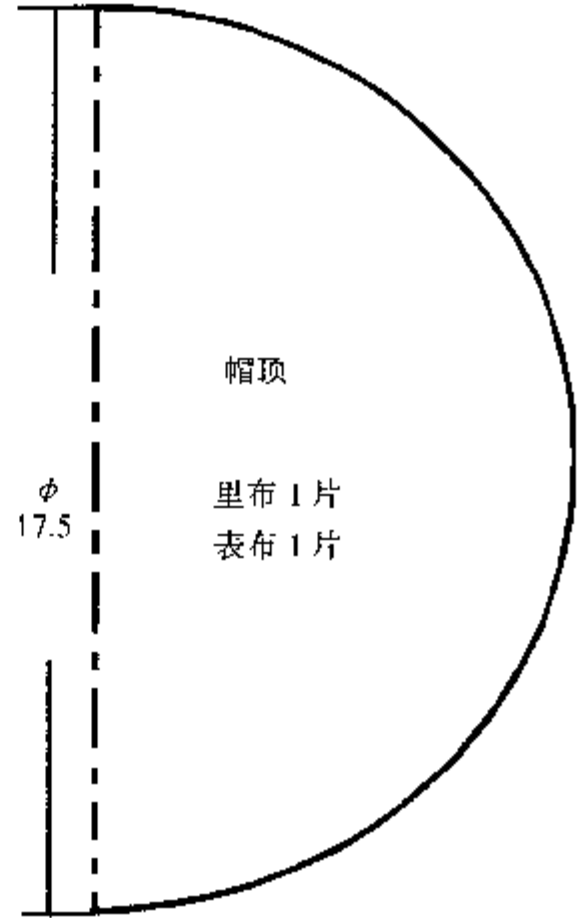

①缝合帽墙的表、里布和衬

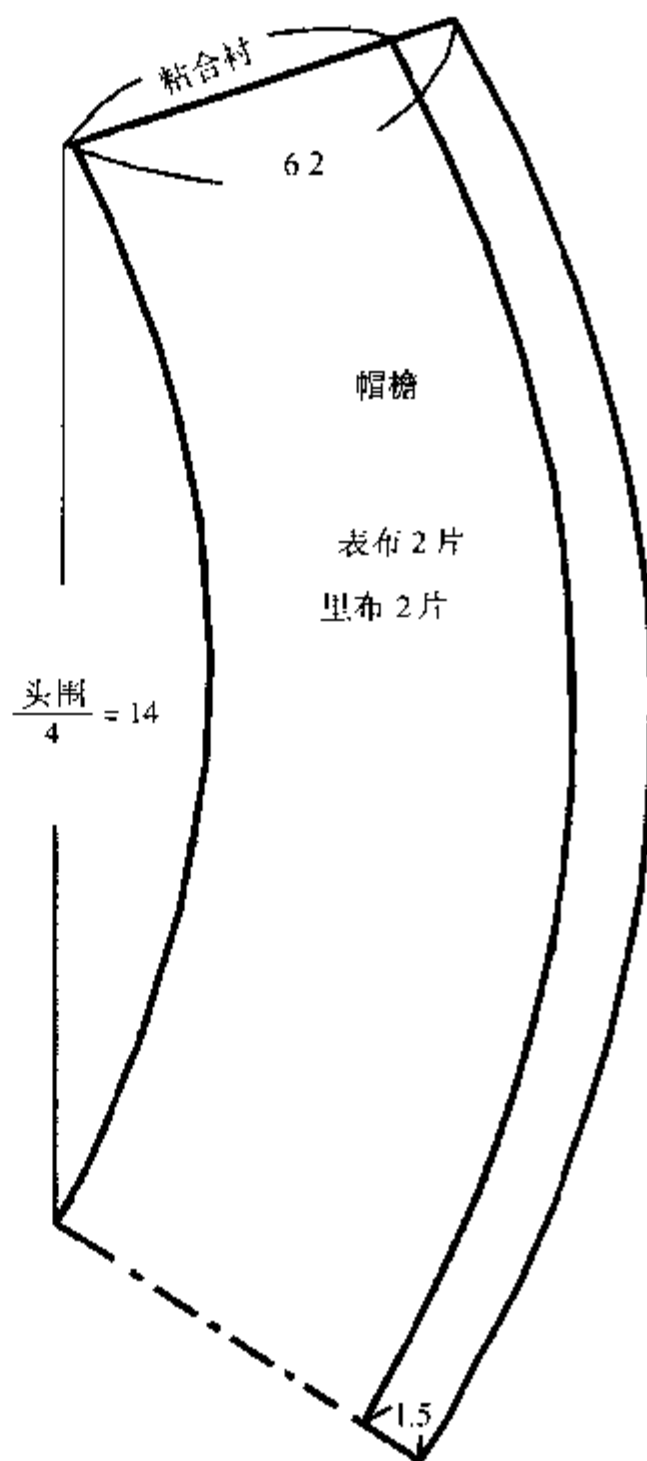
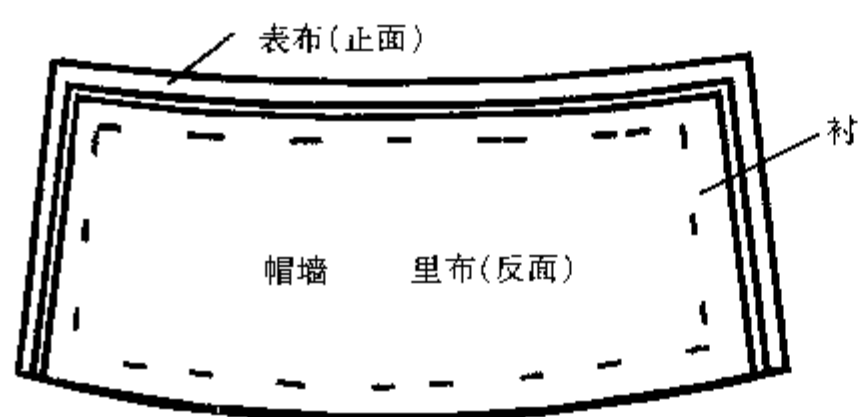

②劈缝后缉双明线

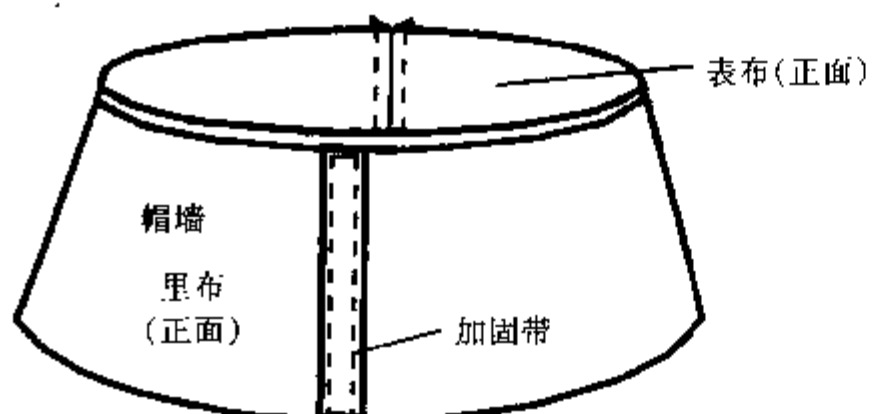

③扣好帽顶后用沿条压住缝份

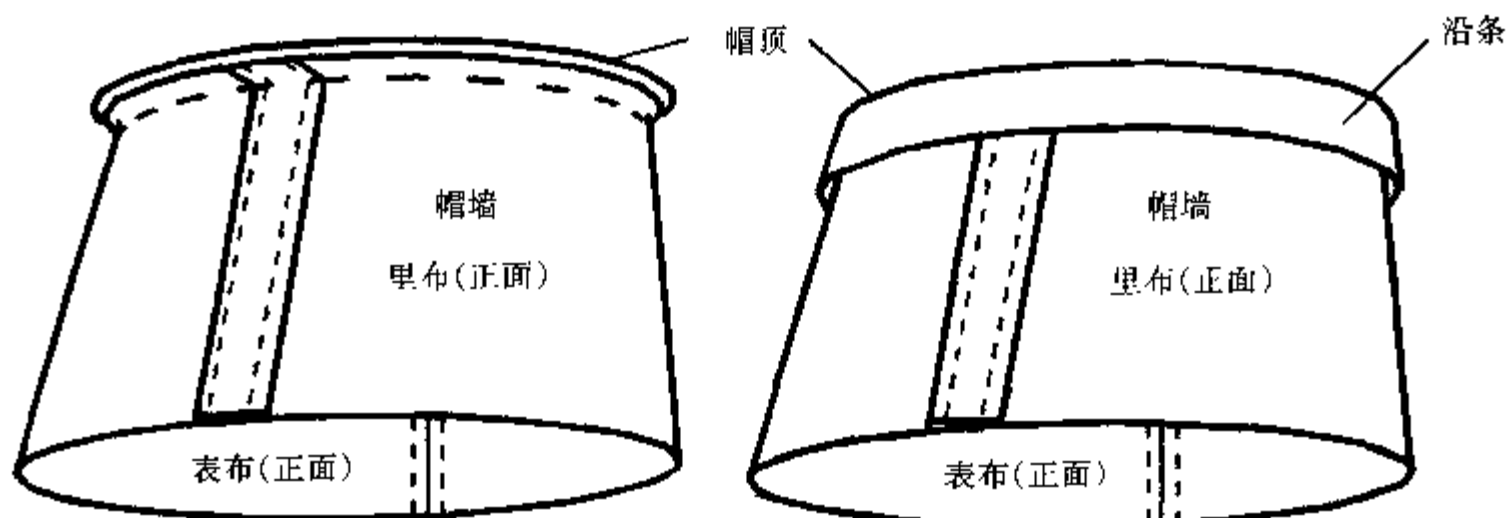

④缝合帽檐

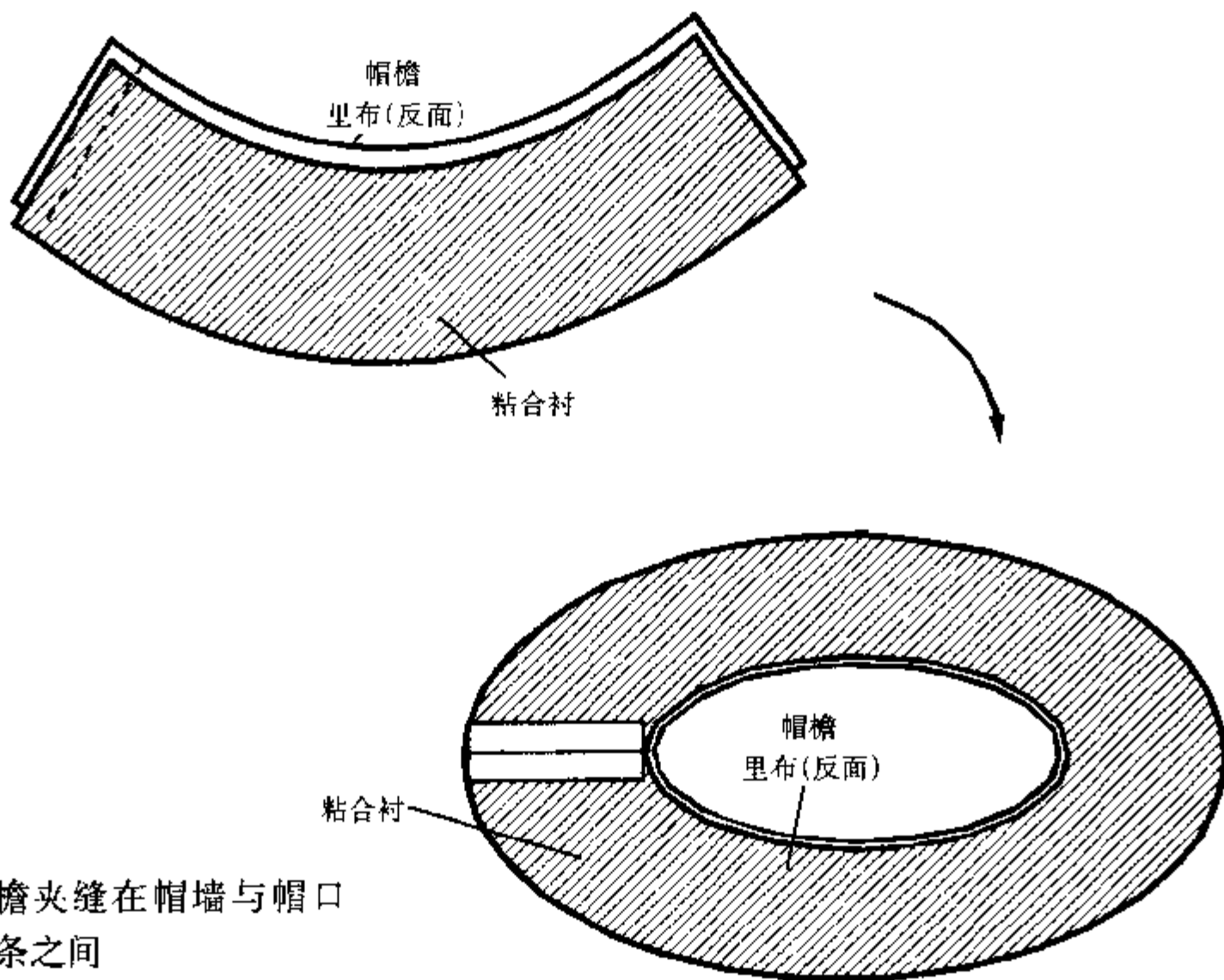

⑤将帽檐夹缝在帽墙与帽口汗口条之间

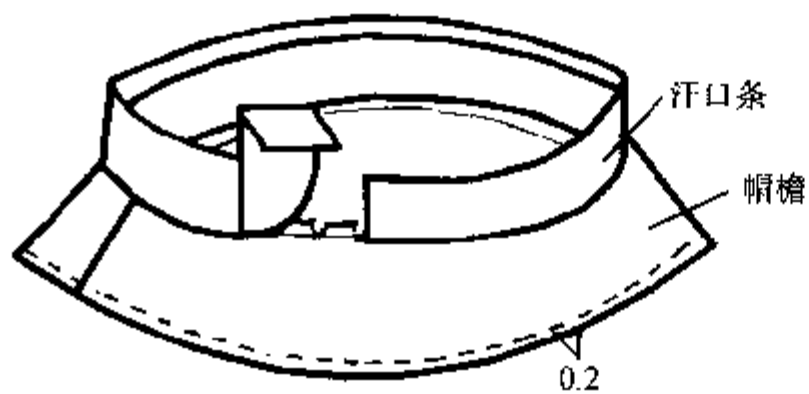

⑥帽檐边缉明线

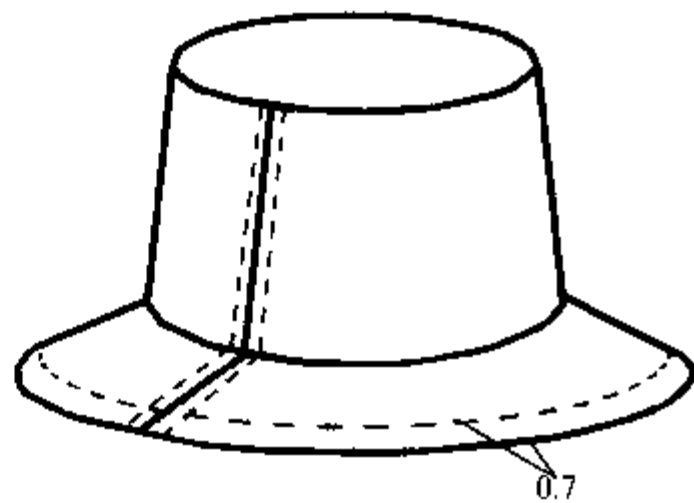
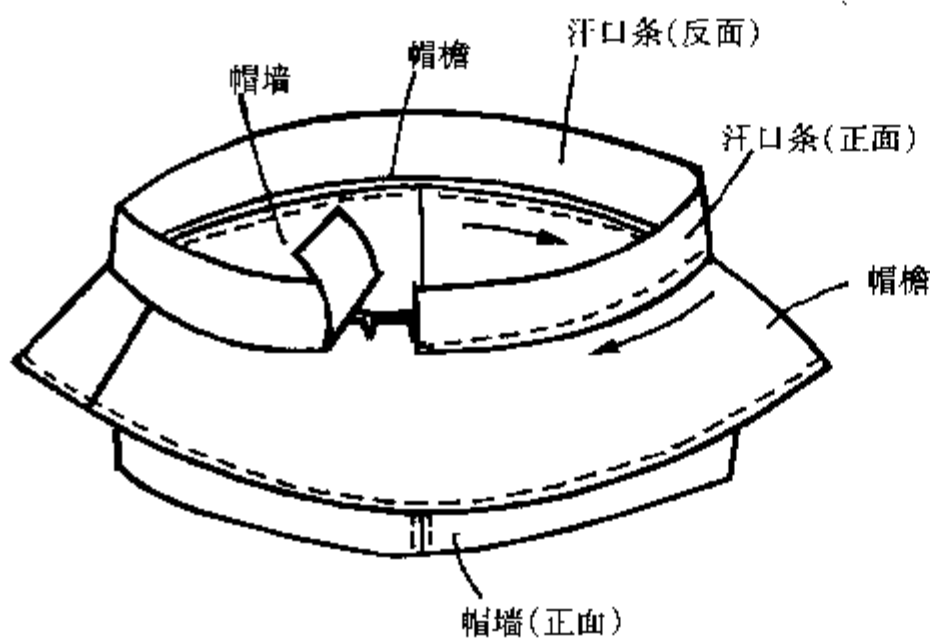



● 圆顶装饰帽

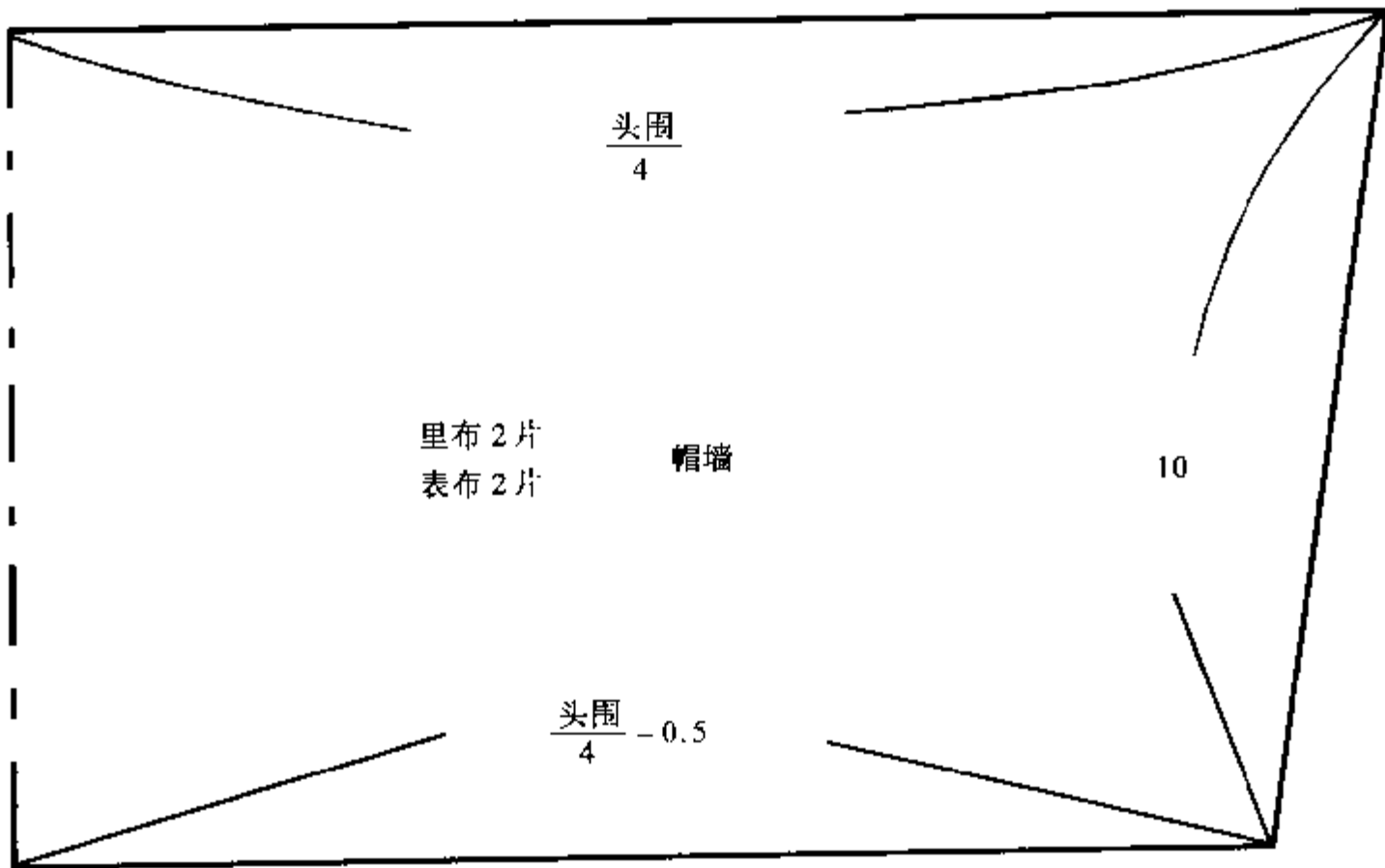
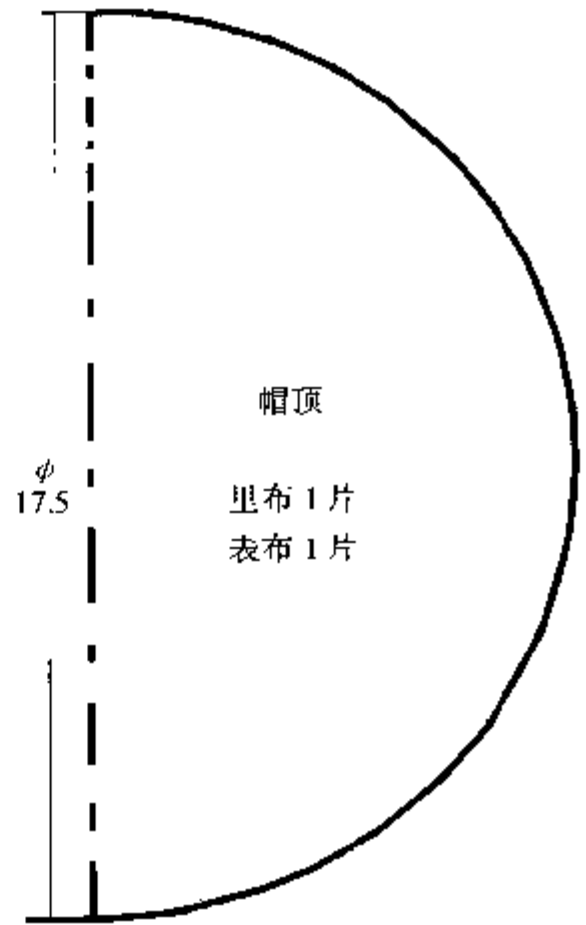

①缝合帽墙的表、里布和衬

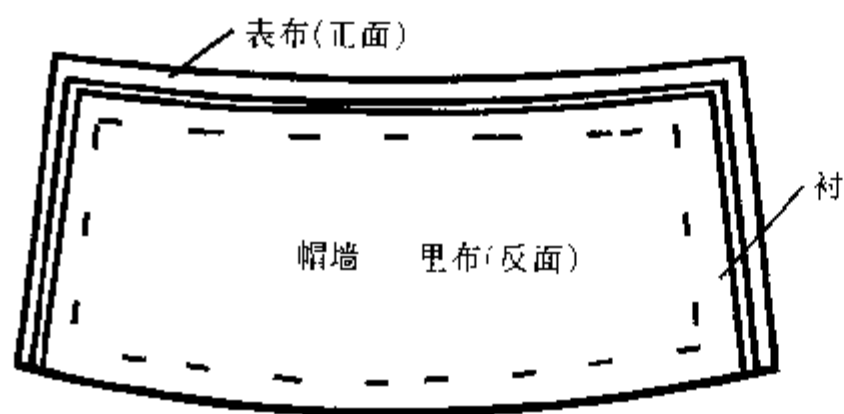

②劈缝后缉双明线

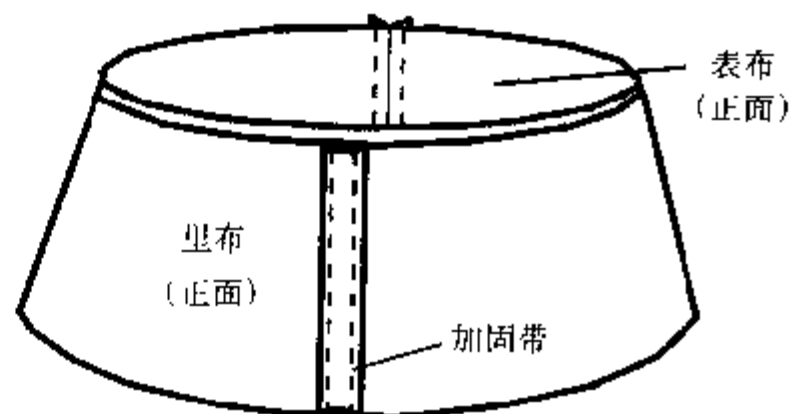

③扣好沿条压住缝份

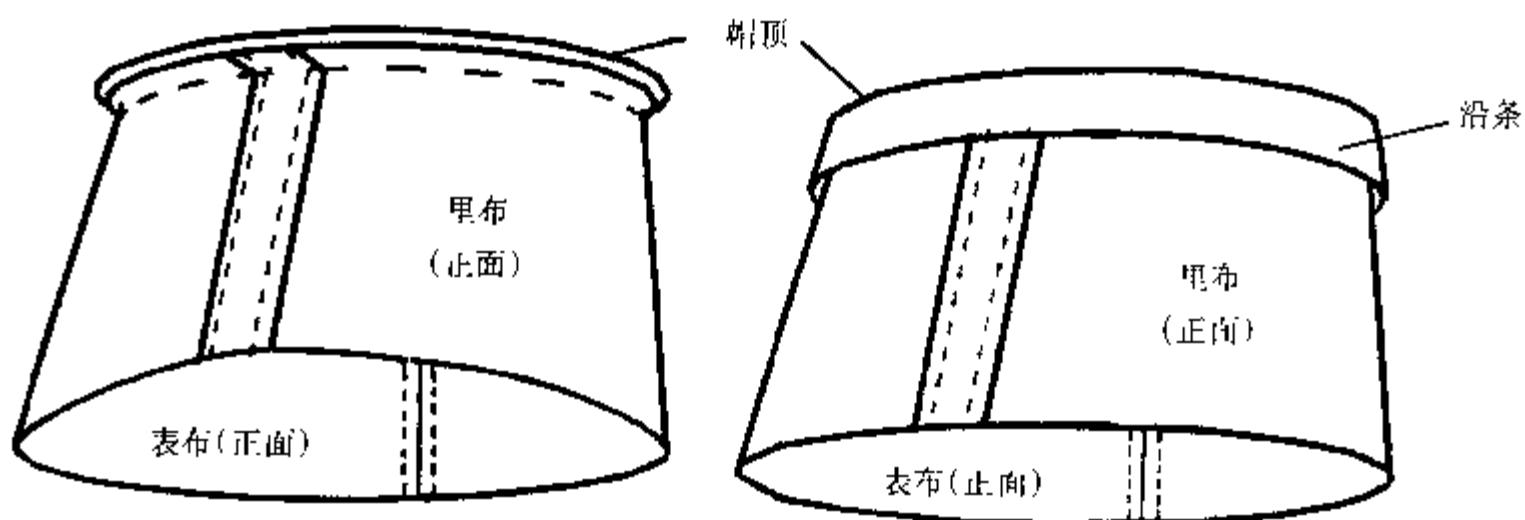

④缝合帽檐

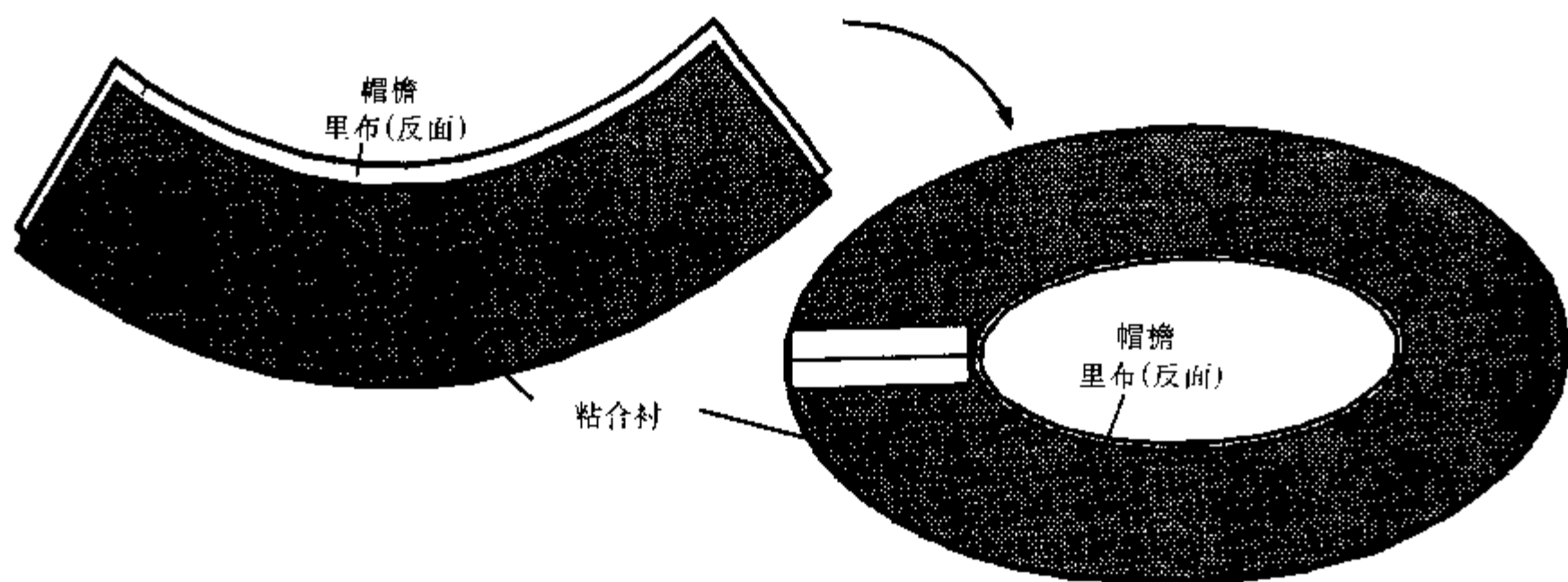

⑤ 缝帽檐时需加帽口汗口条

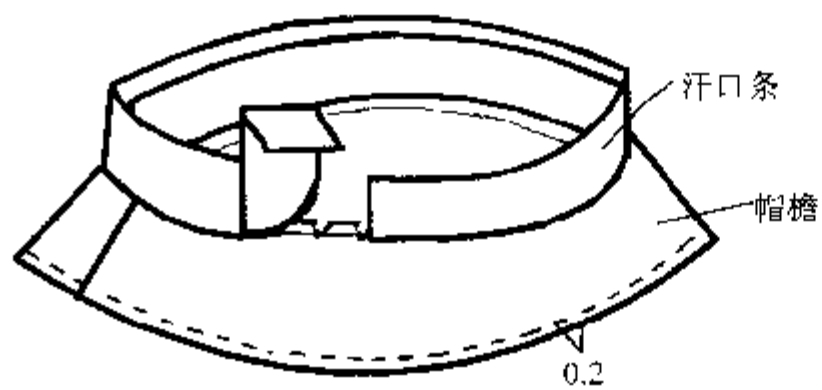

⑥ 帽檐边缉明线

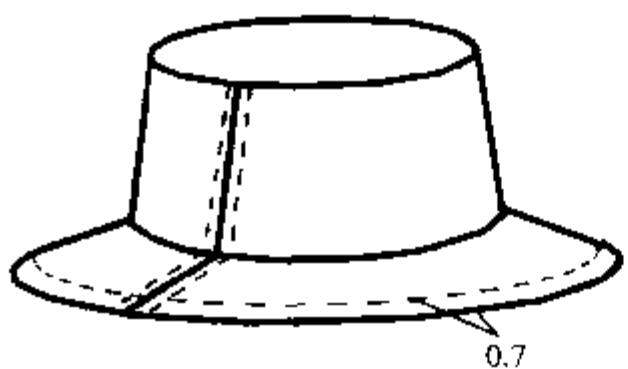

⑦ 制作帽子小装饰

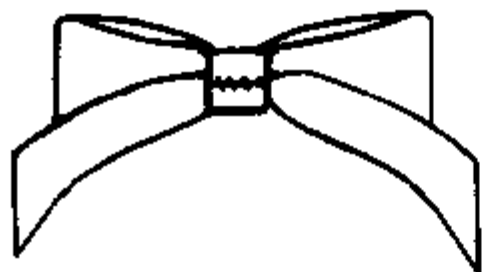
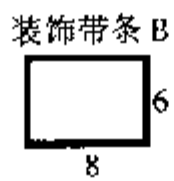
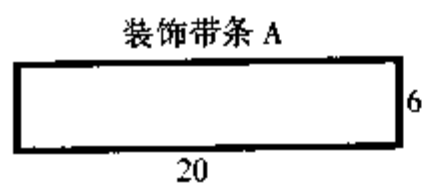
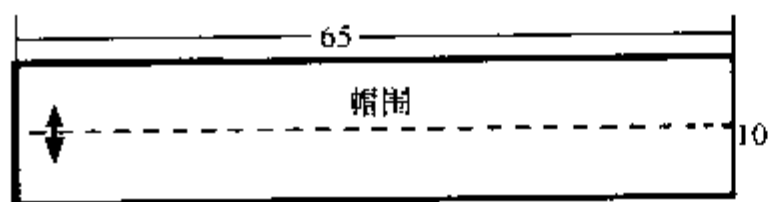

⑧ 装饰结缝于帽围上

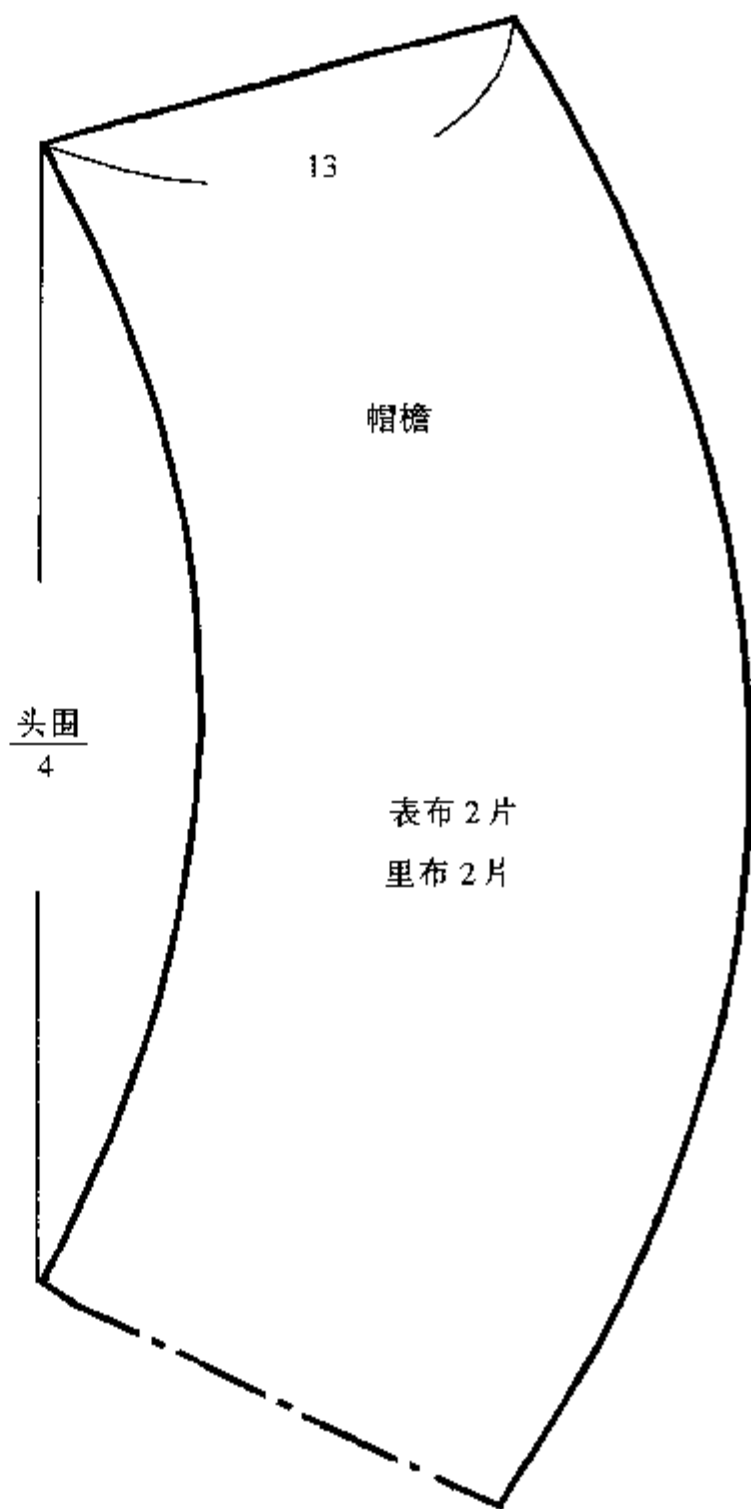
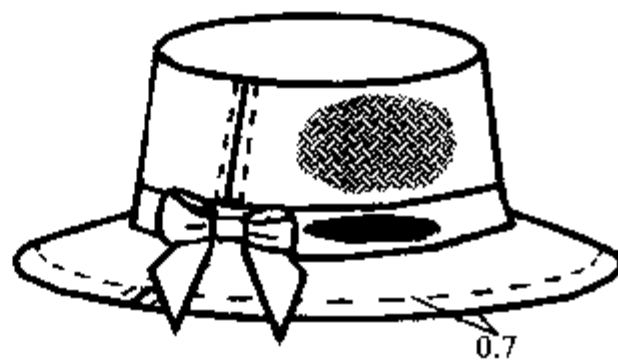



● 休闲睡帽

① 缝合表布侧缝

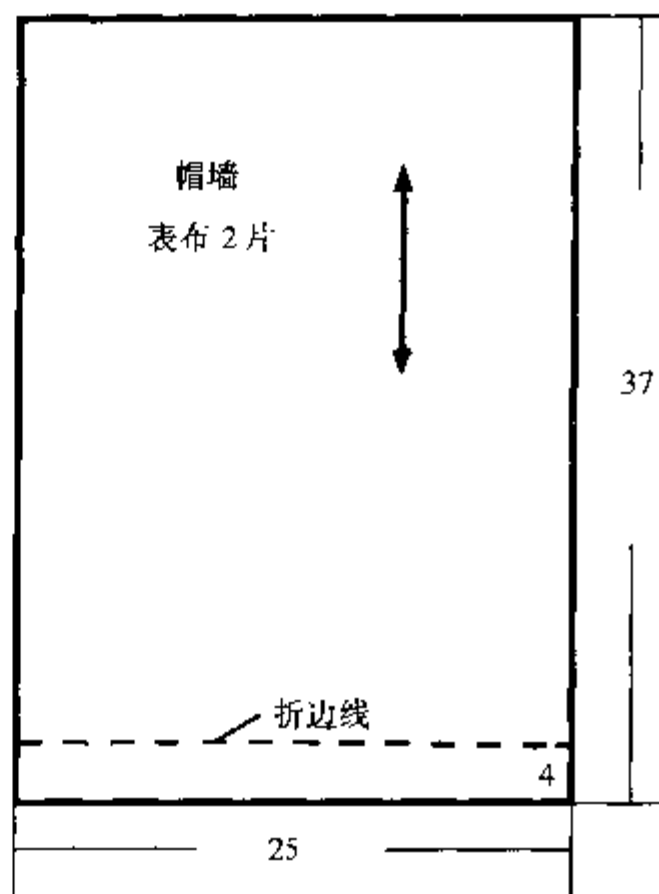

② 劈缝并熨烫

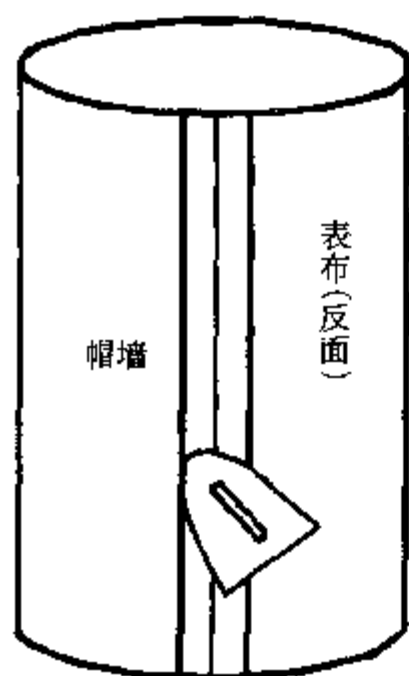

③ 折好帽边缉明线

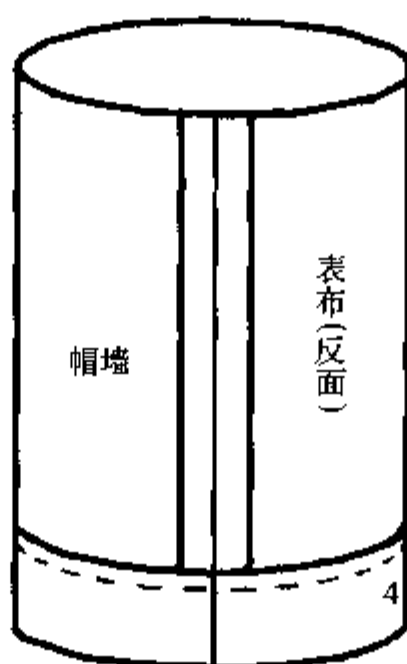

④ 系带



● 少女六片帽

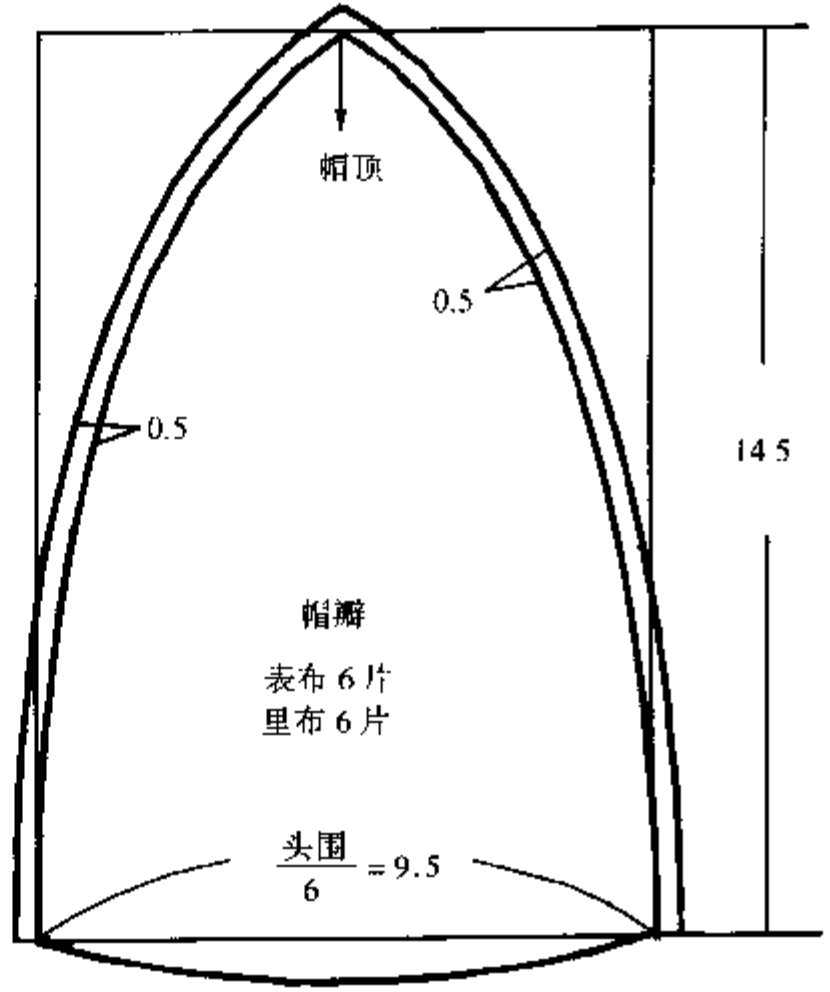

① 缝合帽瓣并劈缝熨烫

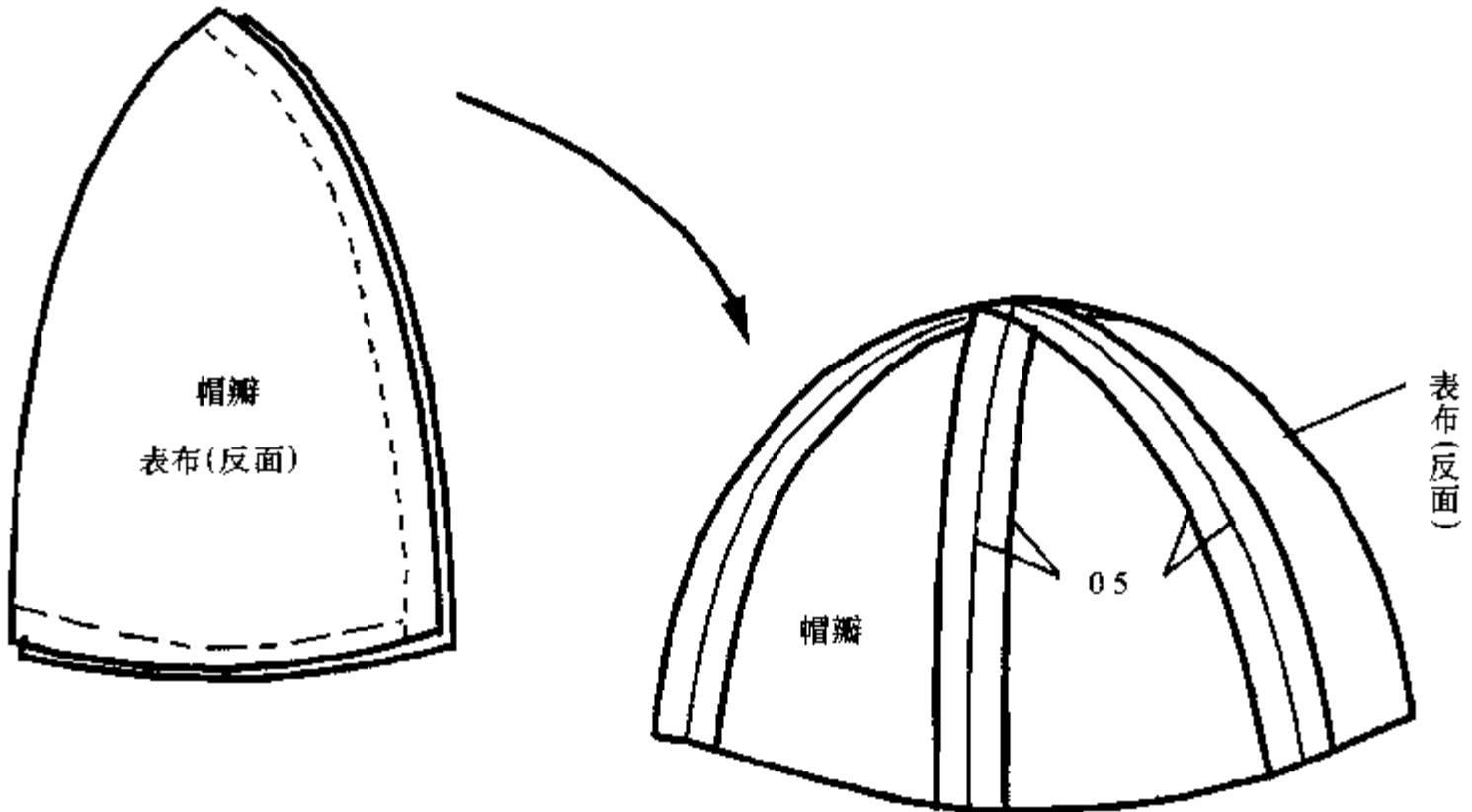

②缝合里布并劈缝熨烫

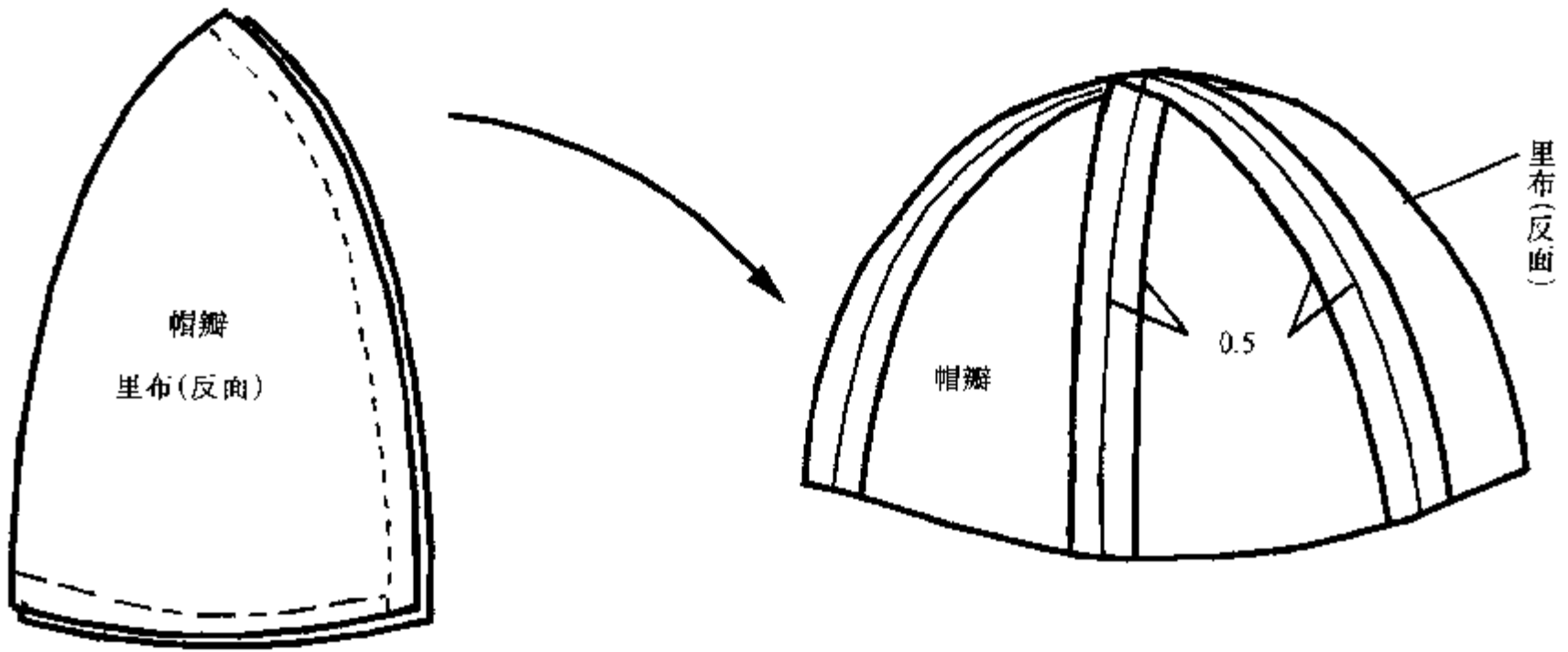

③帽子表布缉明线

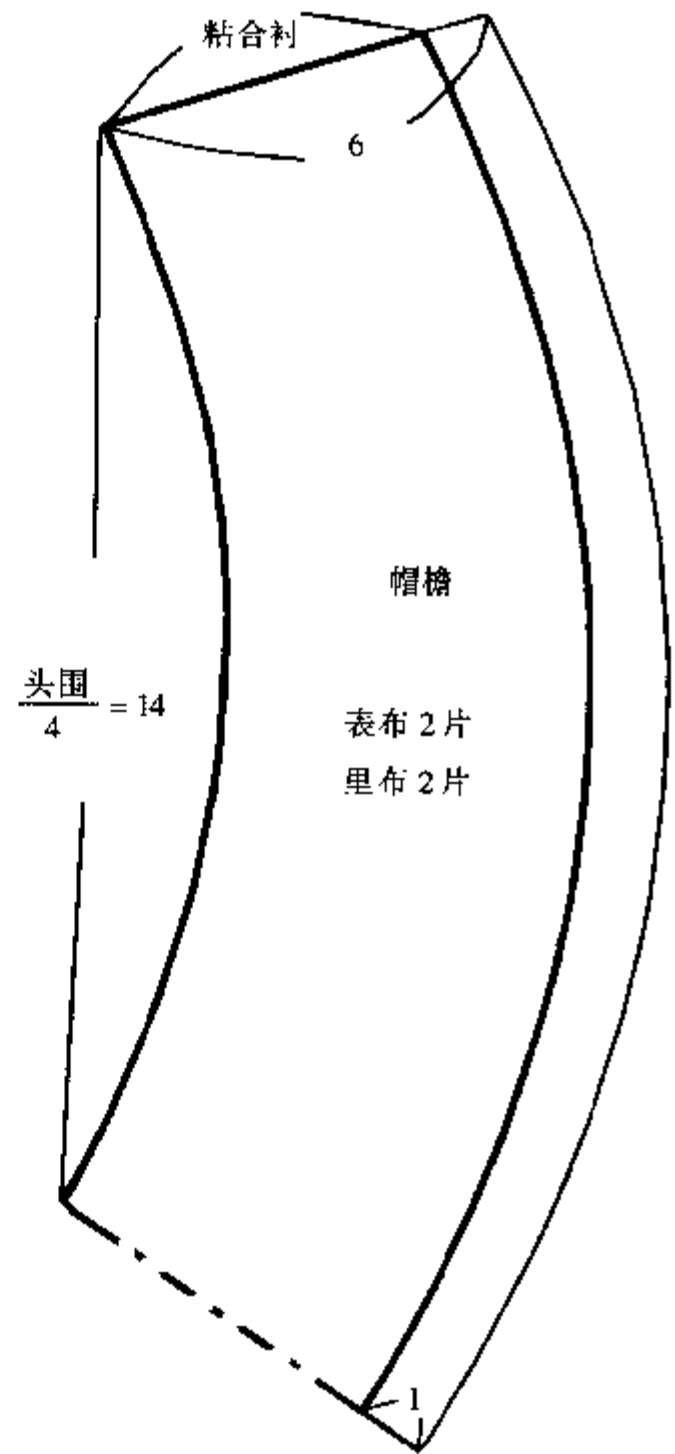
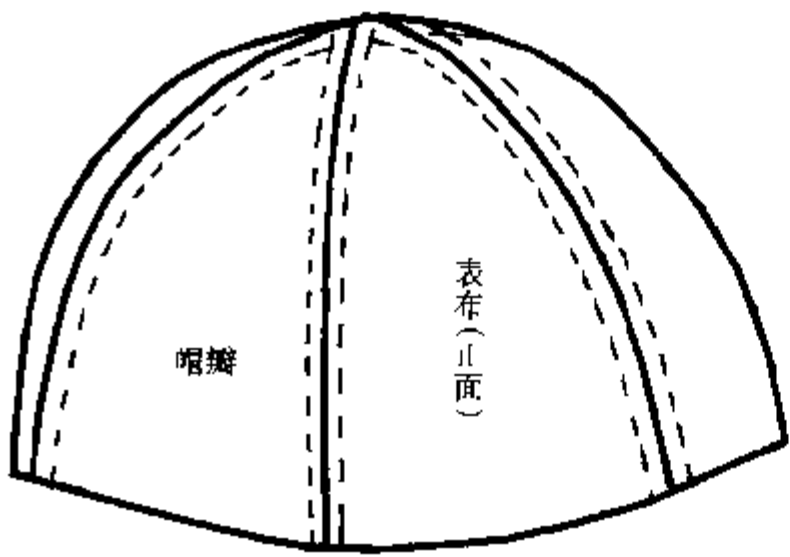

④将帽子的表、里布反面相对套在一起

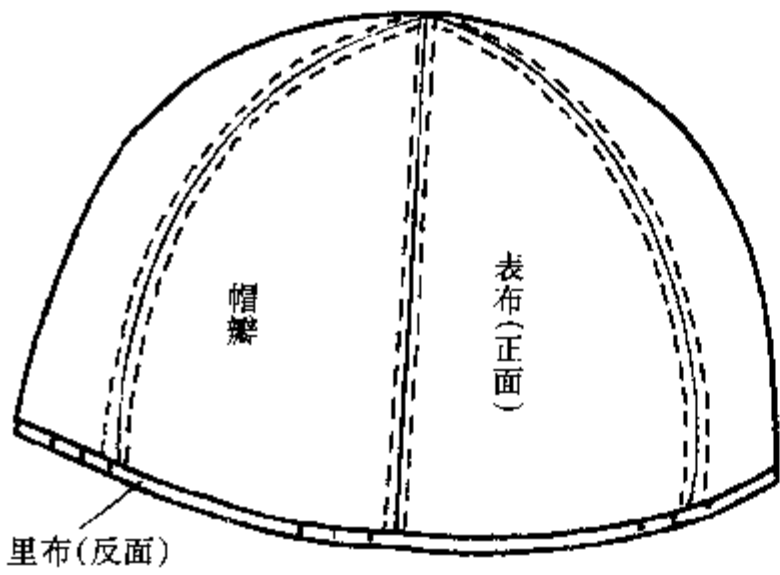

④缝合帽檐

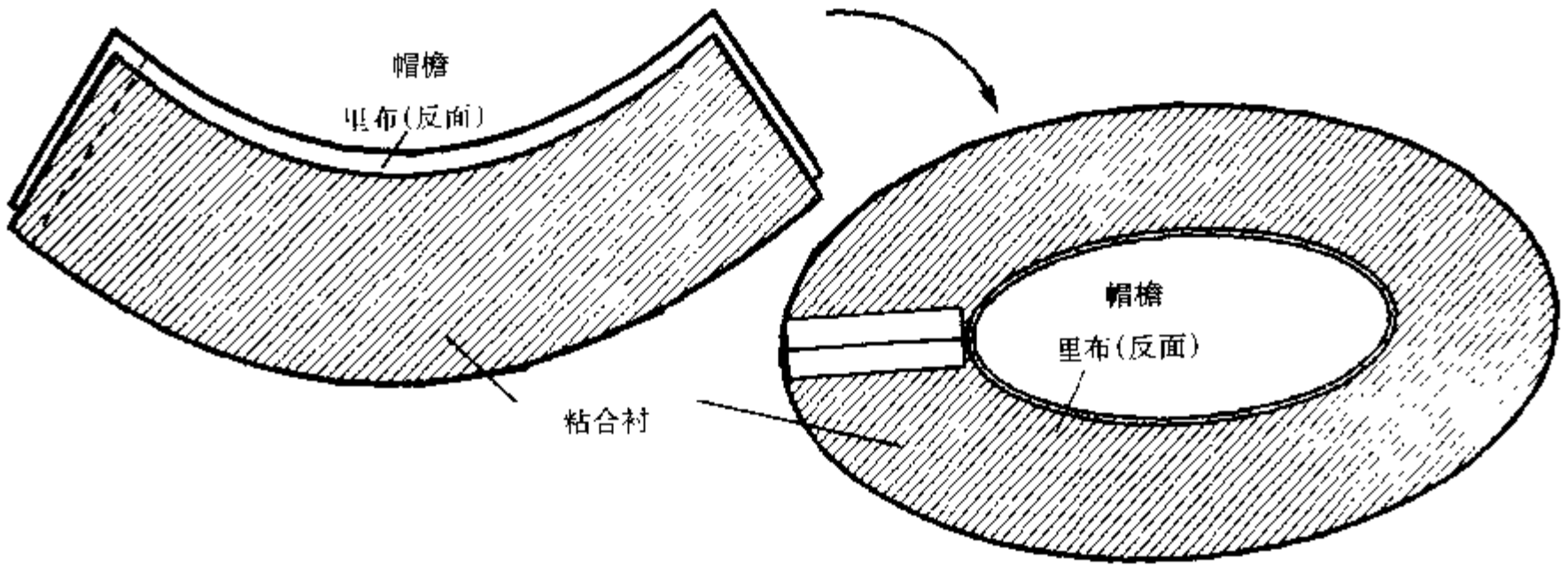

⑤在帽檐 1cm 处缉明线,在帽口处打剪口

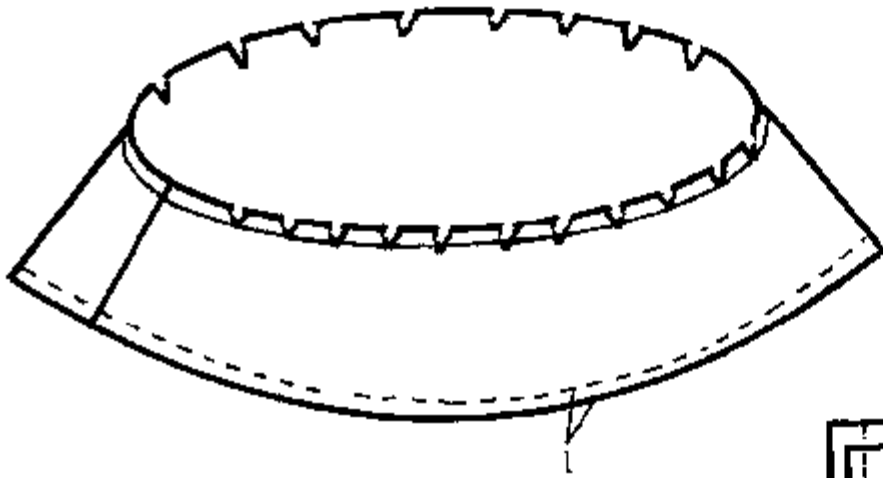

⑥缝合汗口条

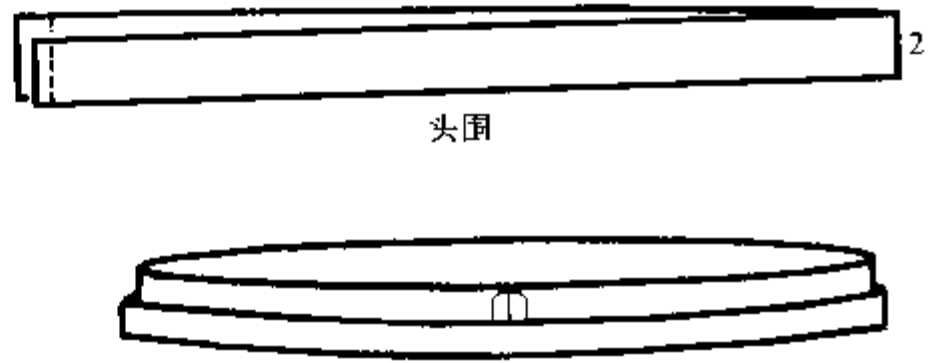

⑦夹缝帽檐

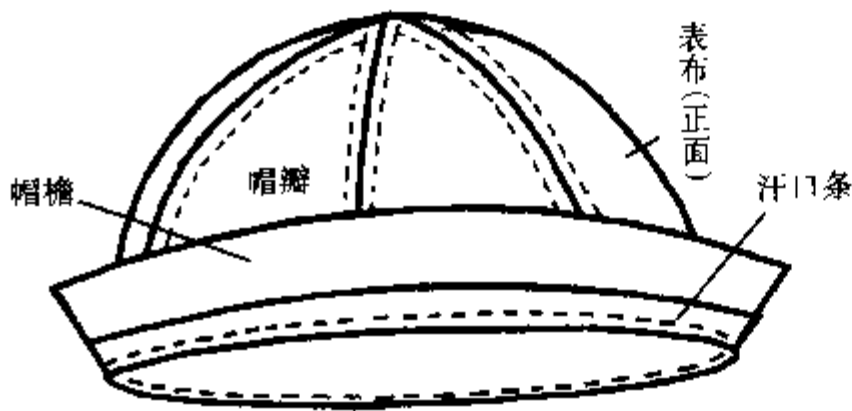

●淑女遮阳蝶结帽

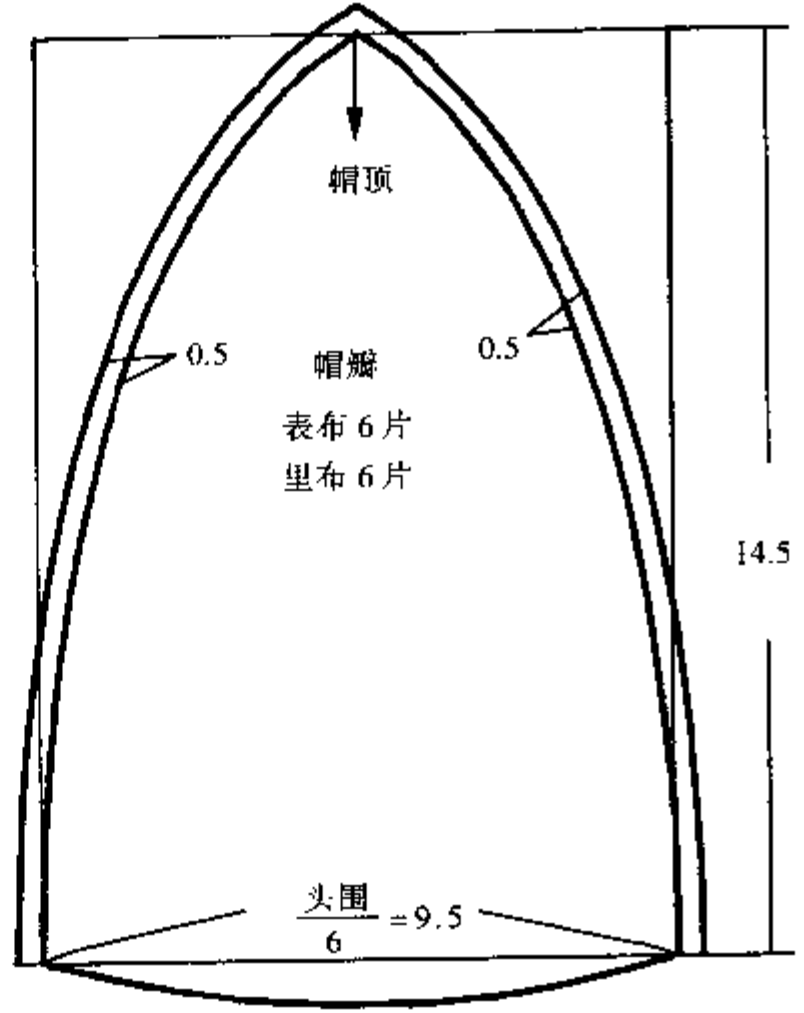

①缝合帽瓣并劈缝熨烫

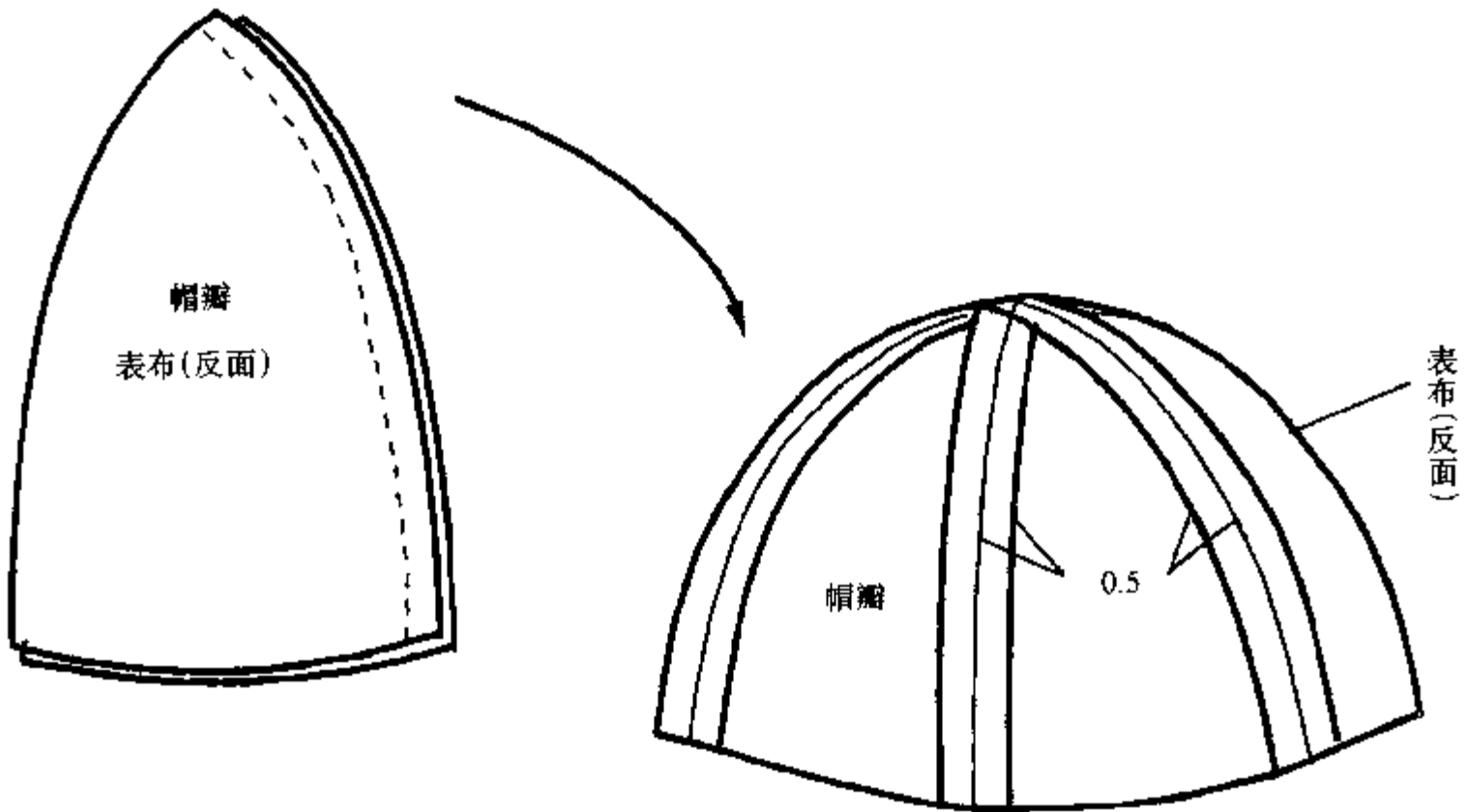

②缝合里布并劈缝熨烫

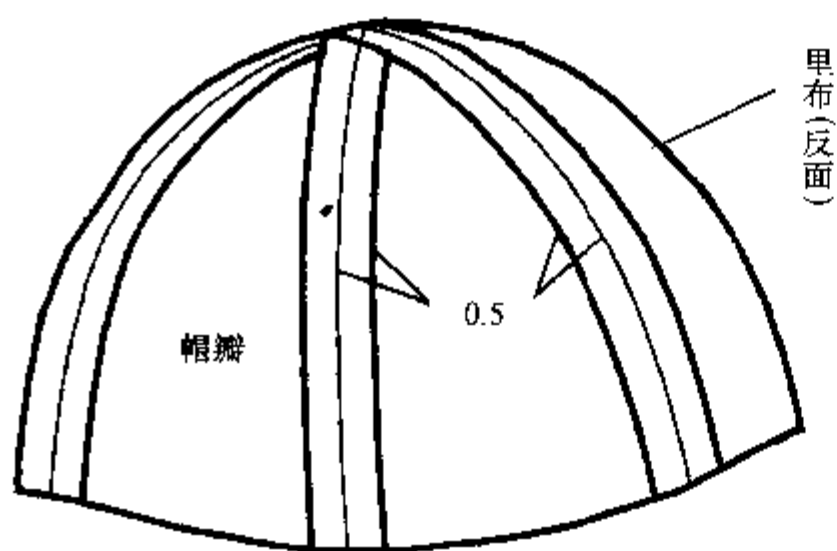
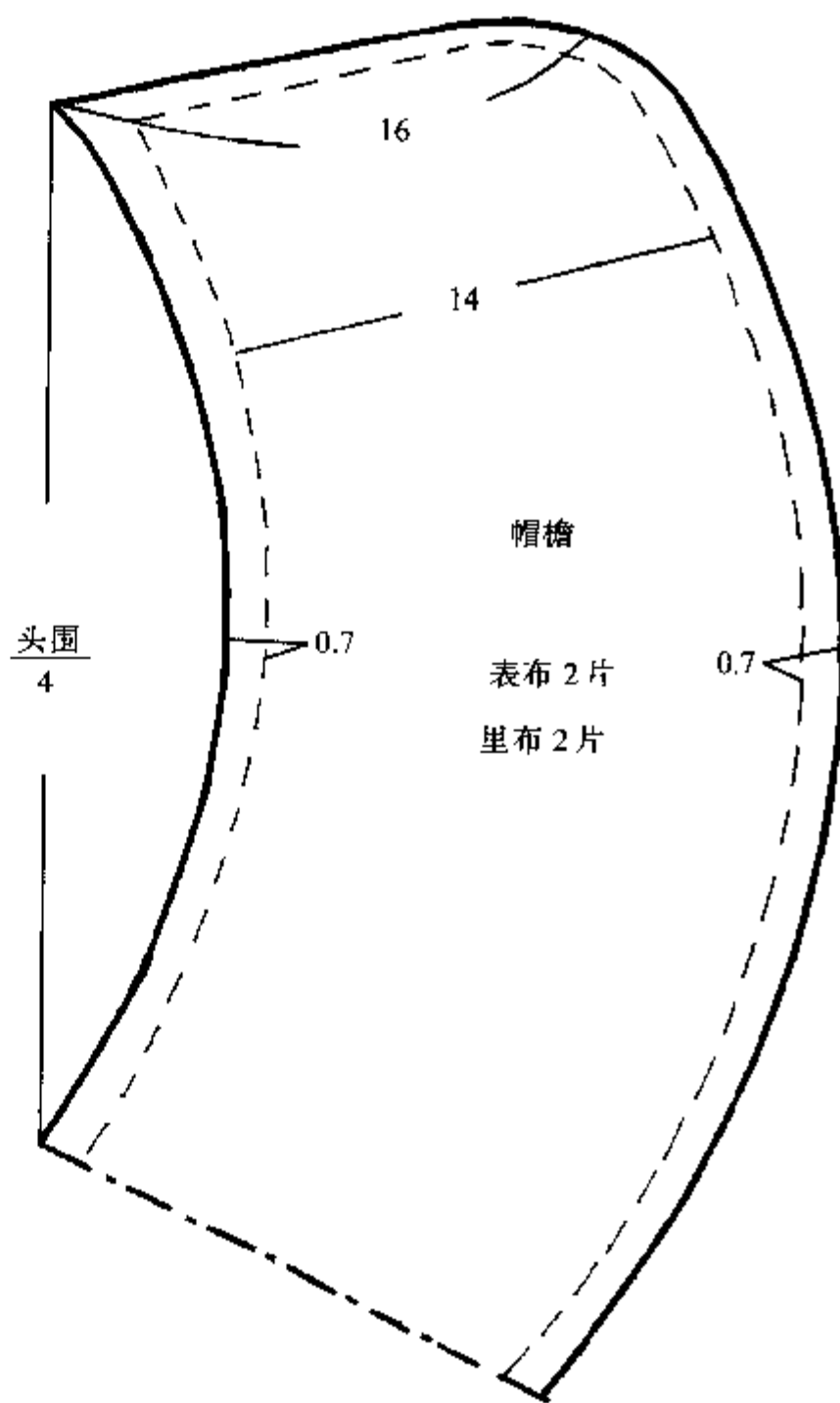
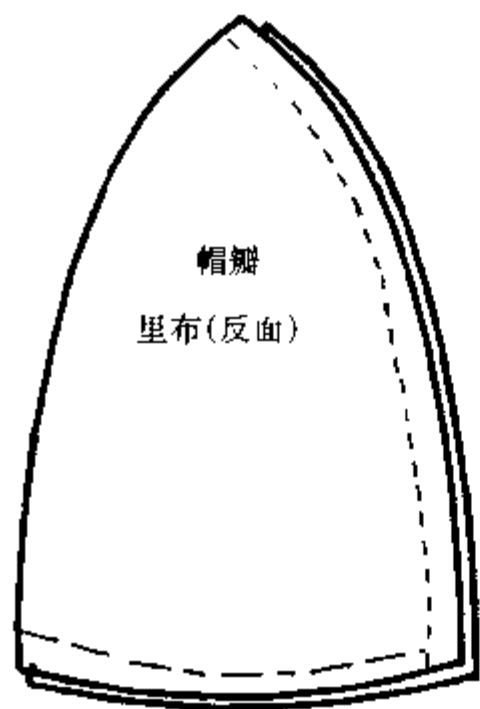

④将帽子表、里布反面相对套在一起

③帽子表布缉明线

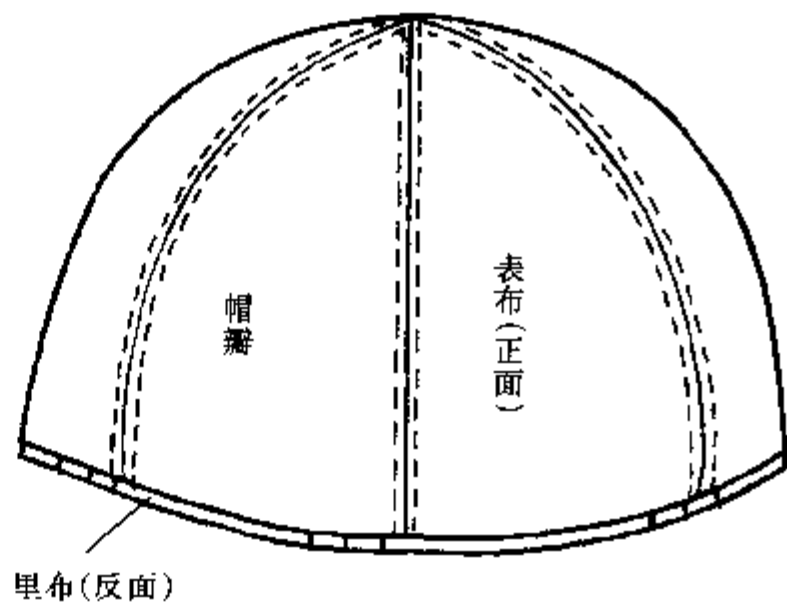
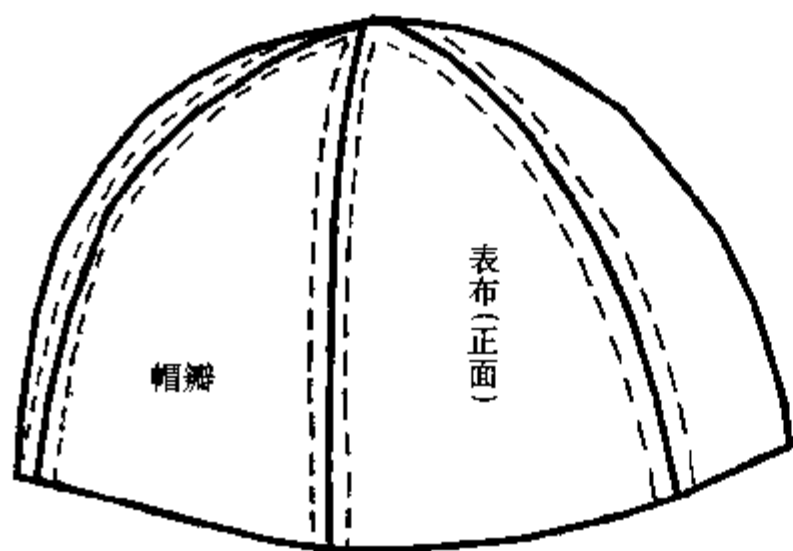

⑤缝合帽檐

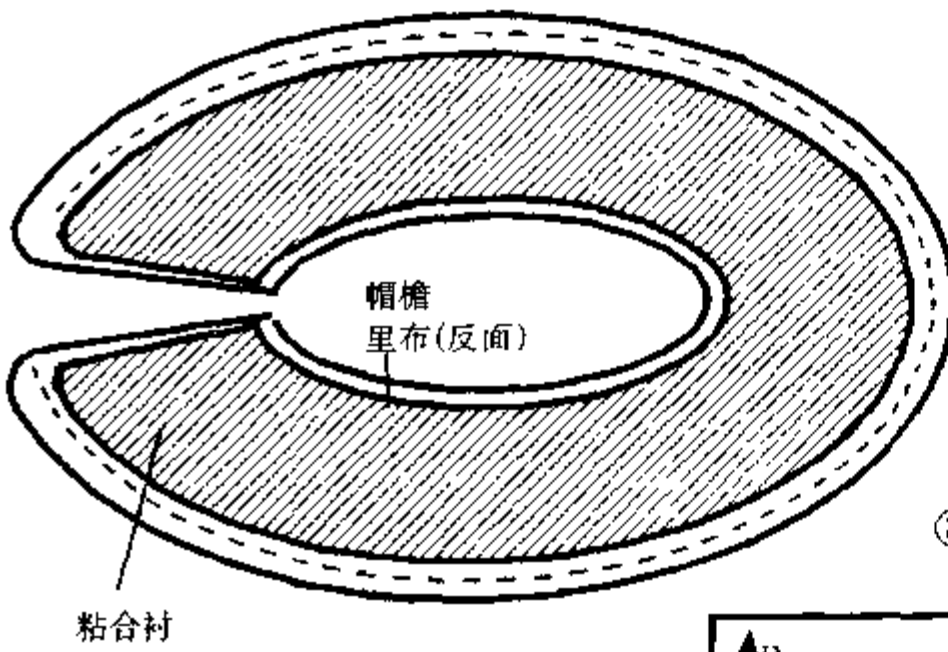

⑦将帽围条折三个顺褶

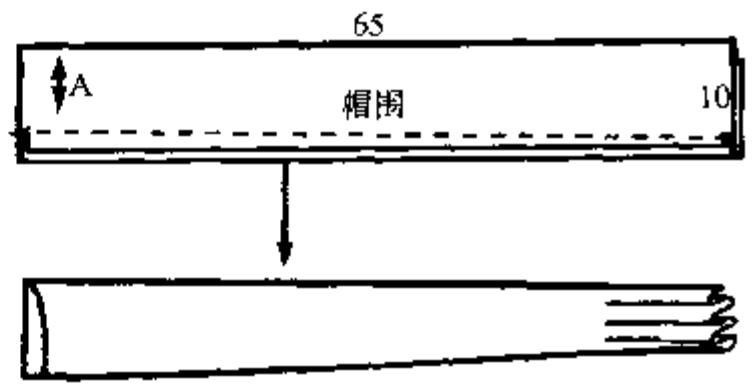

⑧在装饰带中央打三个褶

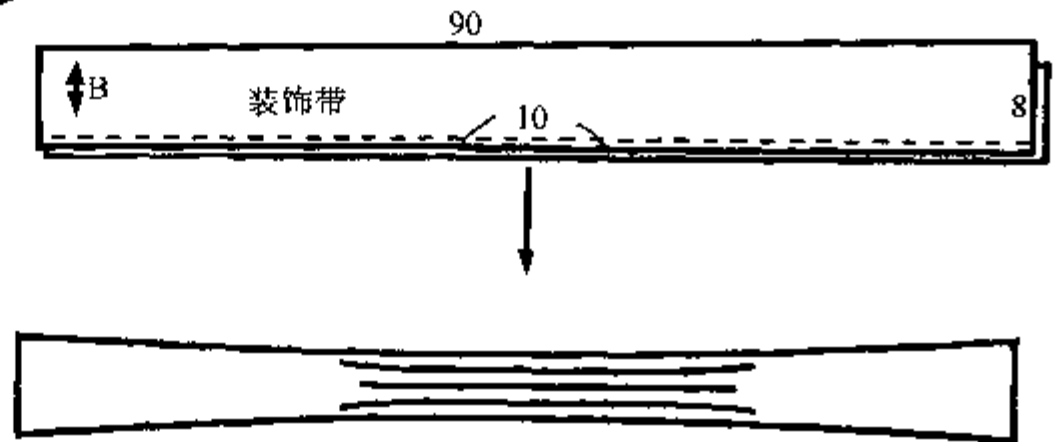

⑥帽檐边缉明线,帽口处打剪口(帽子与帽檐的缝合方法同“少女六片帽”)

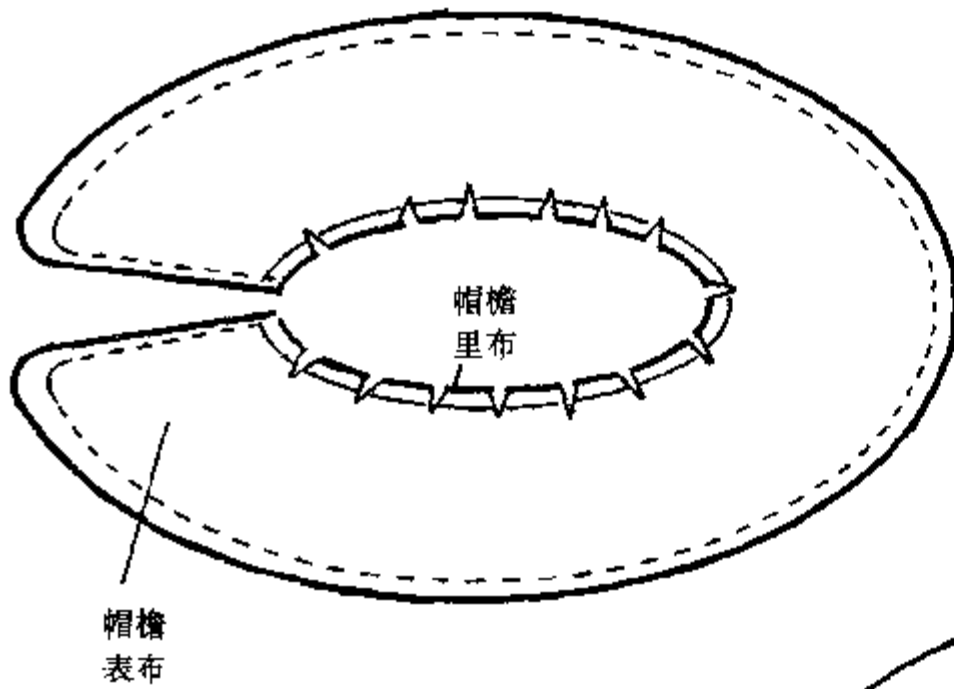

⑨装饰蝶结缝于后中心处

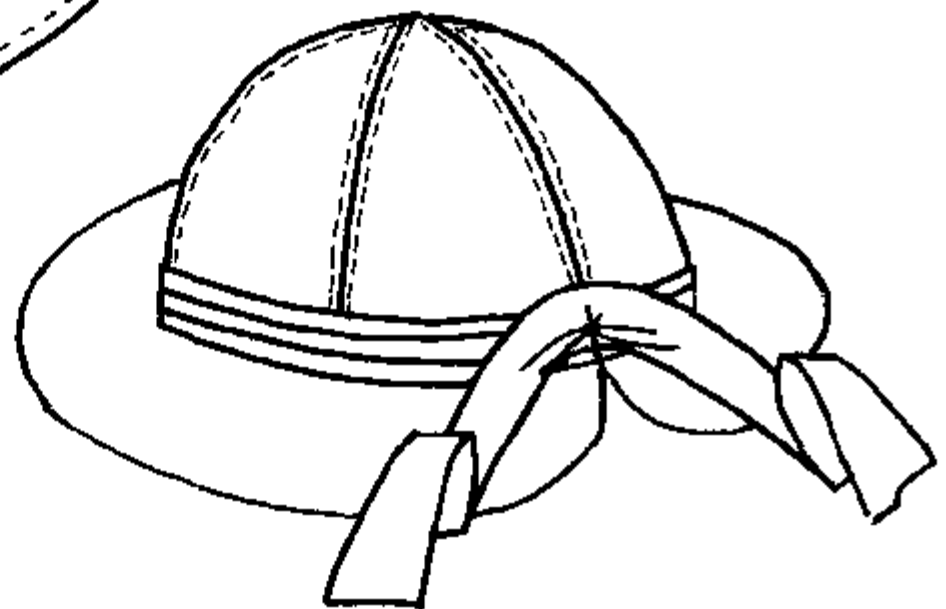



●八片软檐帽

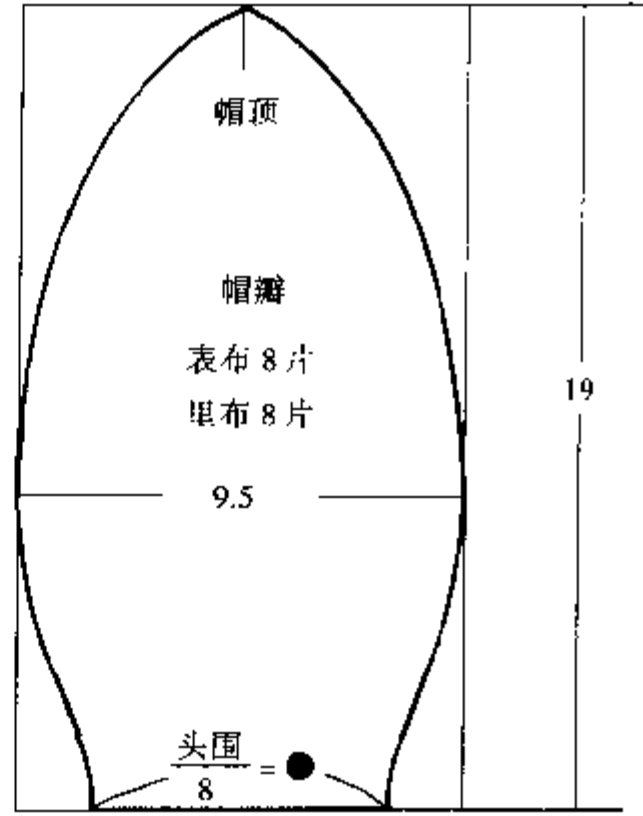

①缝合帽瓣表布,劈缝后翻至正面

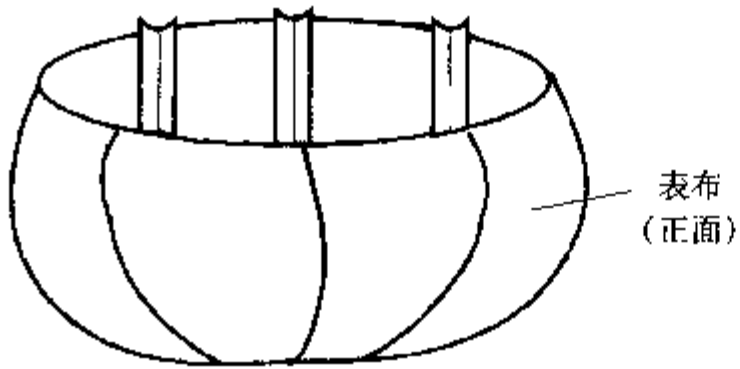
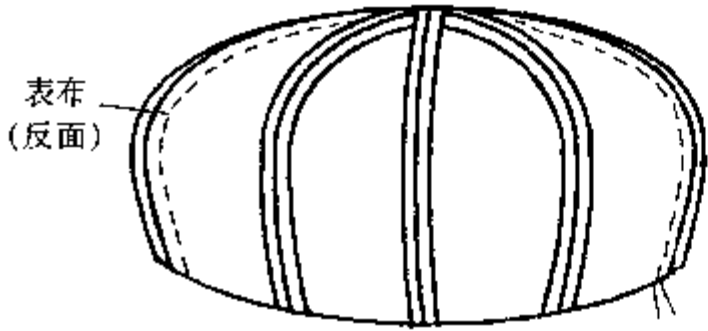

②缝合帽瓣里布并劈缝

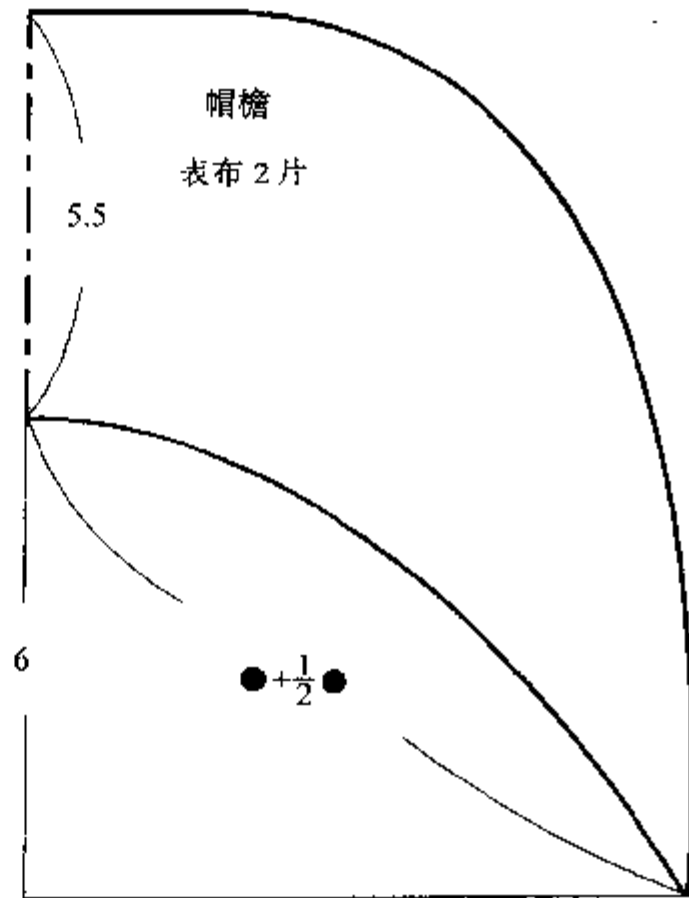
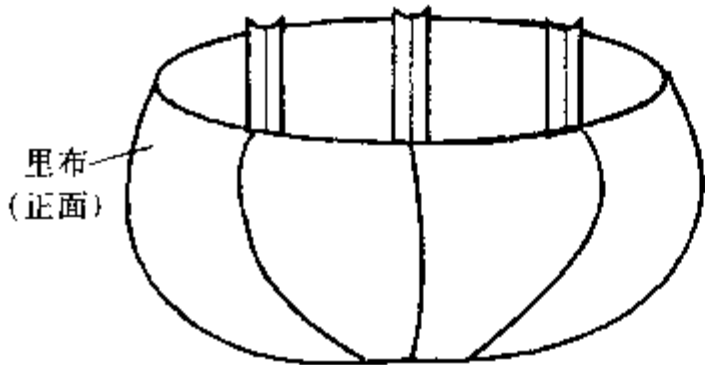

③将帽子的表、里布反面相对套在一起

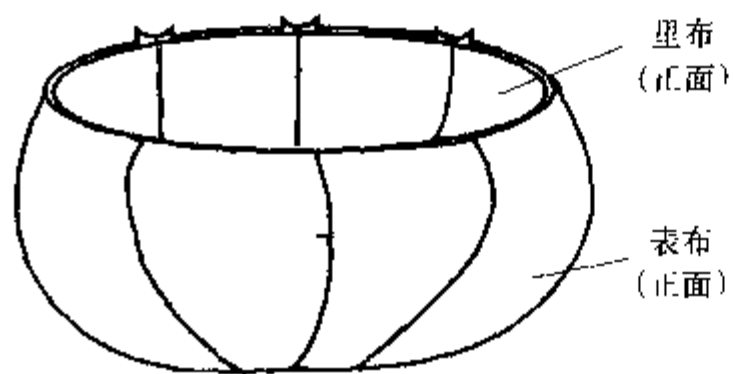

④在帽檐 0.7cm 处缉明线,在帽口处打剪口

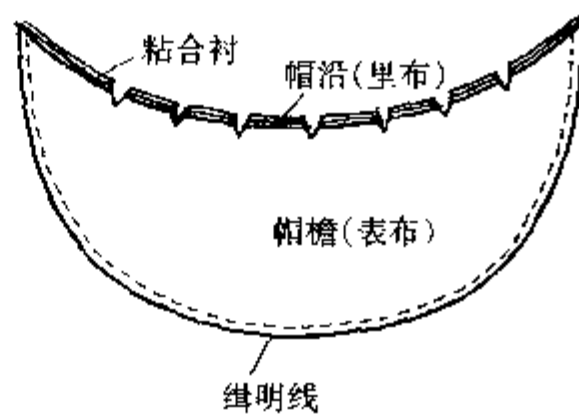

⑤绷缝帽子表、里布与帽檐

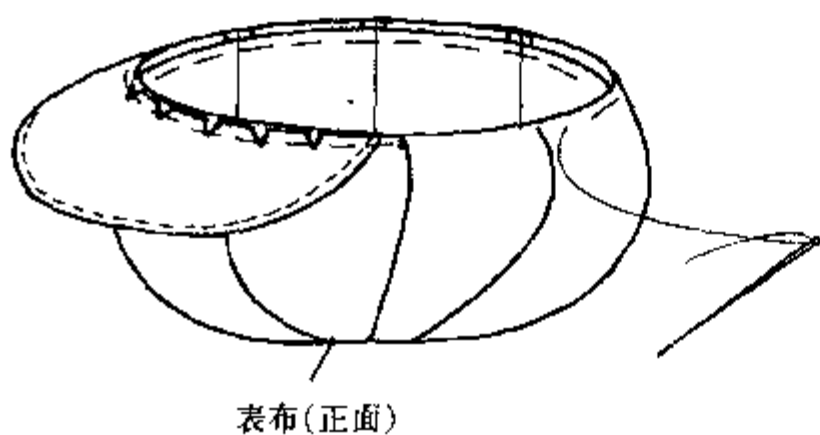

⑥缝合汗口条



⑦帽口缉汗口条

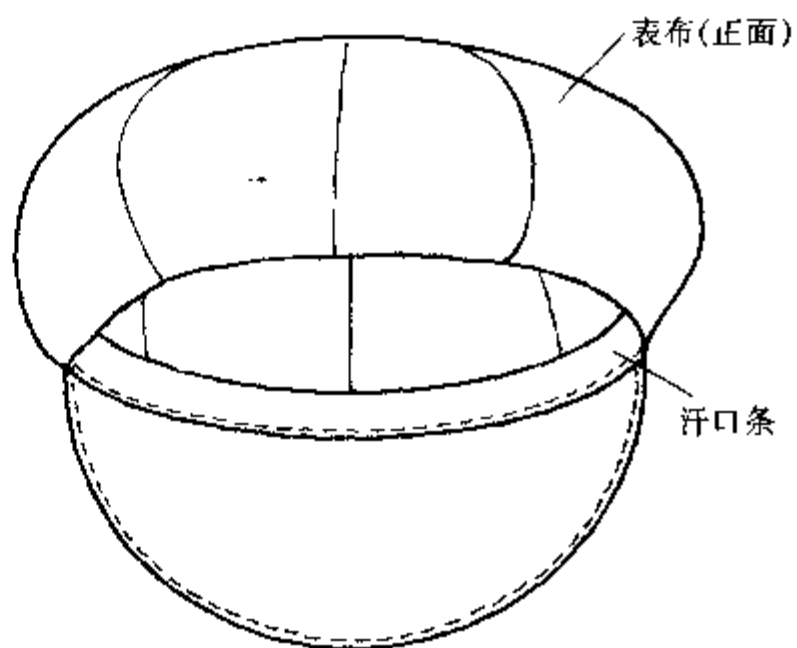
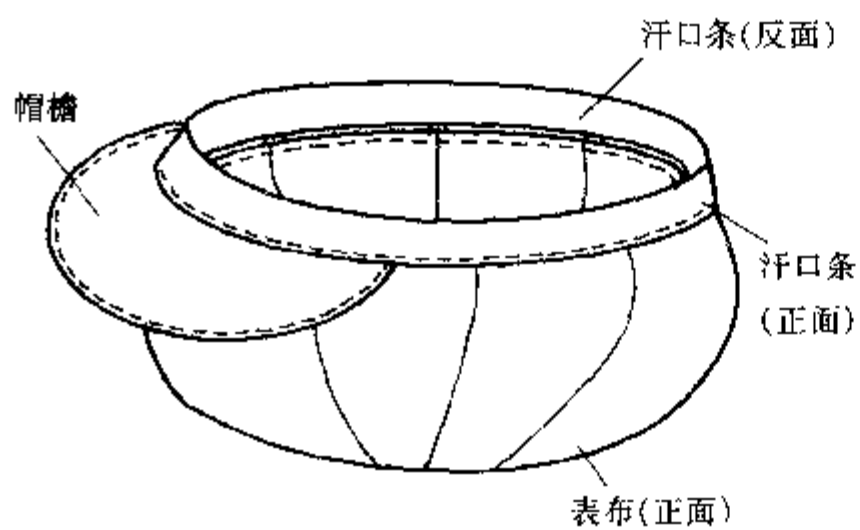

⑧用棉花包好扣子钉于帽顶上。

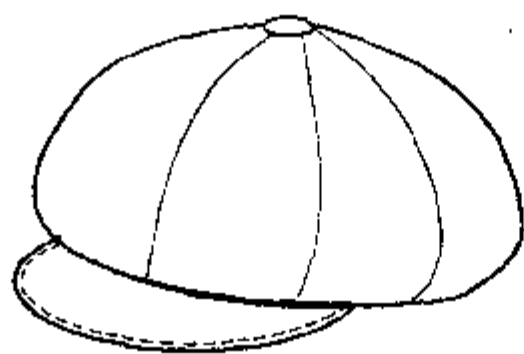
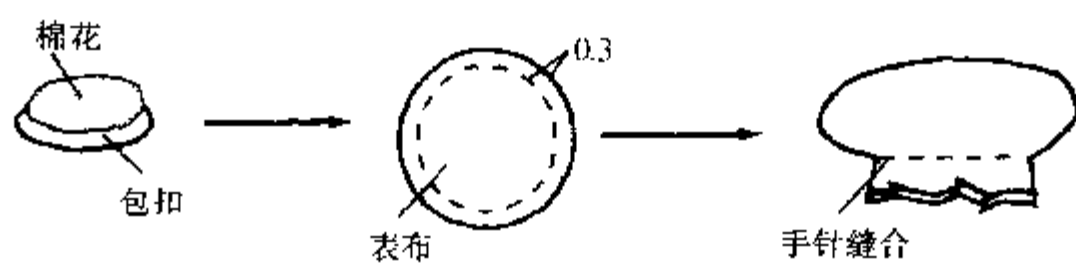

● 金秋休闲贝蕾帽

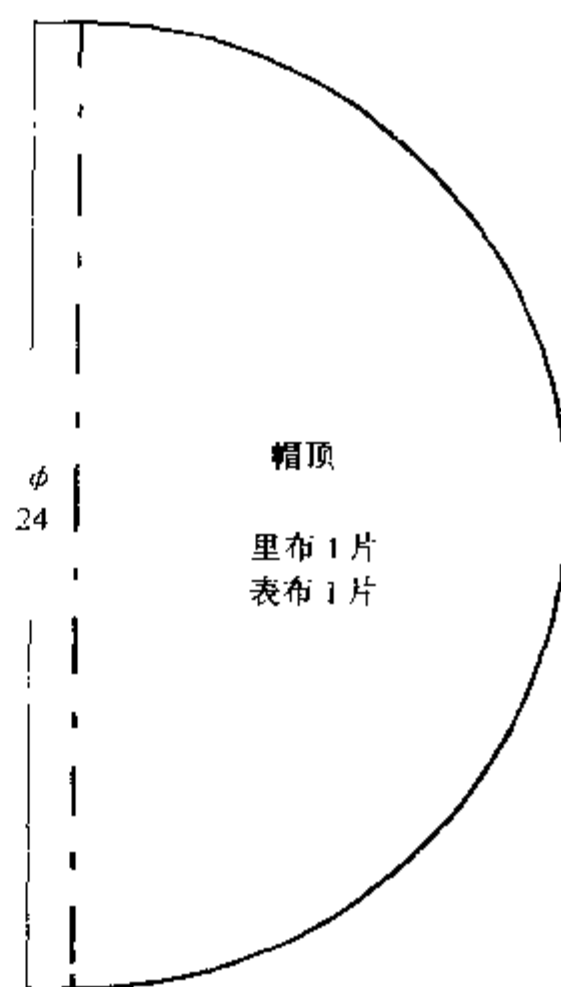

①缝合帽墙表、里布

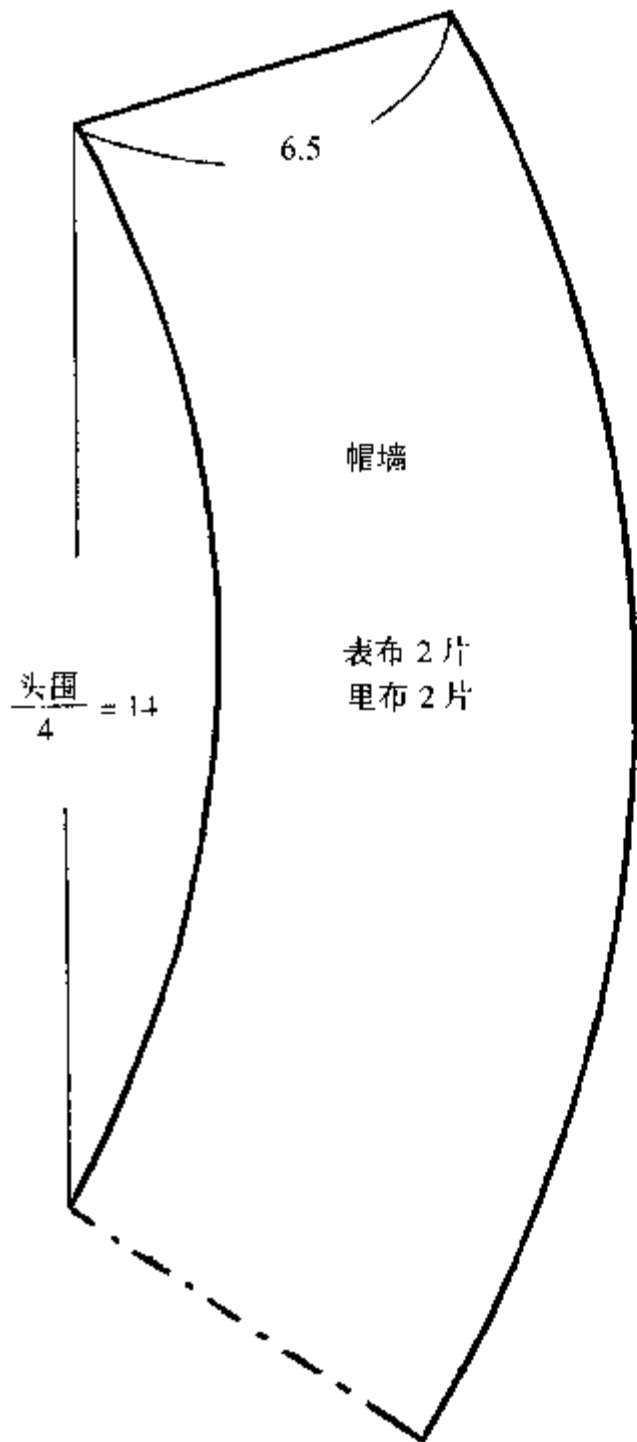
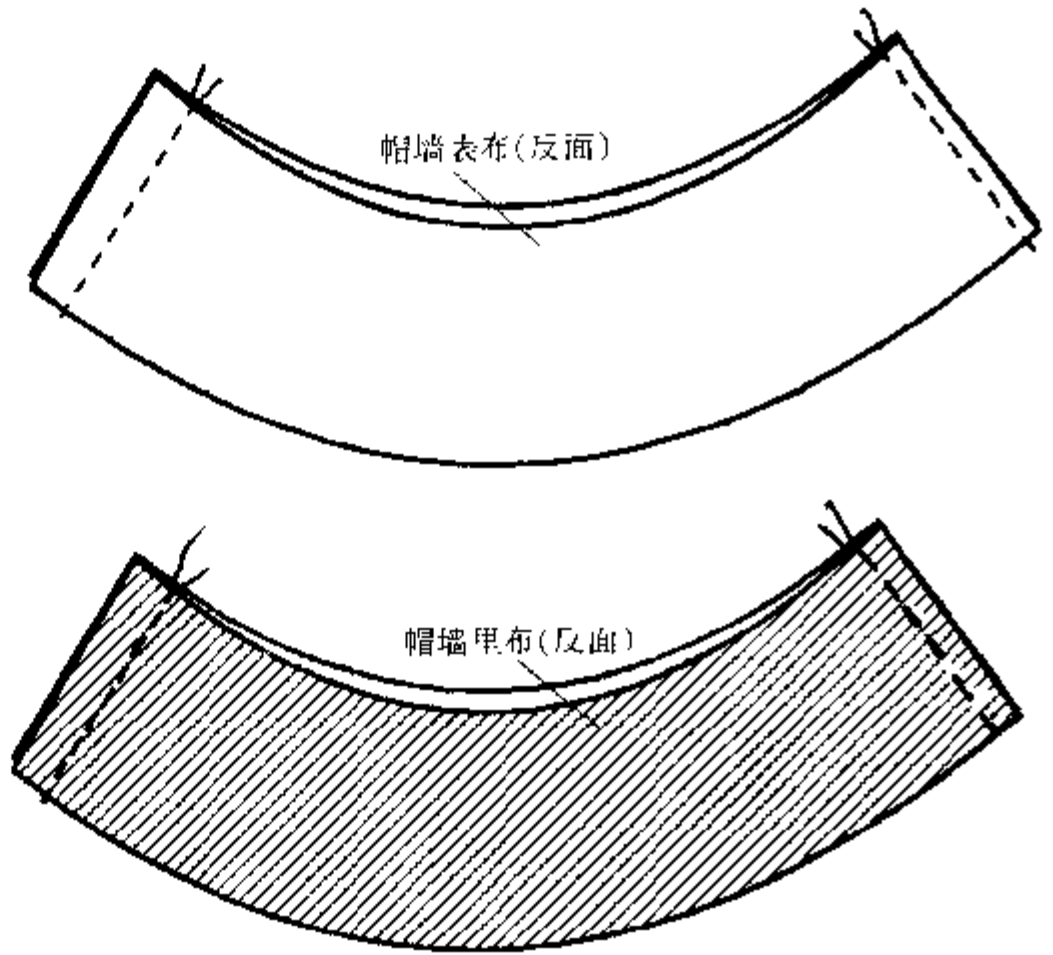

②缝合帽顶表、里布

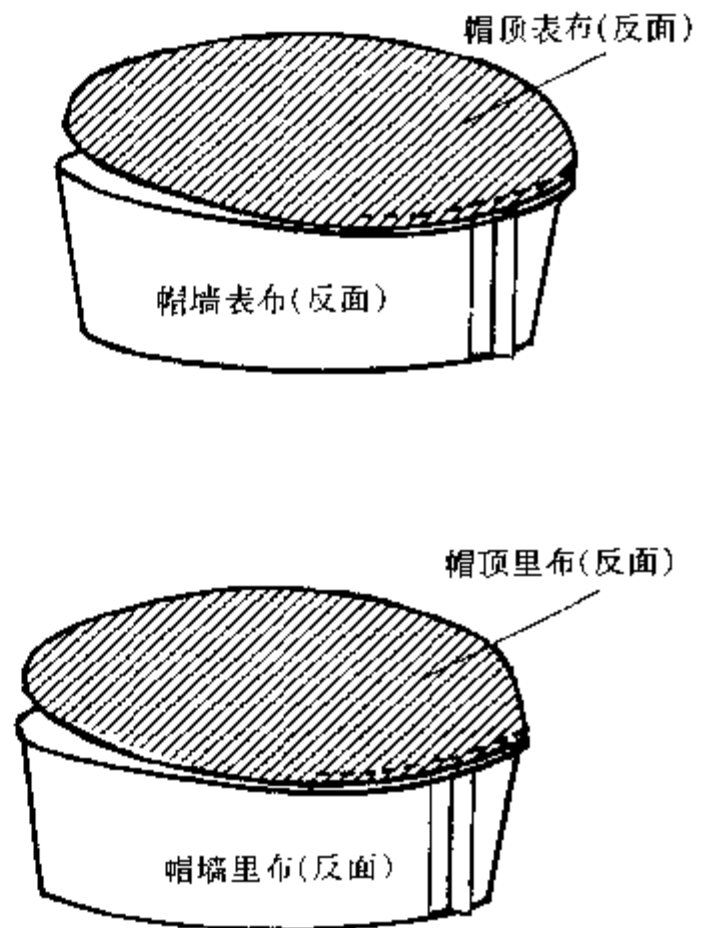

③ 劈开缝份

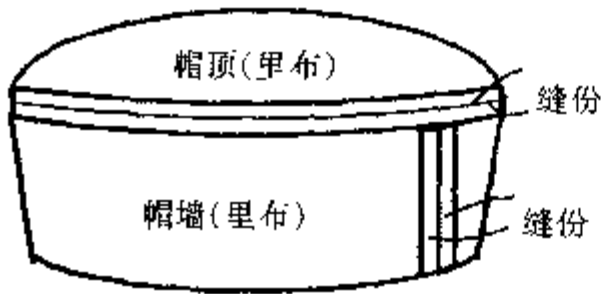
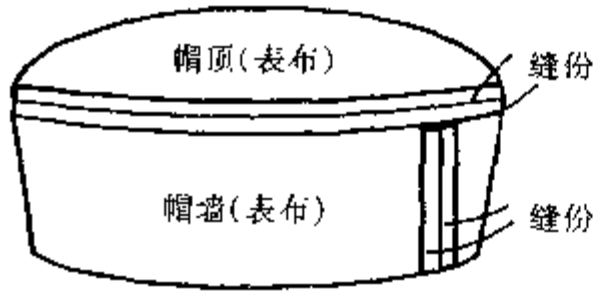

⑤ 将帽表布与里布反面相对并绷缝

帽口

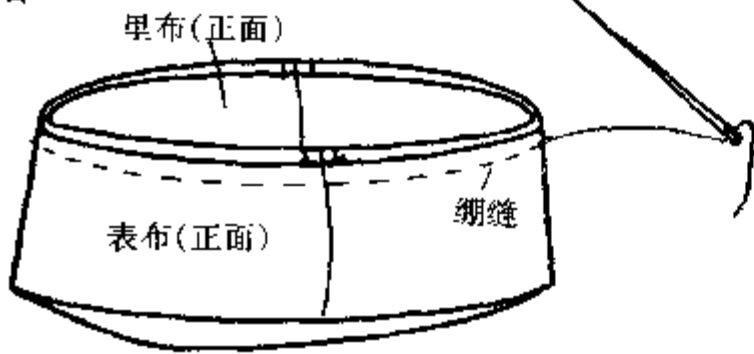

④ 绷缝表、里布的帽顶缝份

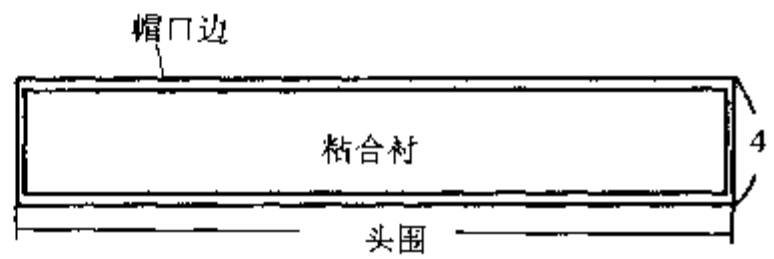
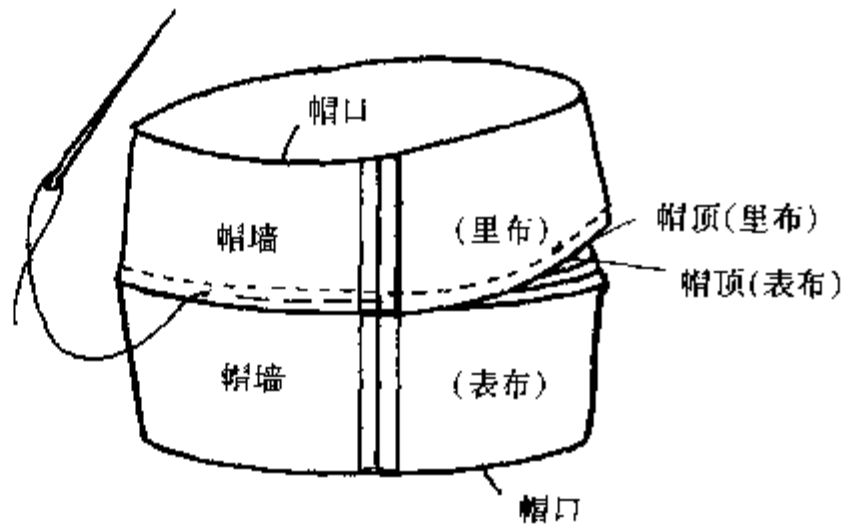

⑦ 将帽口边与帽墙缝合, 先缝帽口边里布, 然后翻至正面盖住缝线 0.2cm, 再沿边缘 0.1cm 处缉缝

⑥ 缝合帽口边并分开缝份

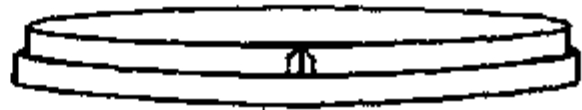

⑧ 完成帽边的缝合

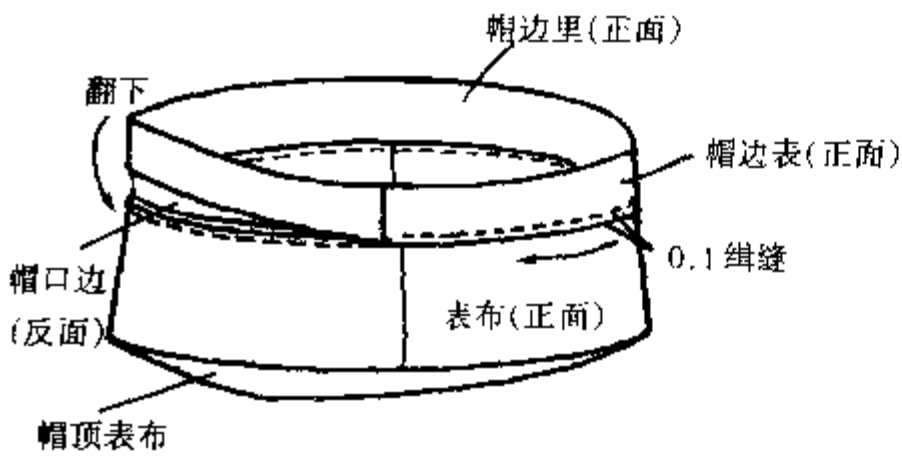
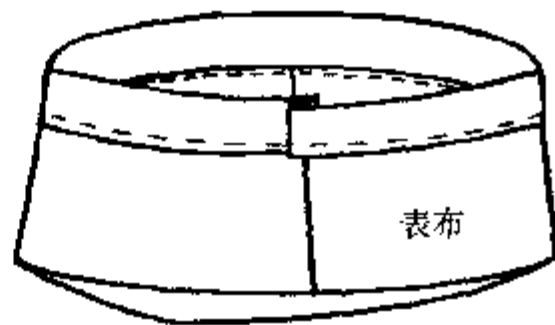



● 潇洒棒球帽

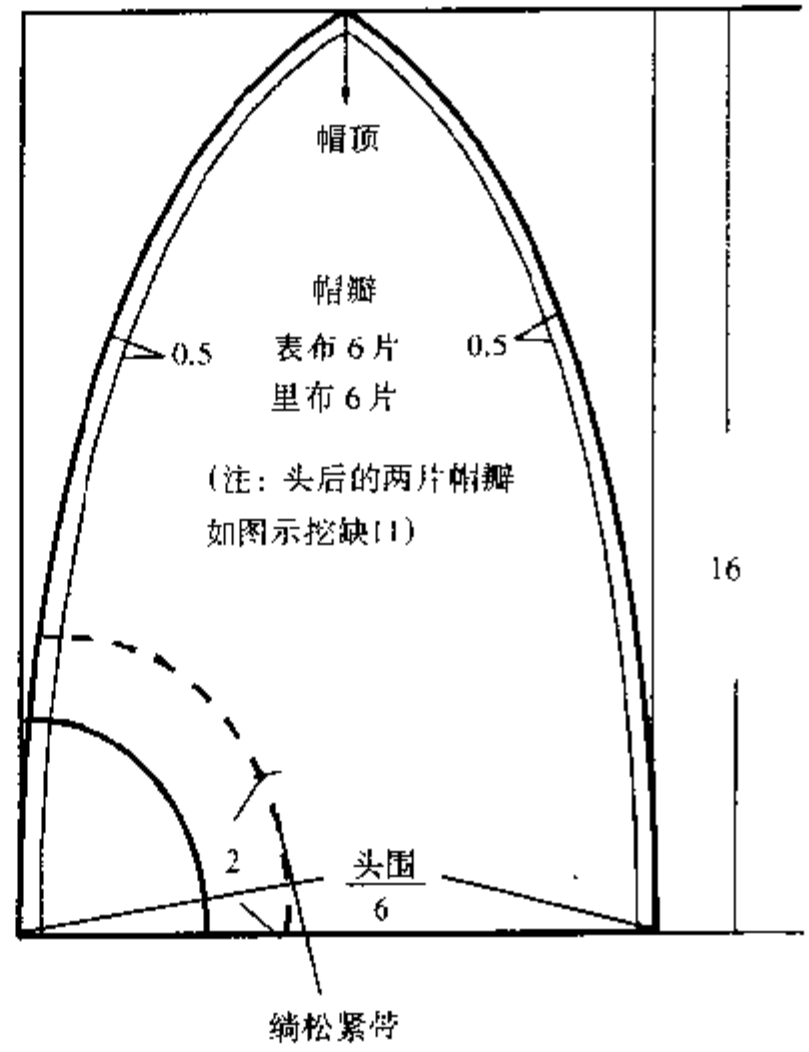

① 缝合帽瓣并劈缝熨烫

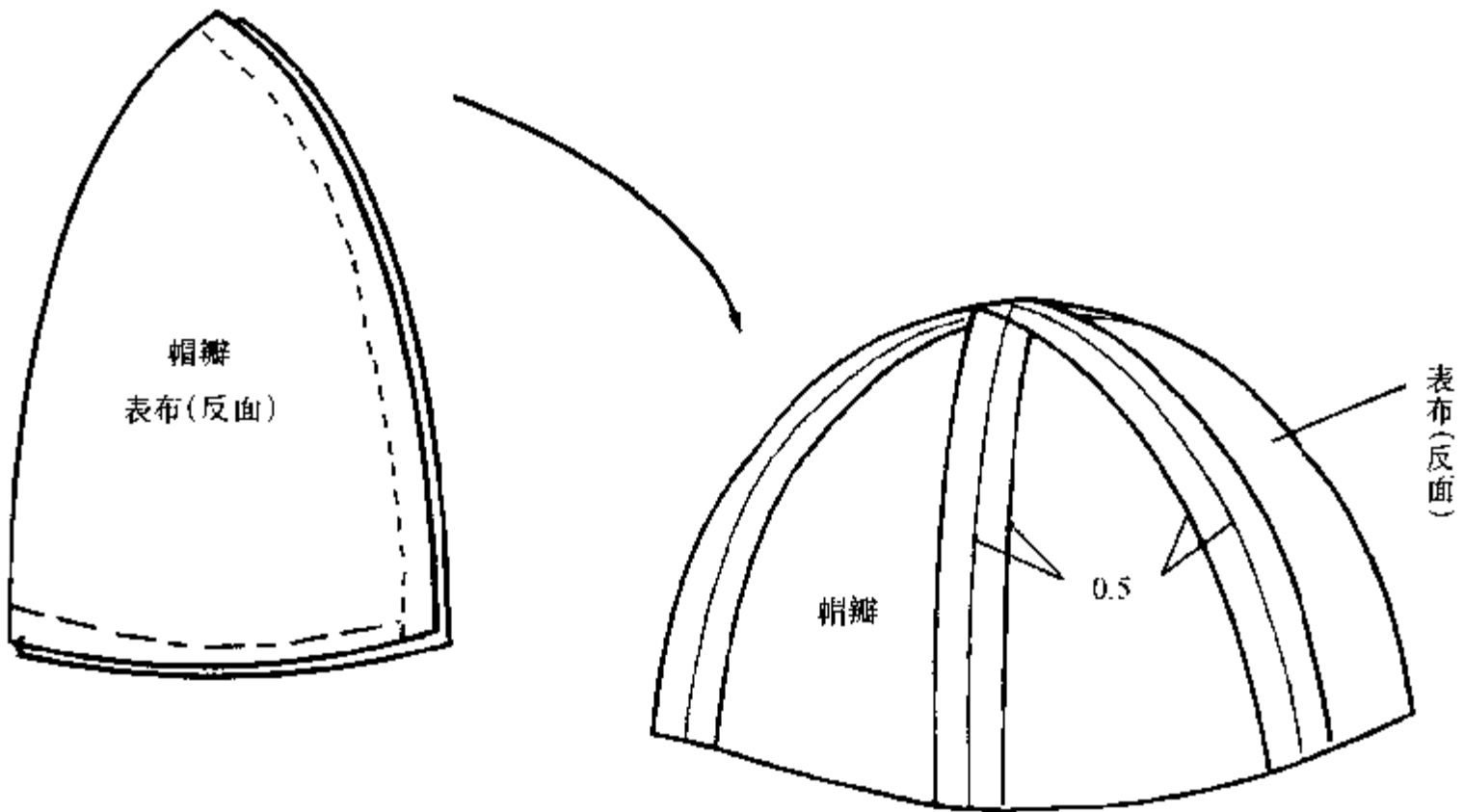

②缝合里布并劈缝熨烫

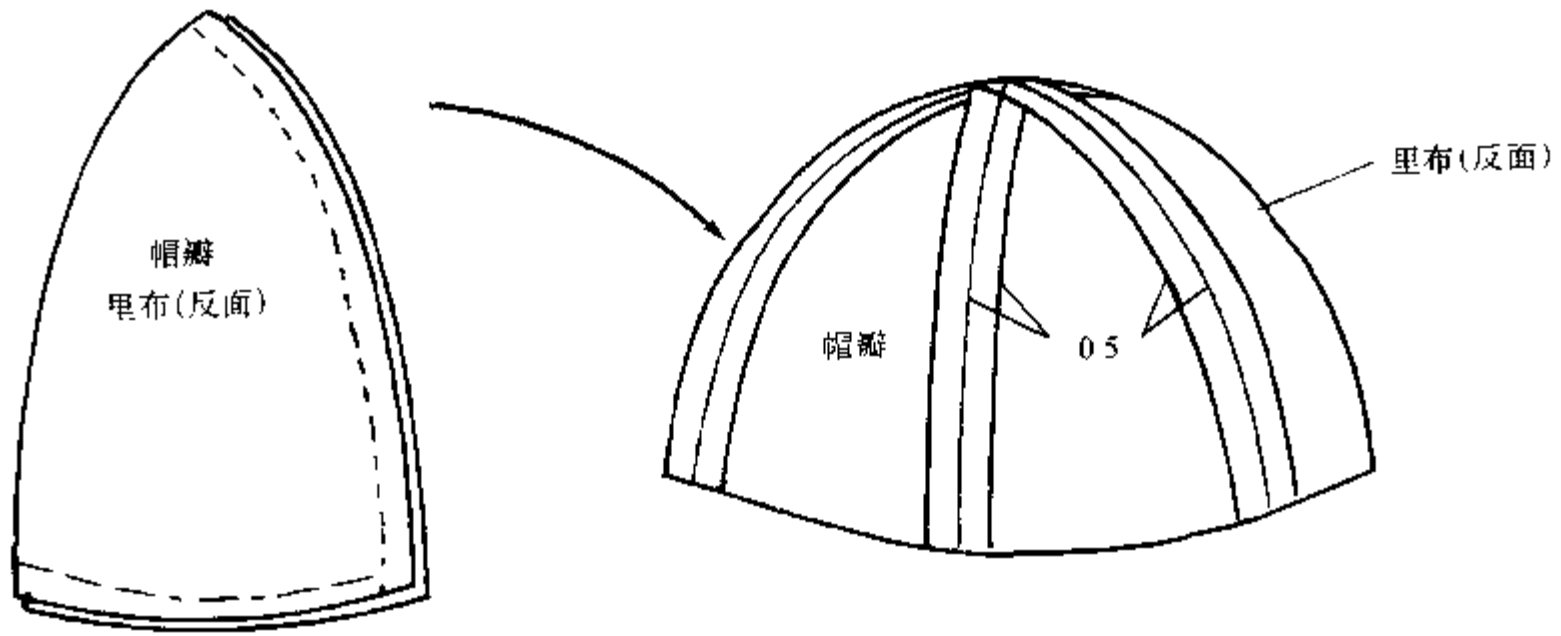

③帽子表布缉明线

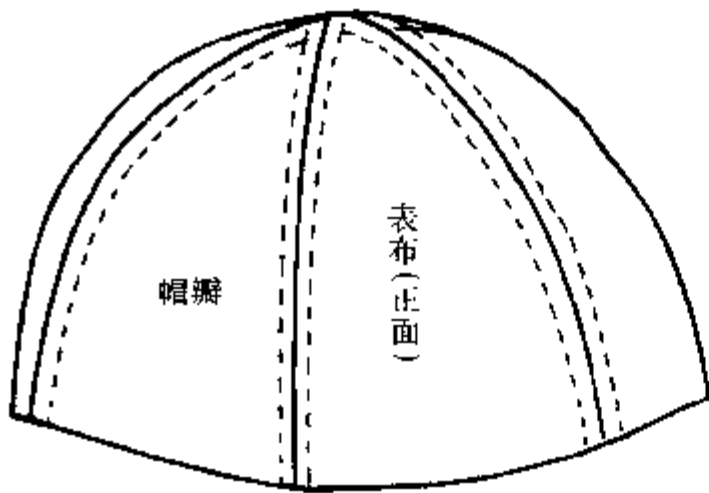

④将帽子表、里布反面相对套在一起

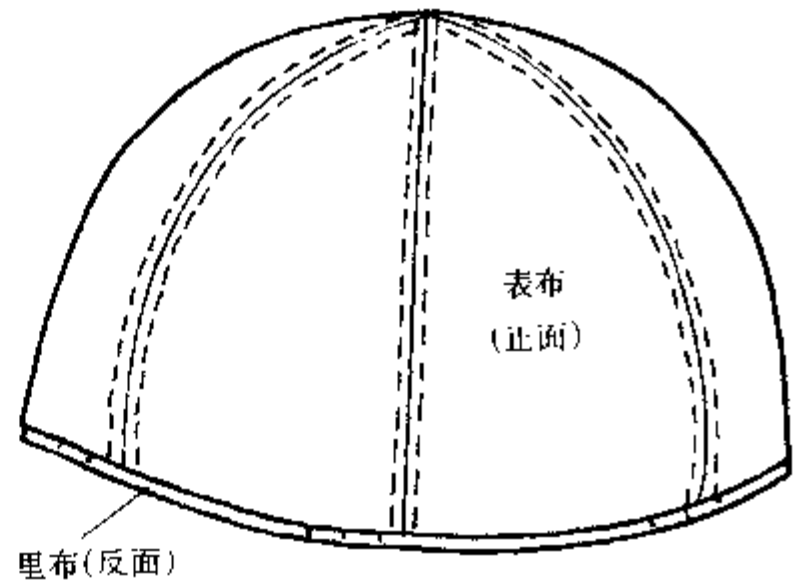

⑤松紧孔处缉松紧带并加贴边

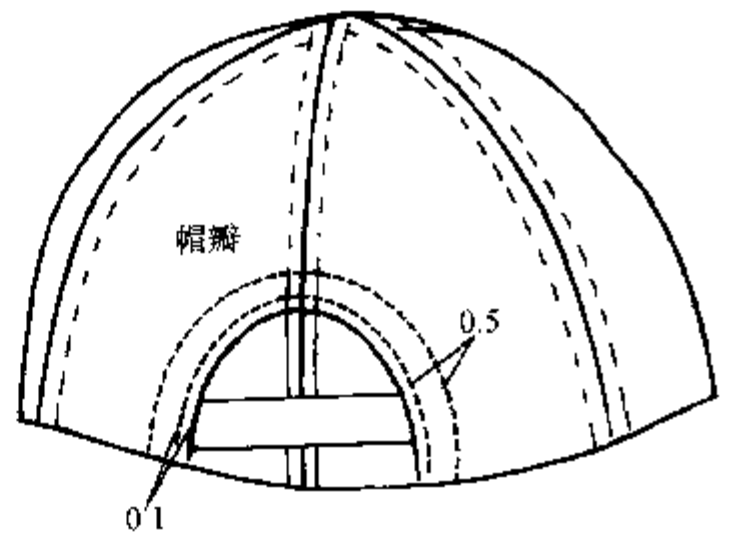
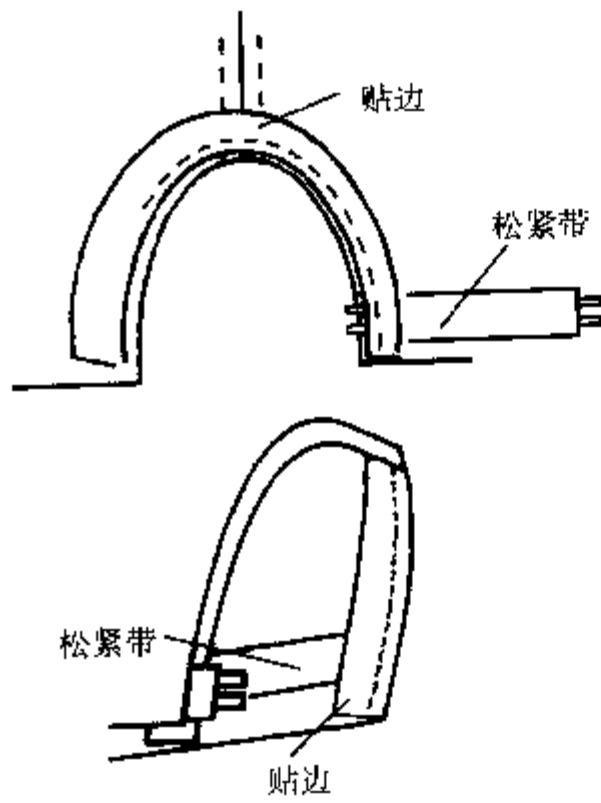

⑥在帽檐0.7cm处缉明线,帽口处打剪口

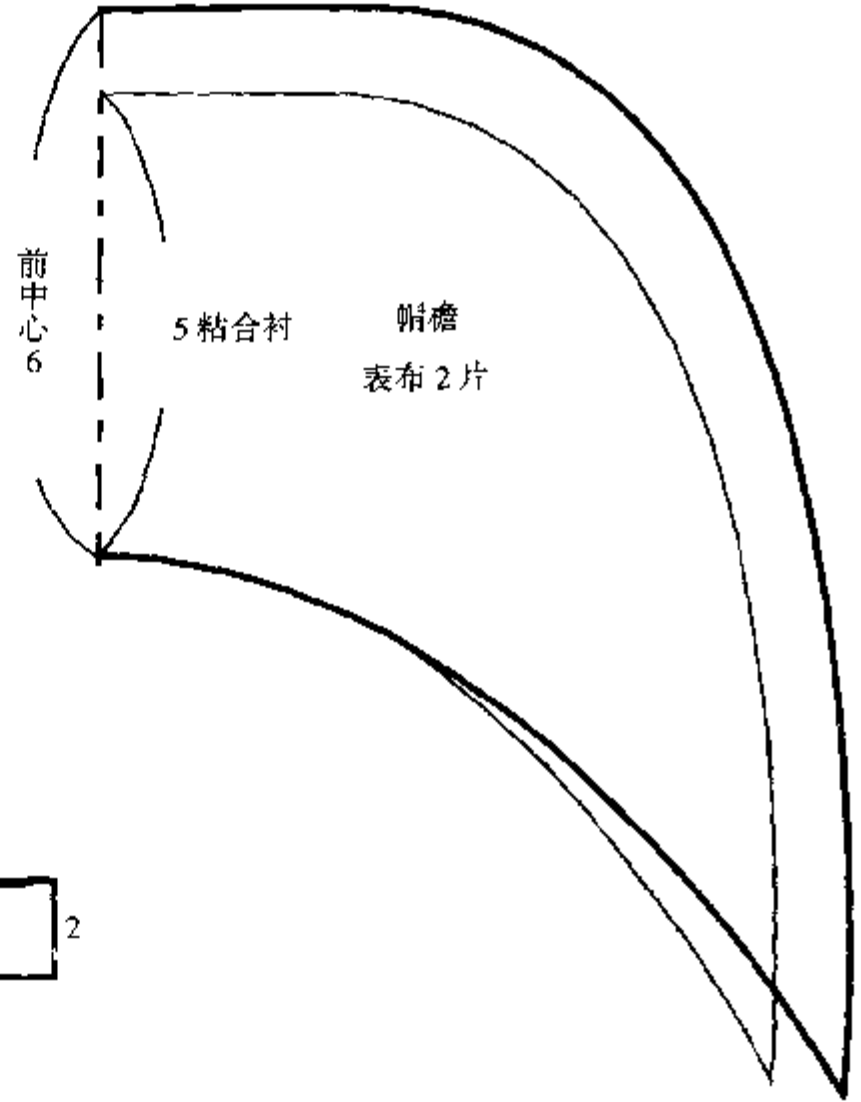
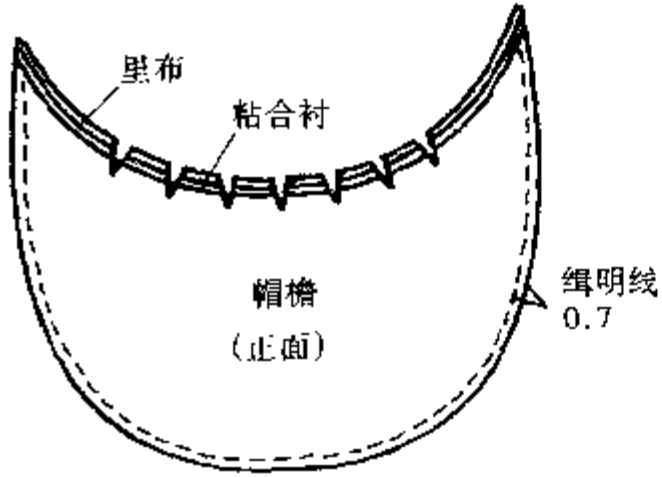

⑦缝合汗口条

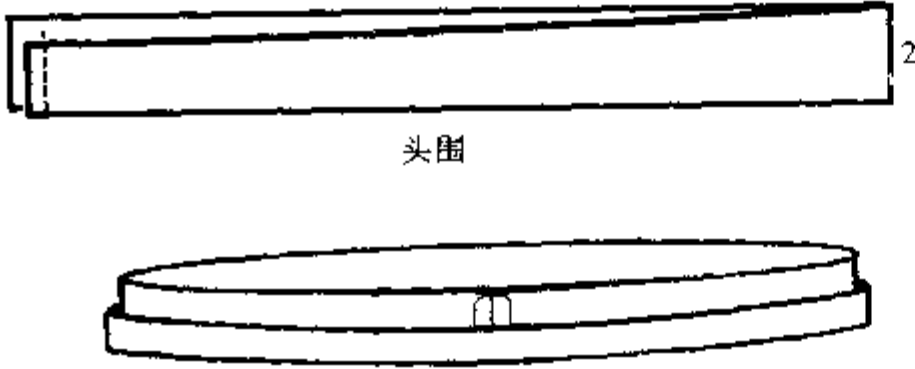

⑧夹缝帽檐

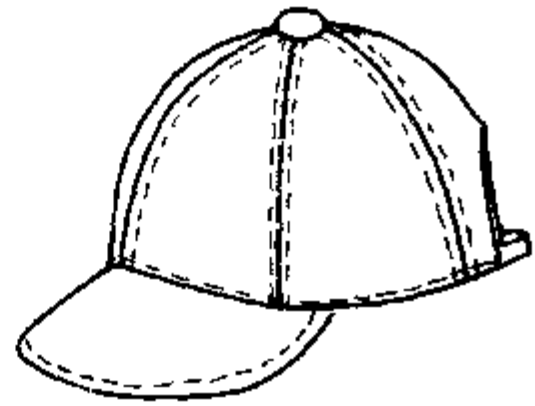
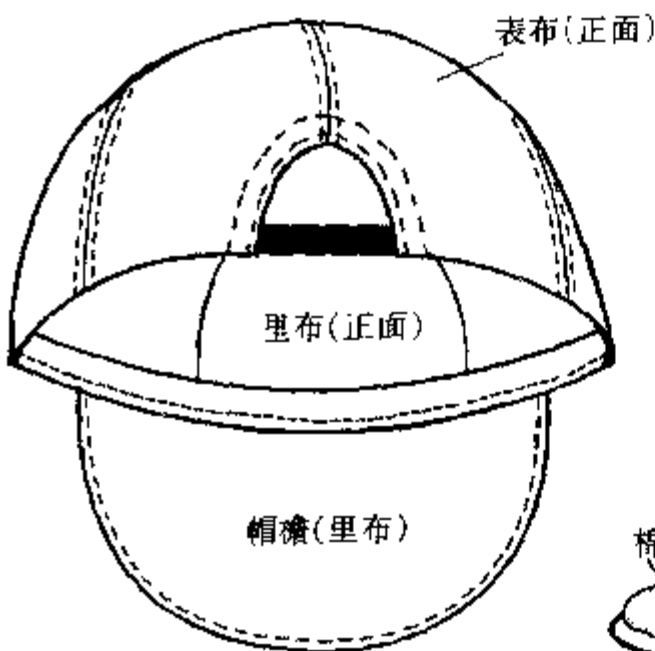

⑨用棉花包好扣子钉于帽顶上

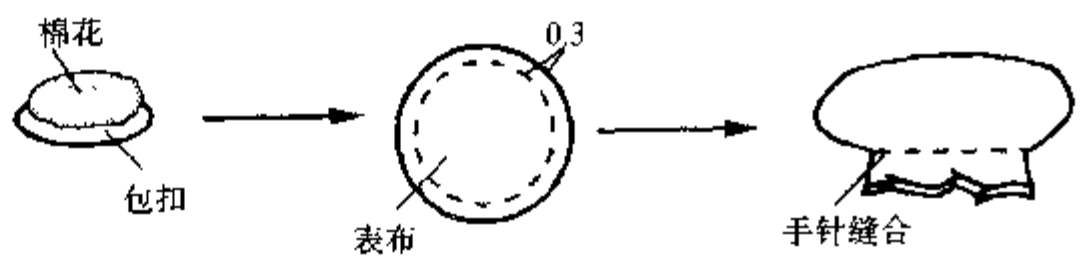



● 装饰珠花骑士帽

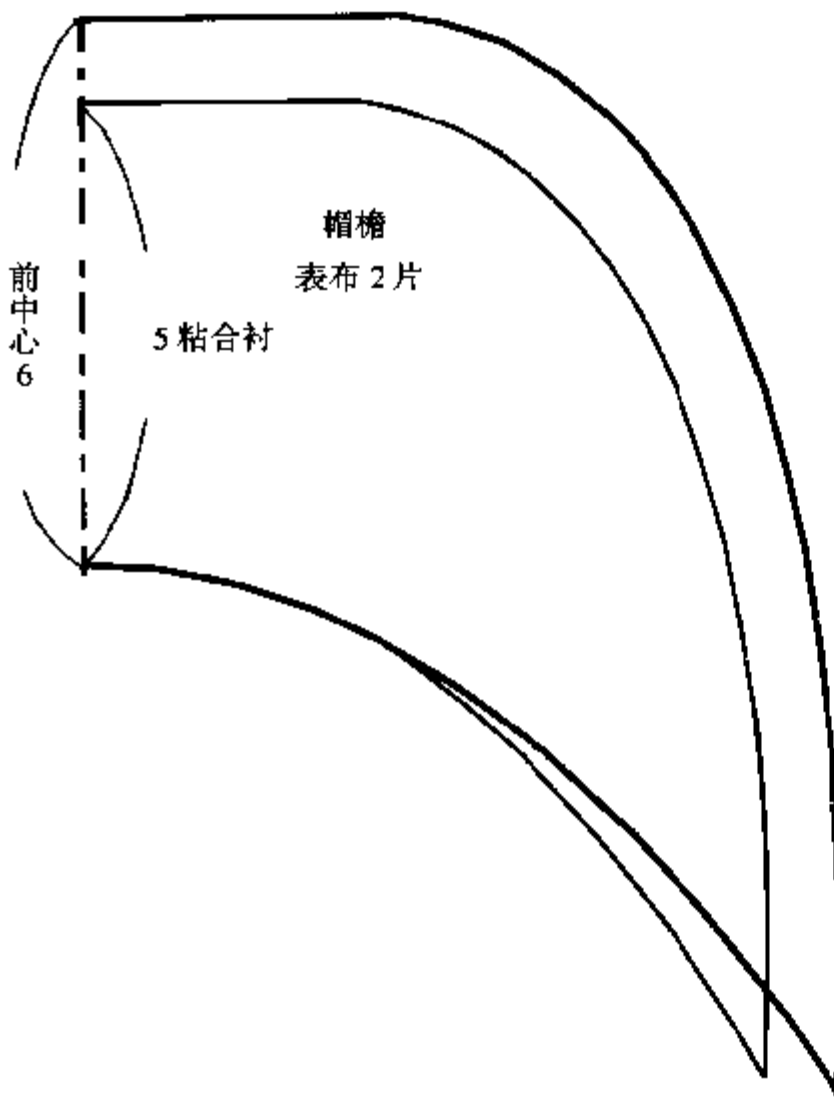
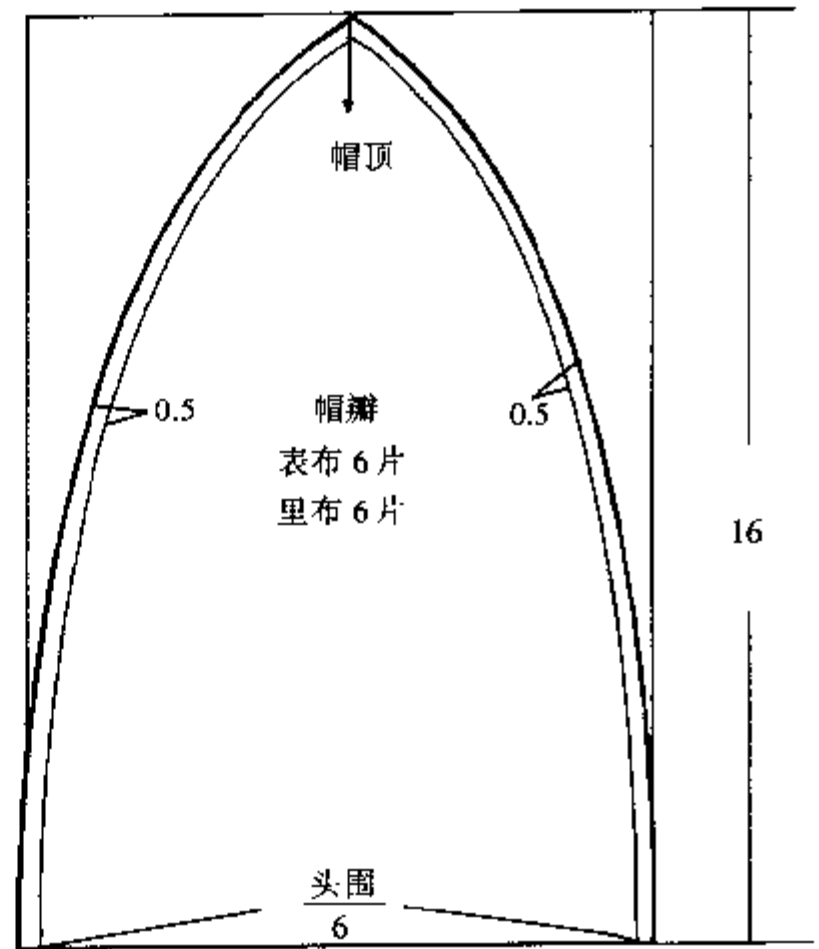

① 在帽檐 0.7cm 处缉明线, 帽口处打剪口



②缝合帽瓣并劈缝熨烫

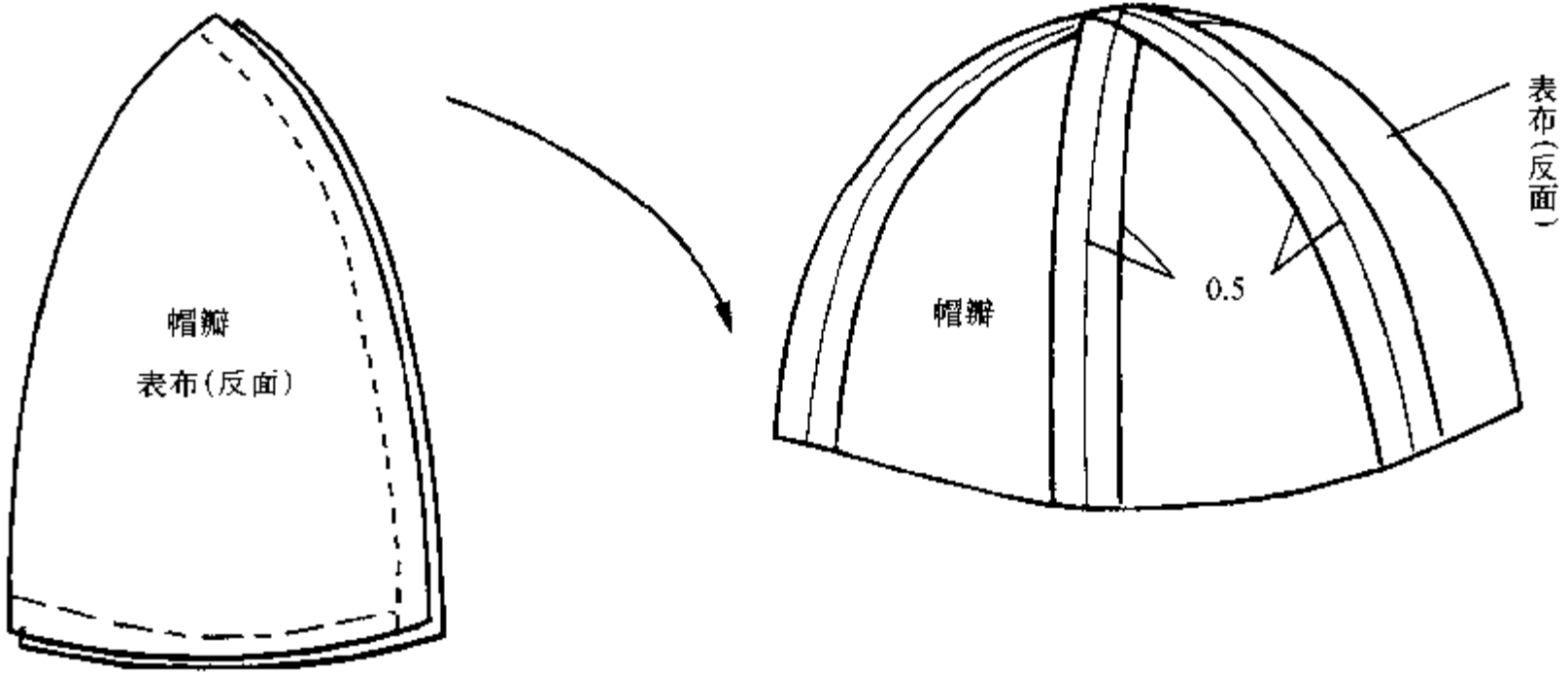

③缝合里布并劈缝熨烫

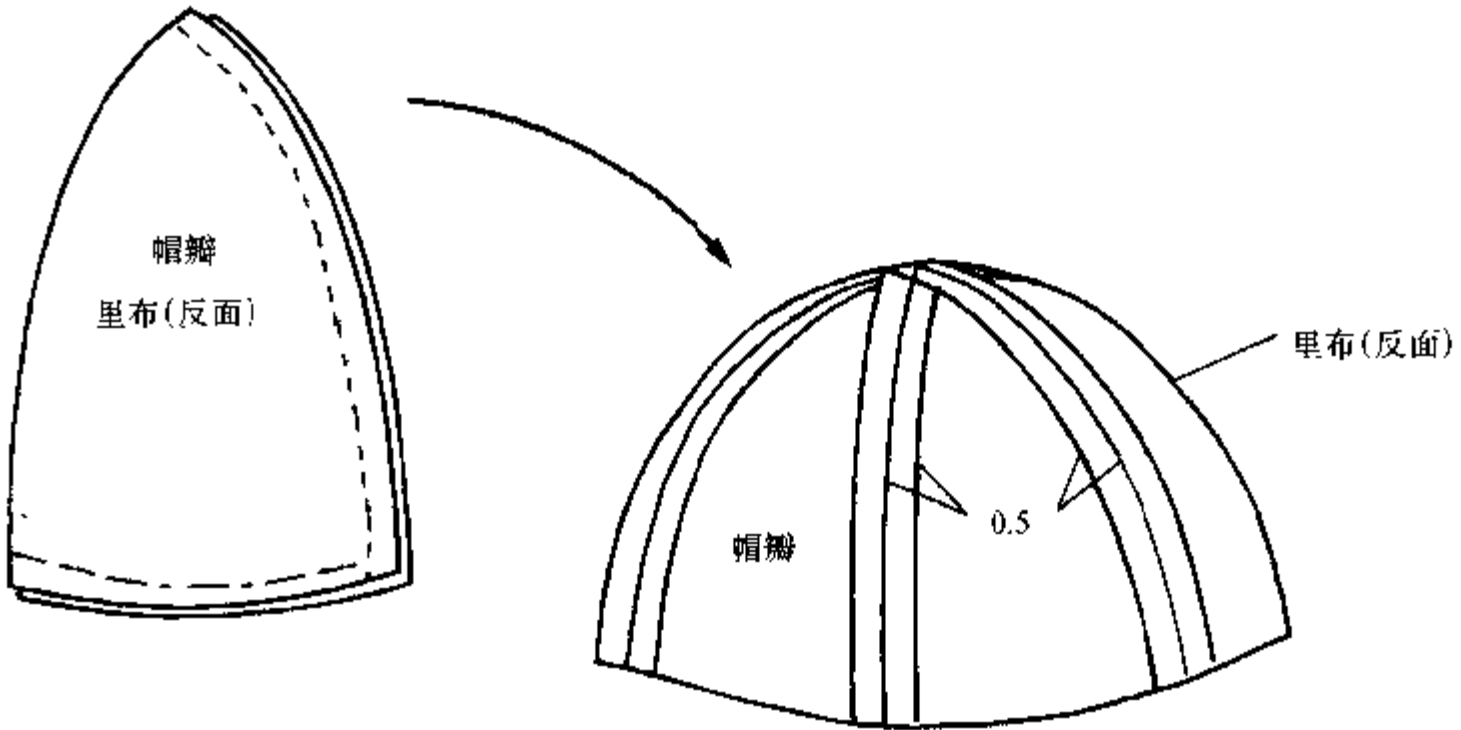

④将帽子表、里布反面相对套在一起

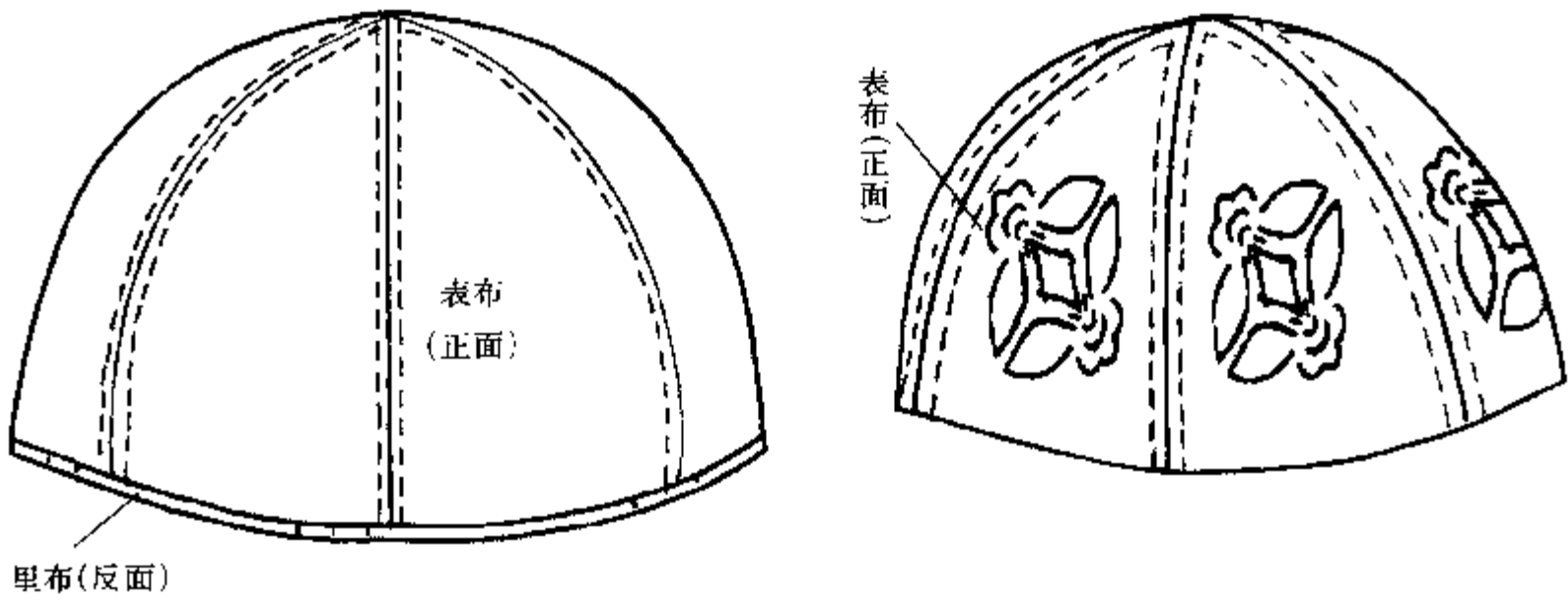

⑥夹缝帽檐

⑤缝合汗口条

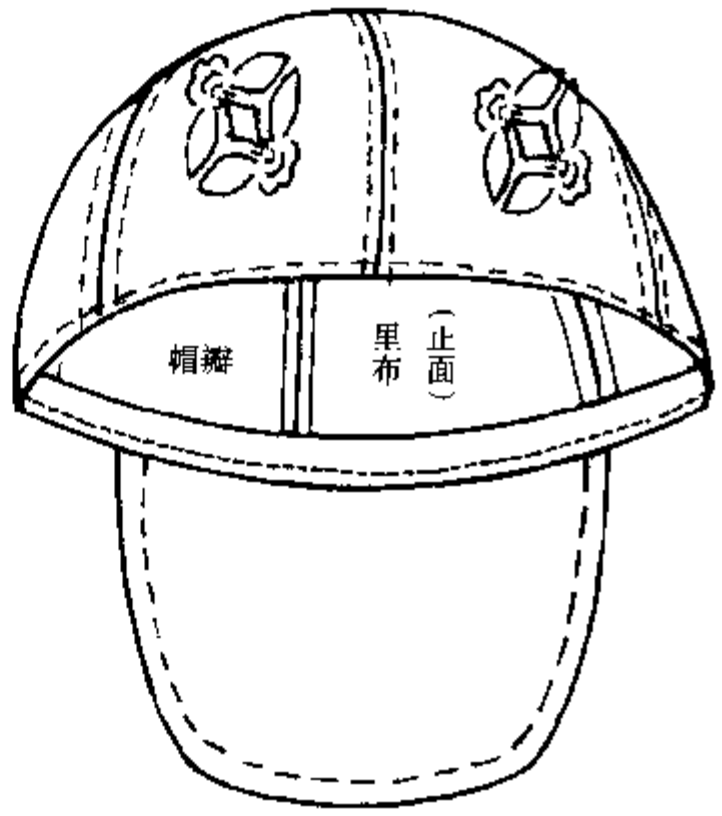
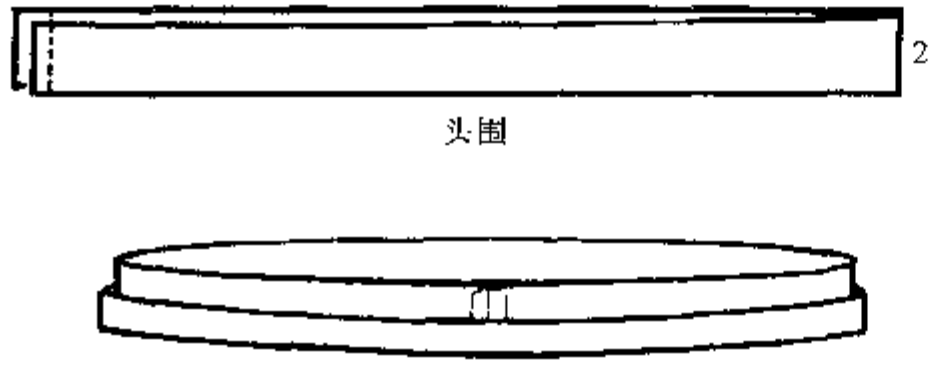

⑦用棉花包好扣子钉于帽顶上

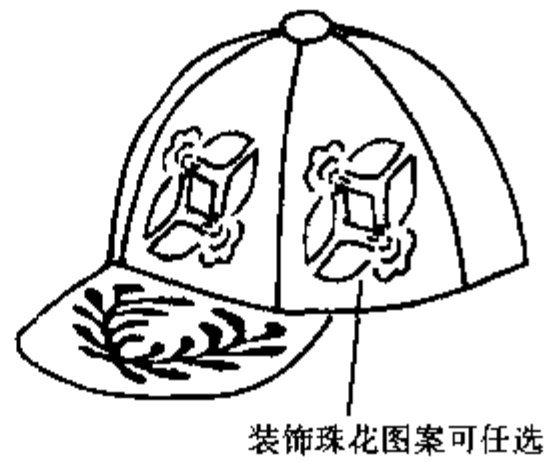
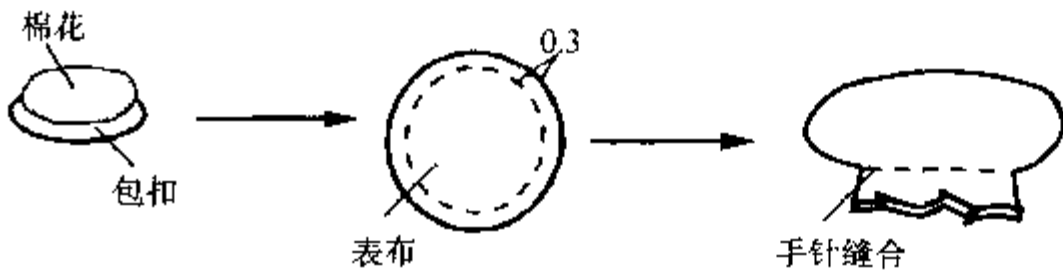

● 典雅女士帽

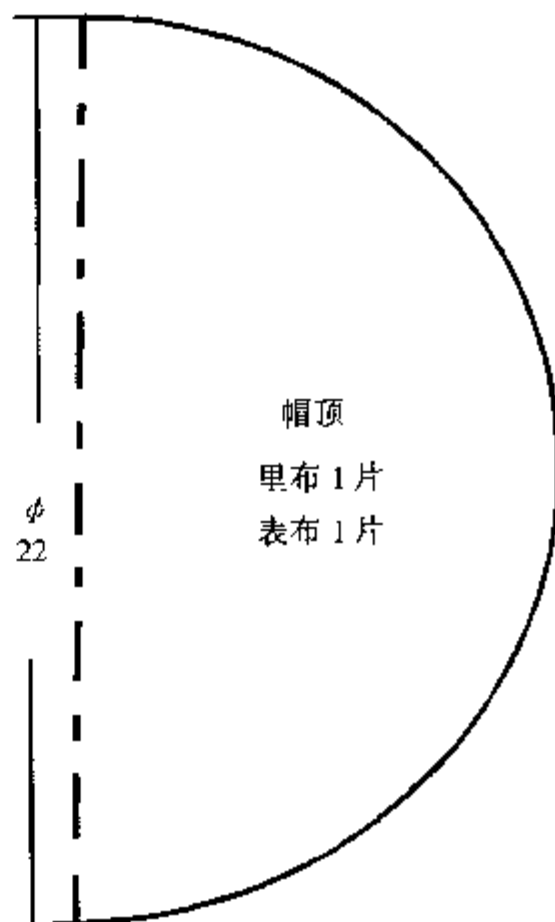

① 缝合帽墙

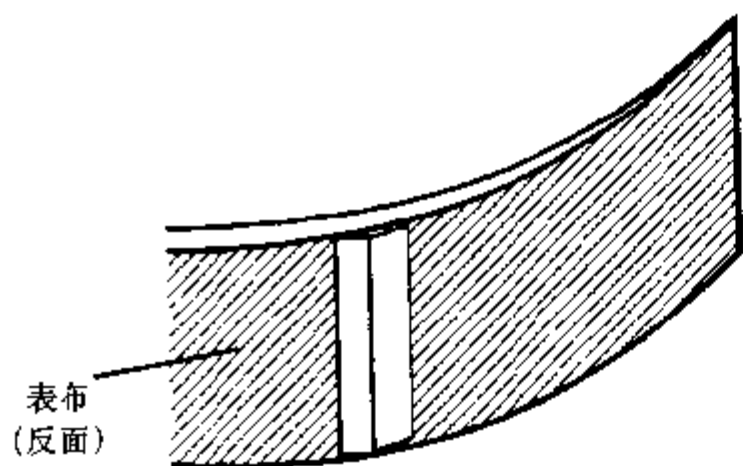
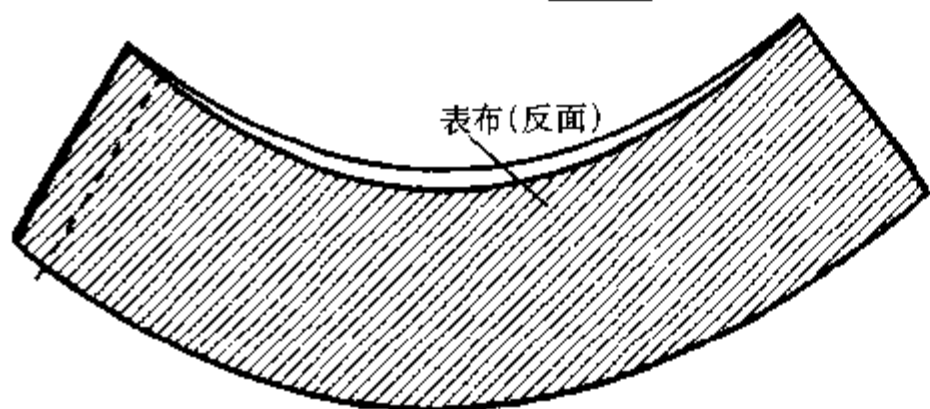

② 缝合帽墙表、里布

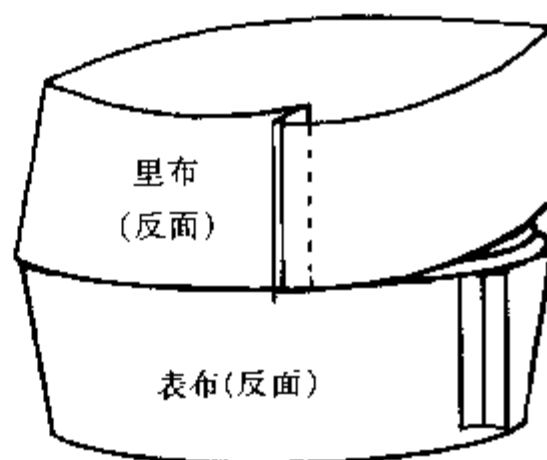

③缝合帽顶

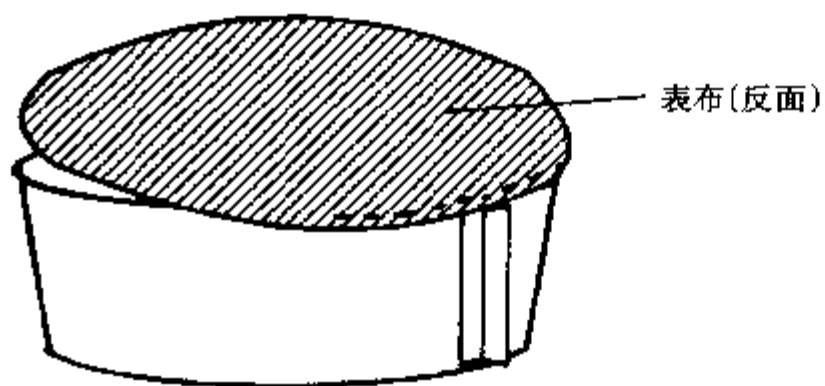

④缝合汗口条

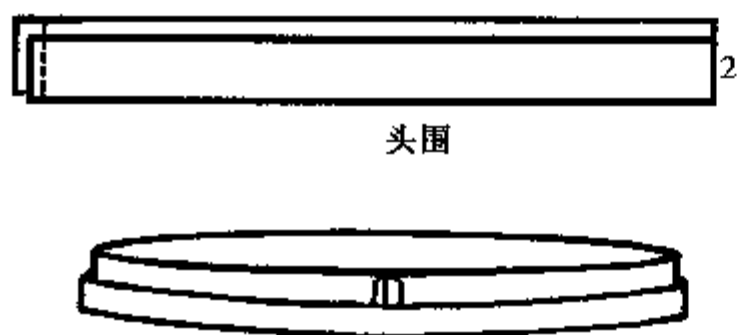

⑤缝合帽墙与帽顶

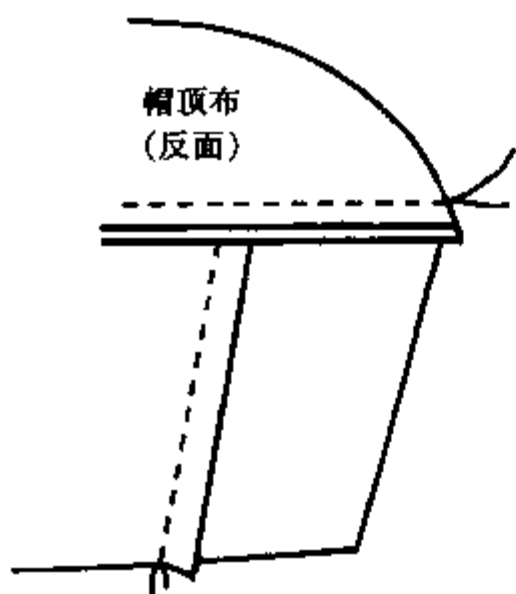

⑥劈缝并熨烫

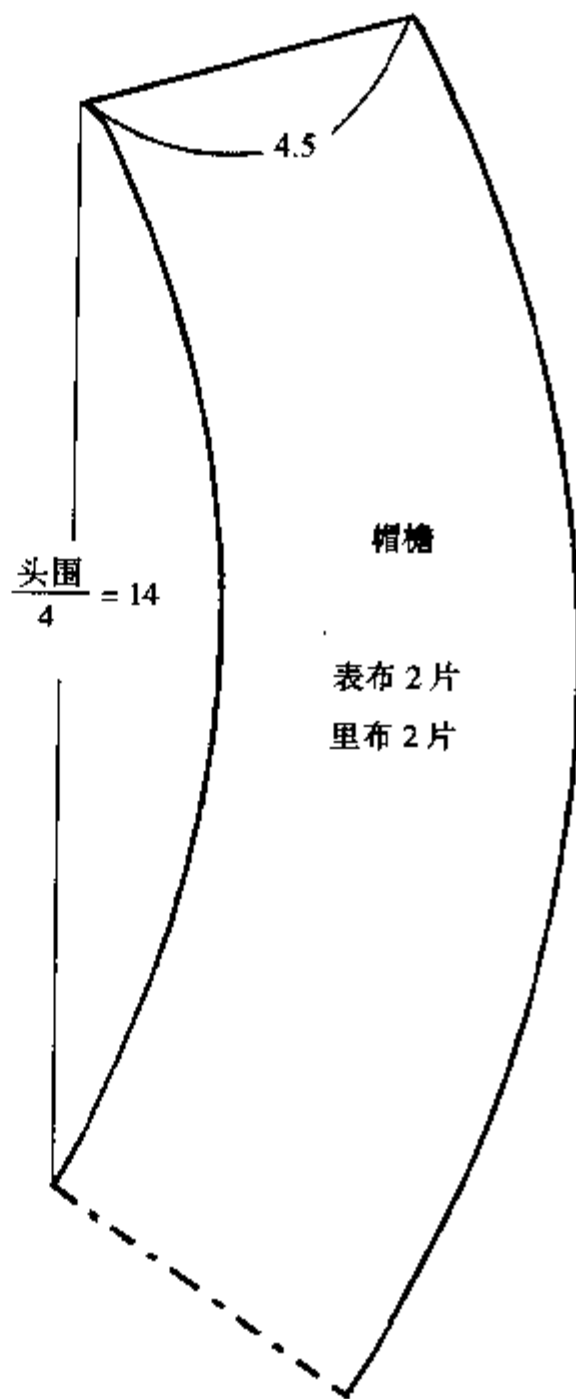
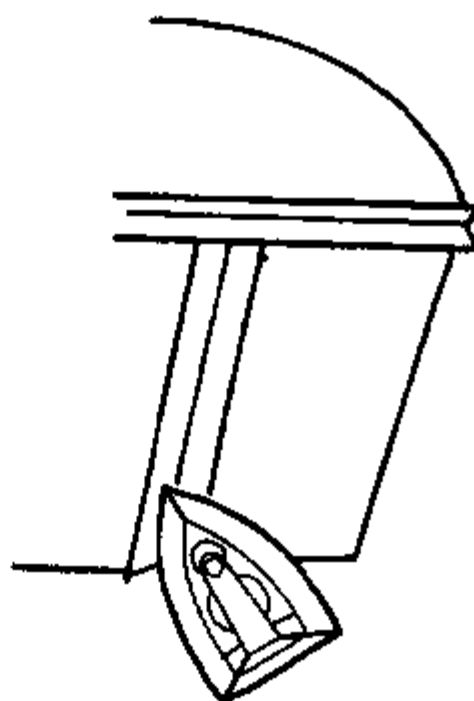



● 八棱圆形帽

① 帽顶裁片加缝份

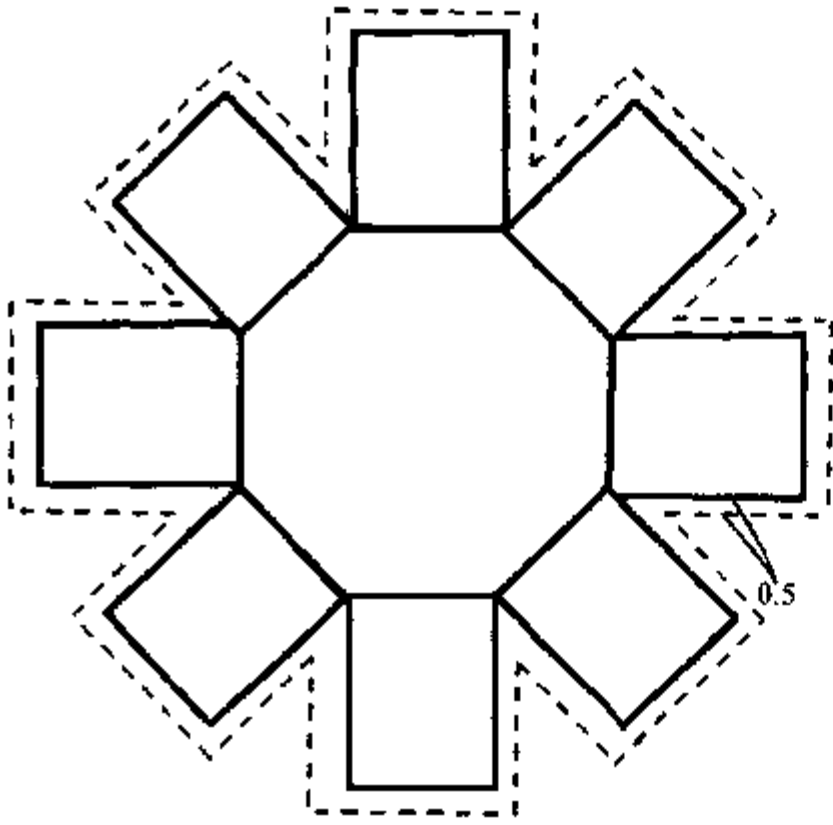

② 缝合八棱并劈缝

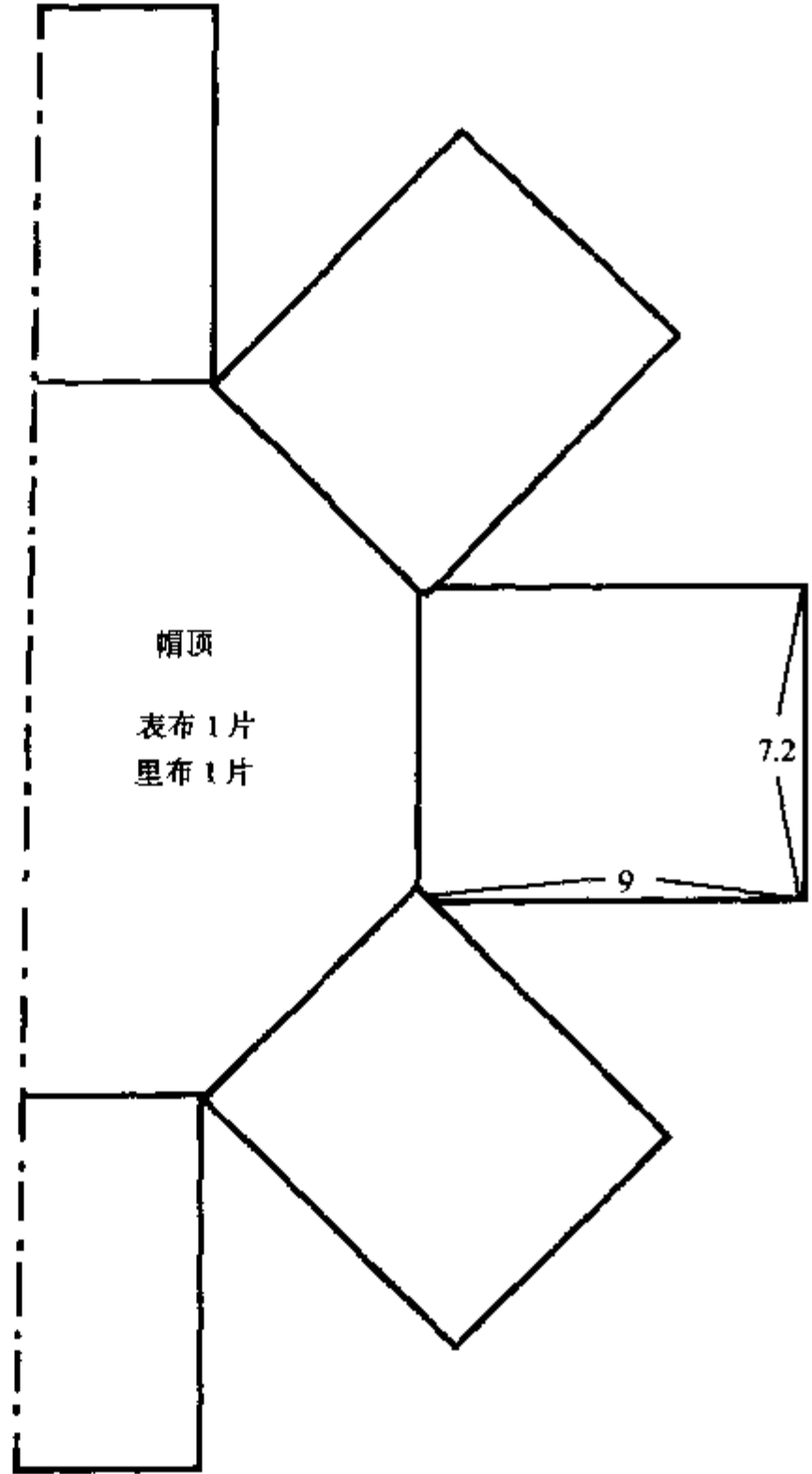
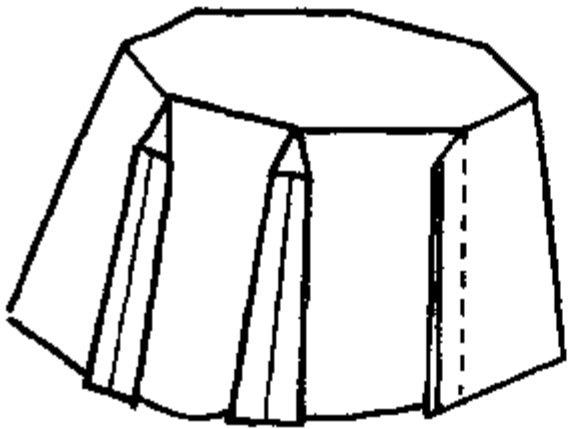

③缝合帽檐

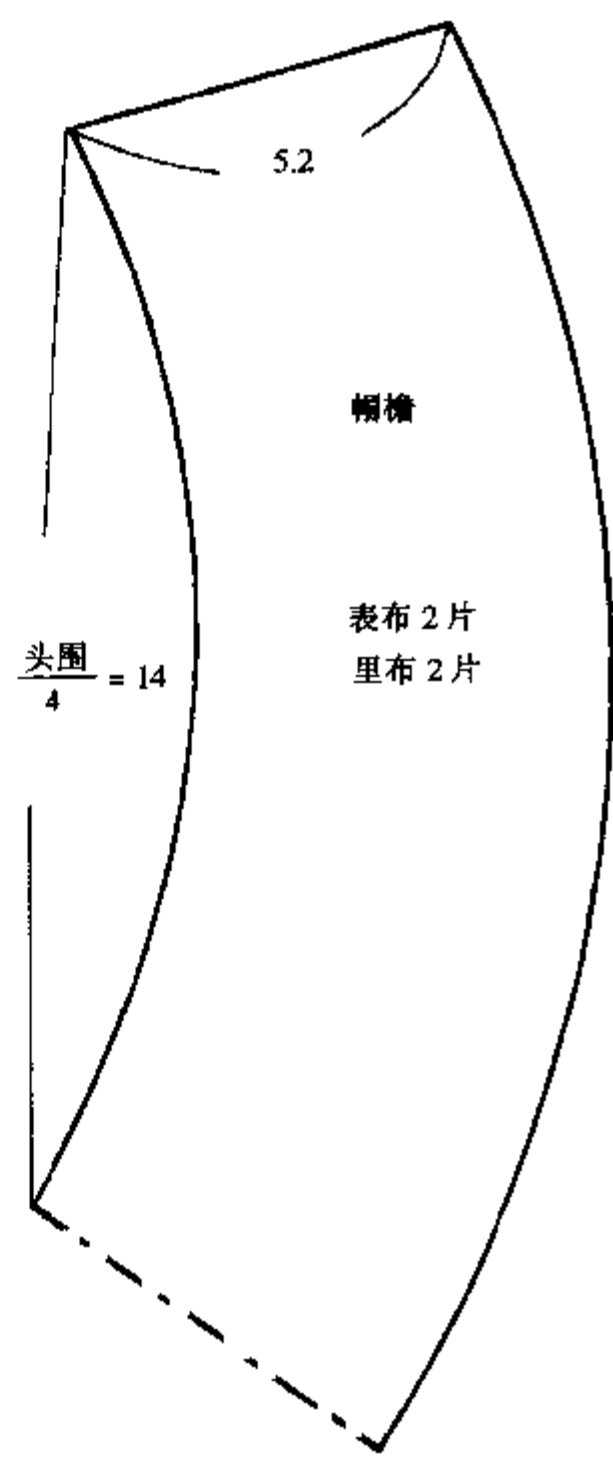
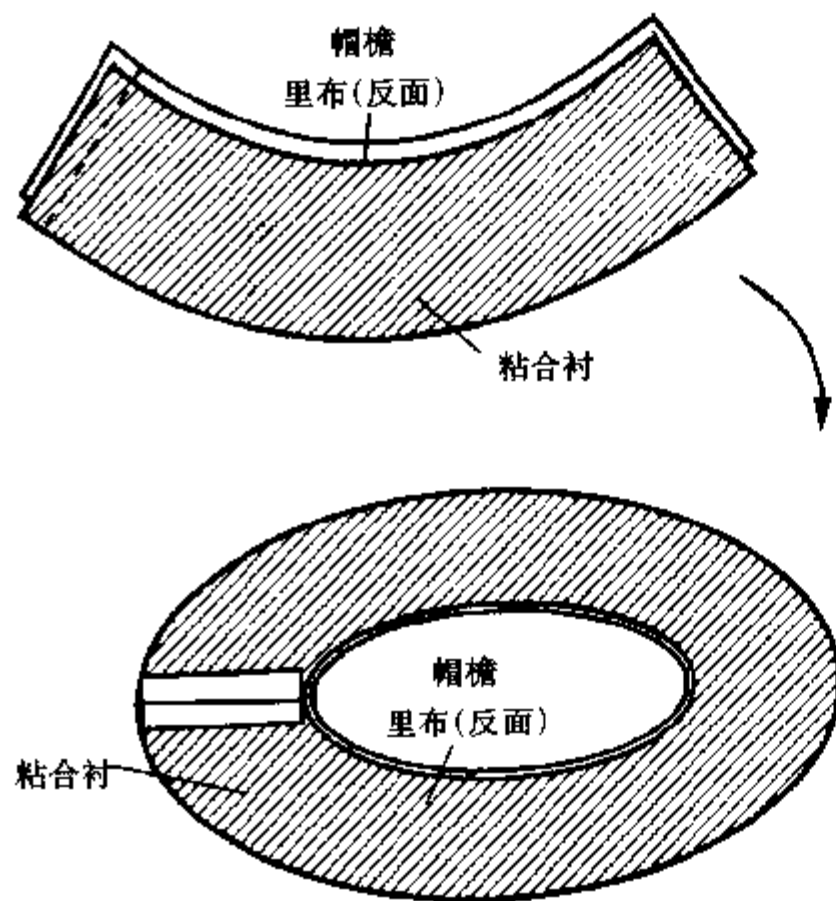

④在帽檐 1cm 处缉明线, 帽口处打剪口

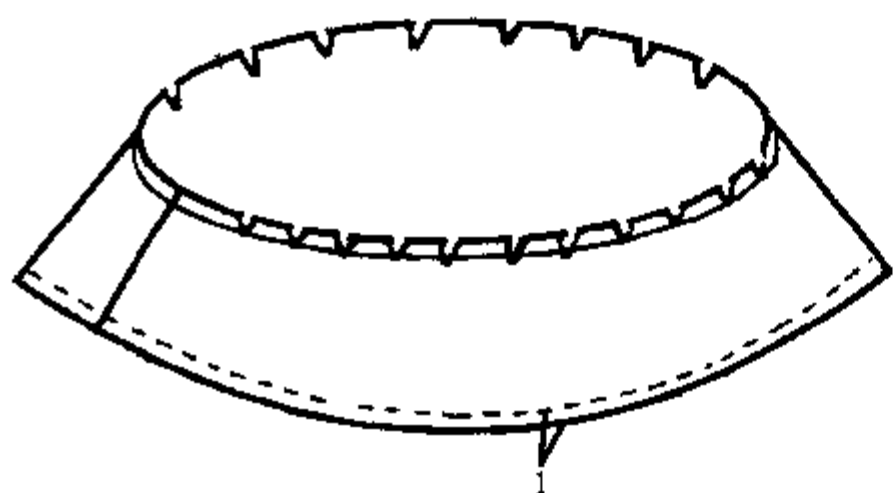

⑤缝合汗口条

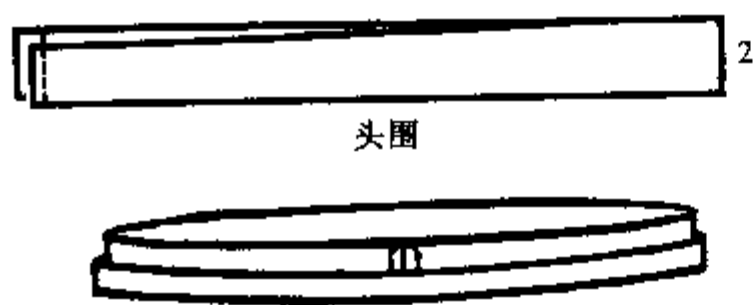

⑥夹缝帽檐

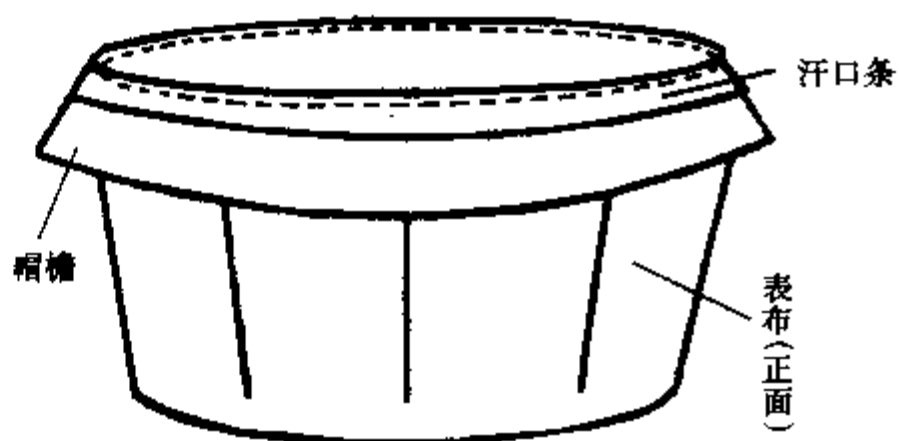



● 圓頂六片連檐帽

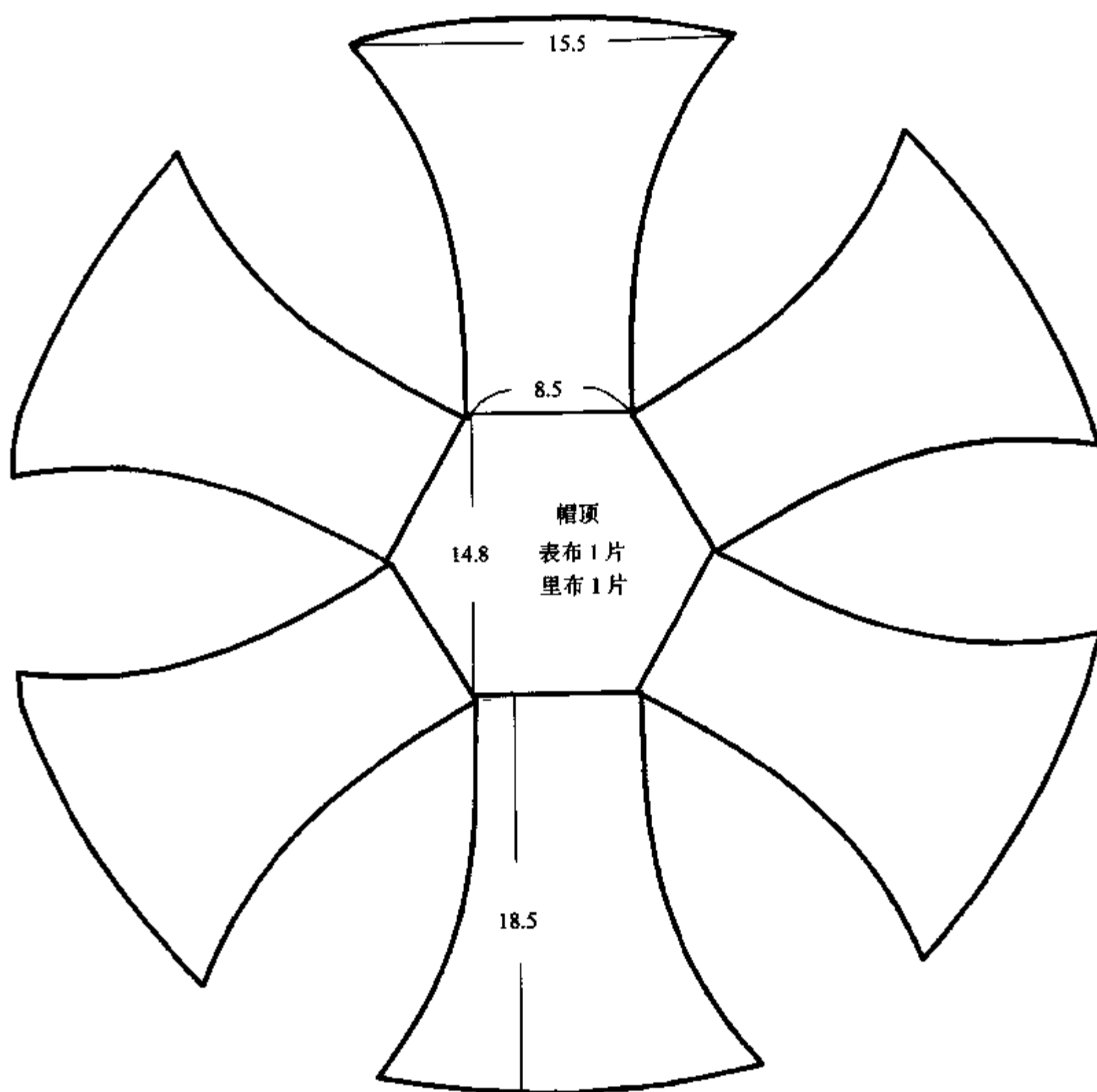

①帽瓣加缝份

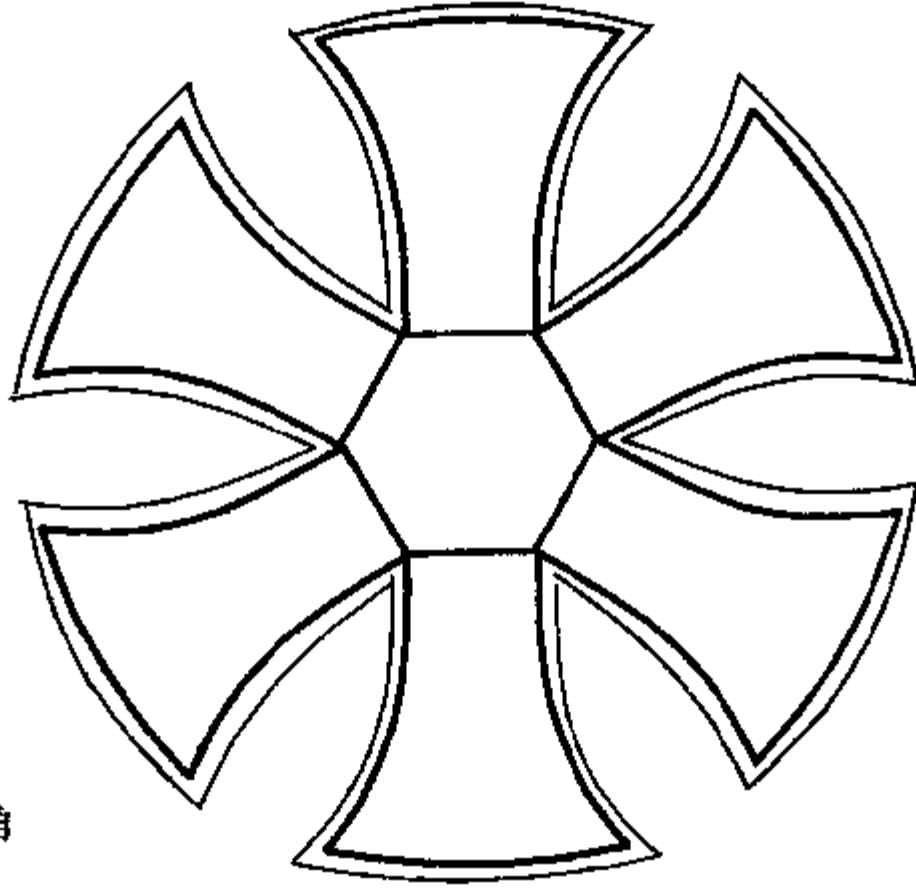

②缝合六角

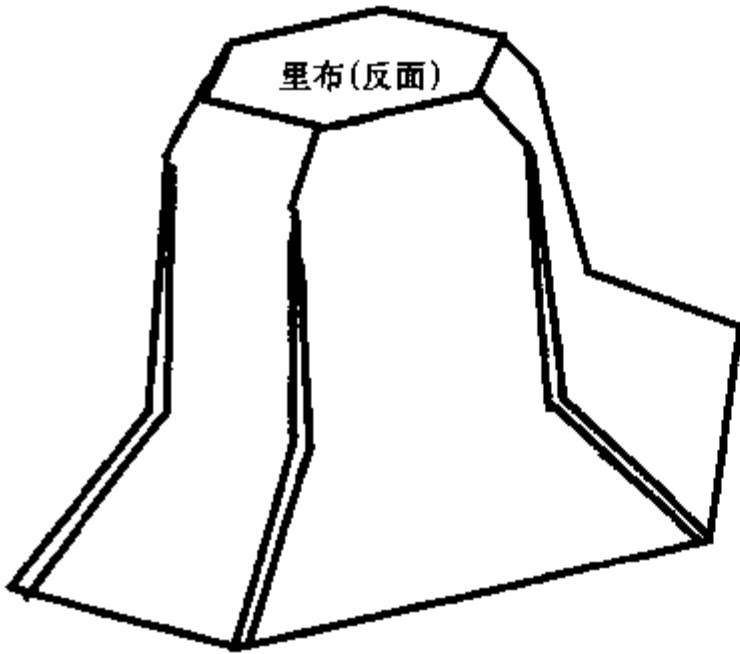

③劈缝并熨烫

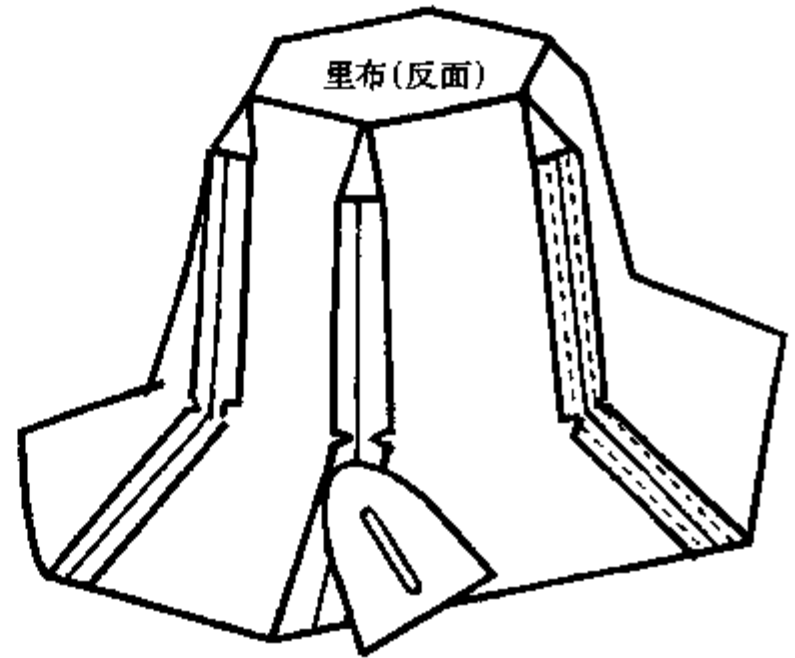

④缉明线

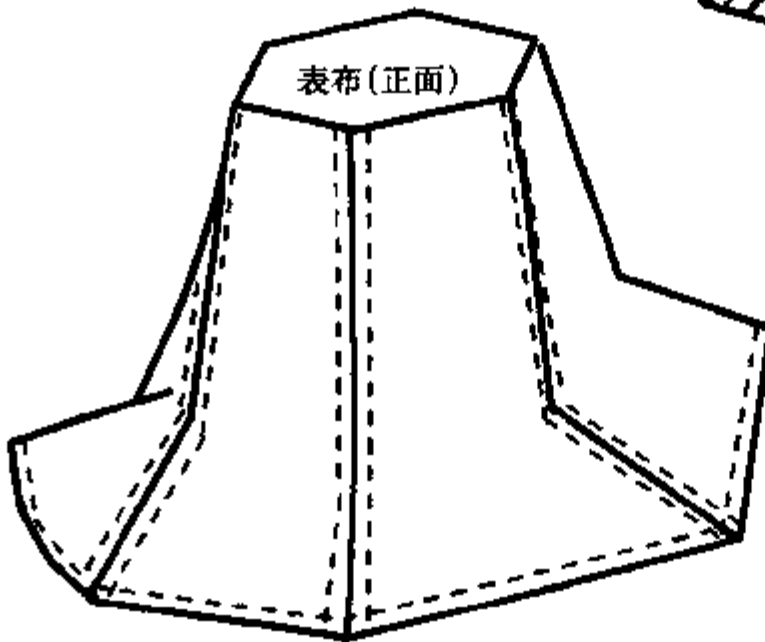

● 休闲旅游遮阳帽

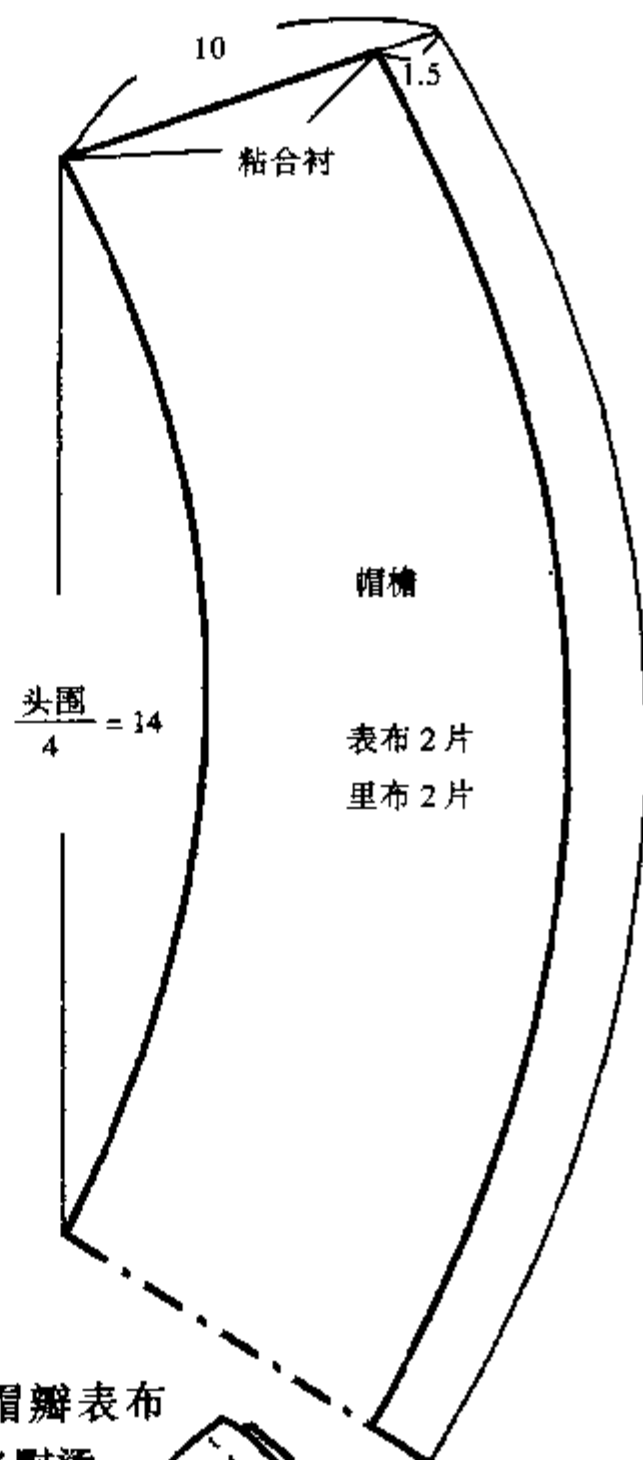
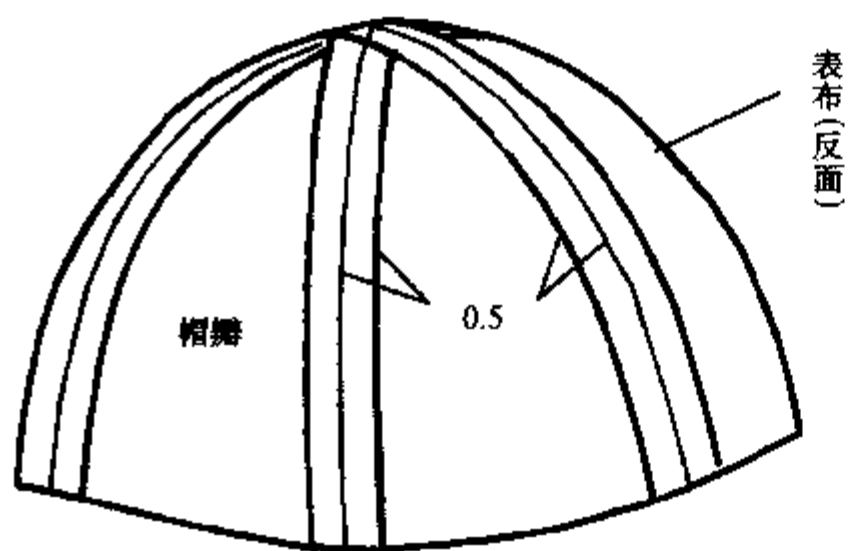
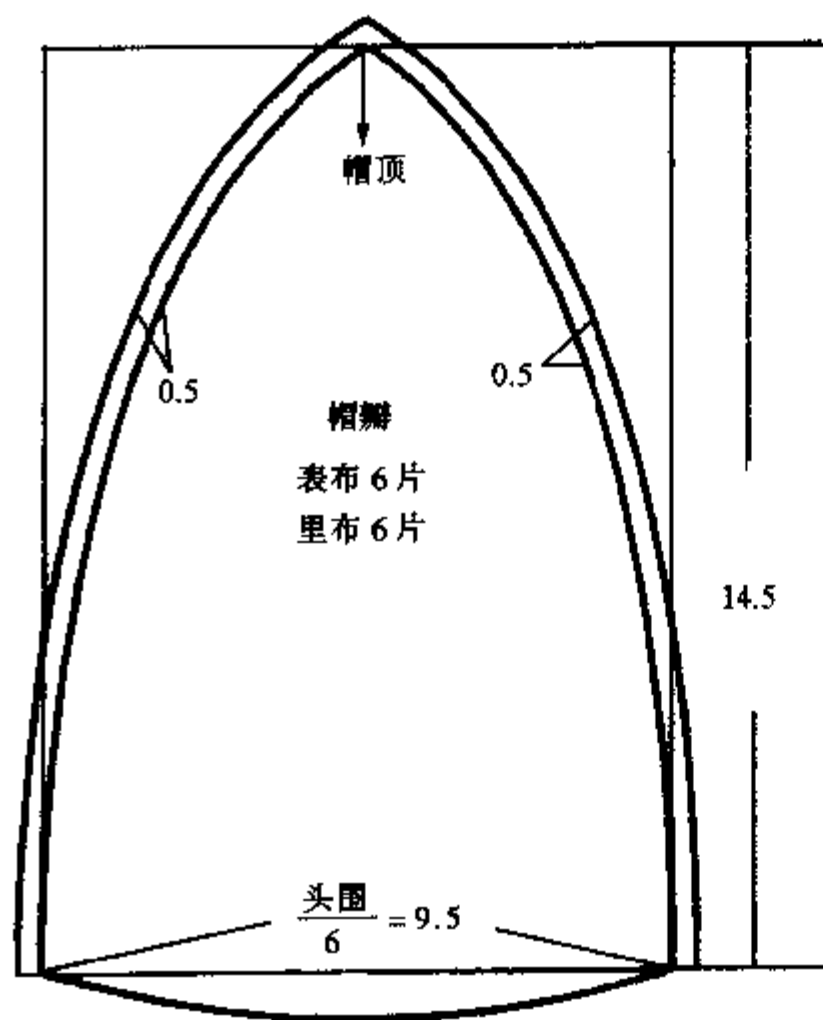
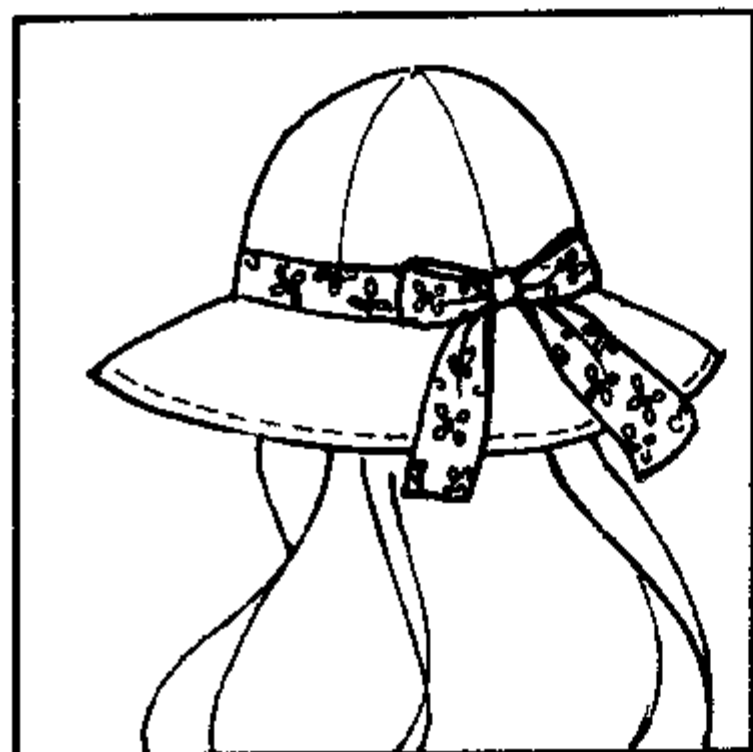

① 缝合帽瓣表布
并劈缝熨烫

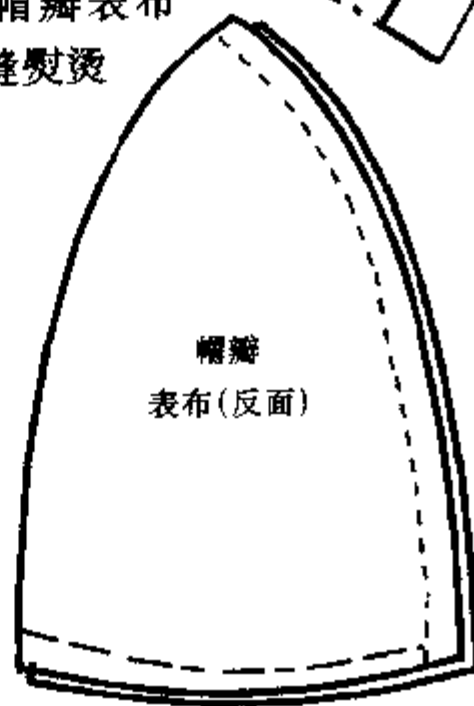

②缝合帽瓣里布并劈缝熨烫

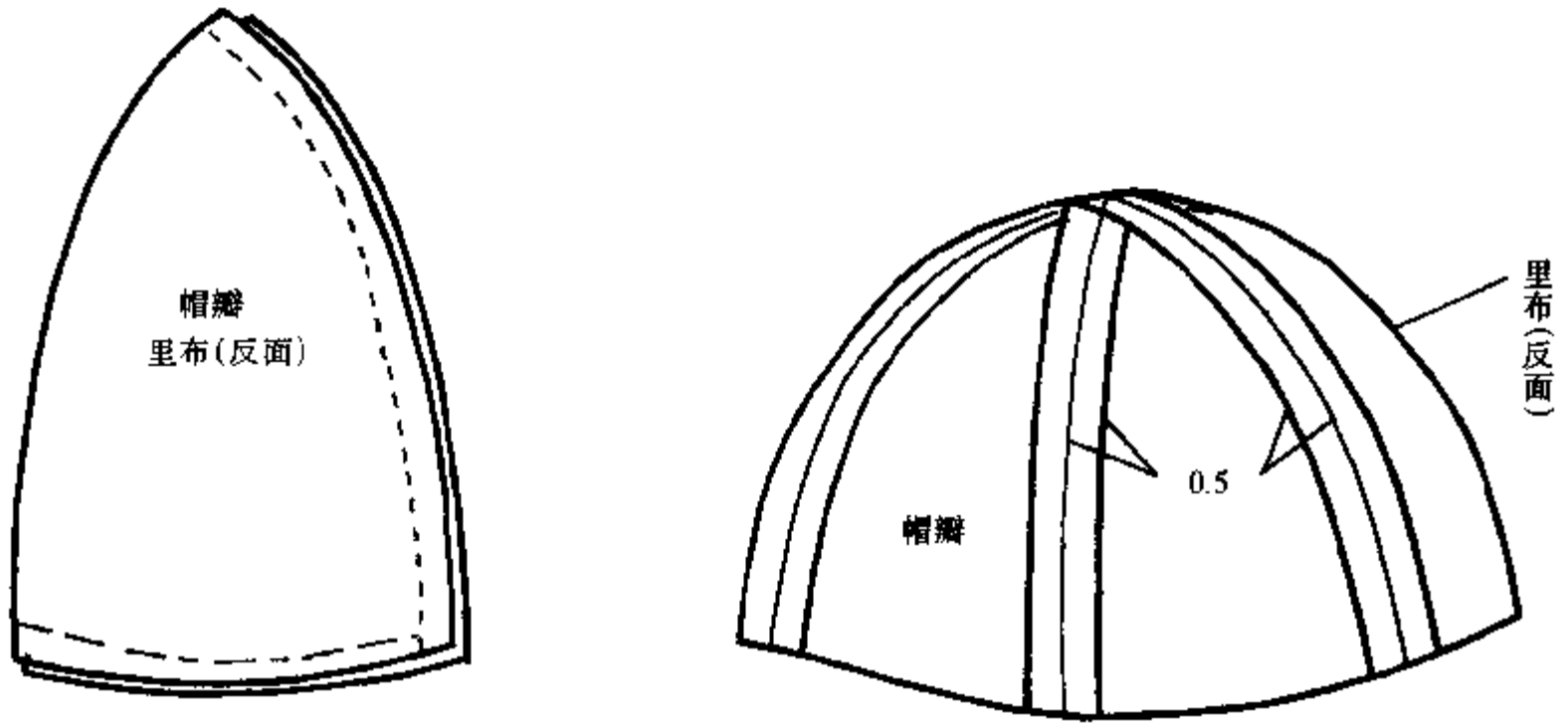

③将帽子表、里布反面相对套在一起

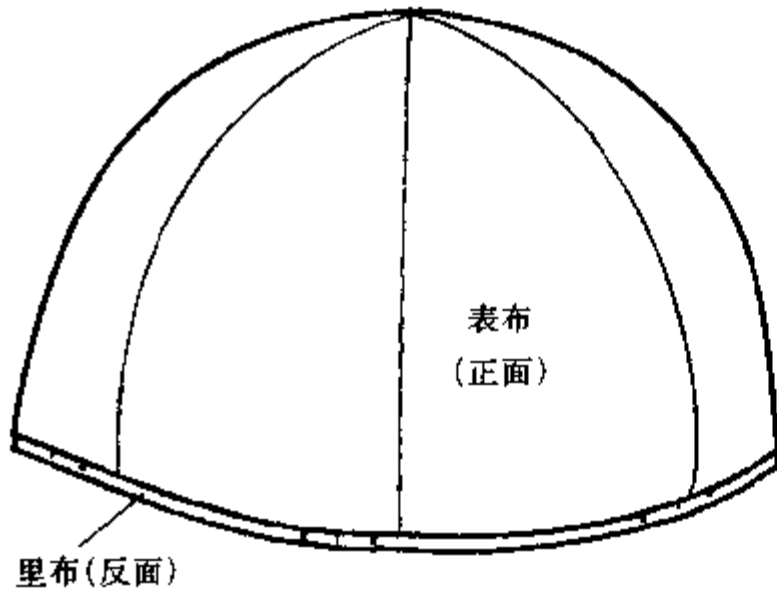

④缝合帽檐

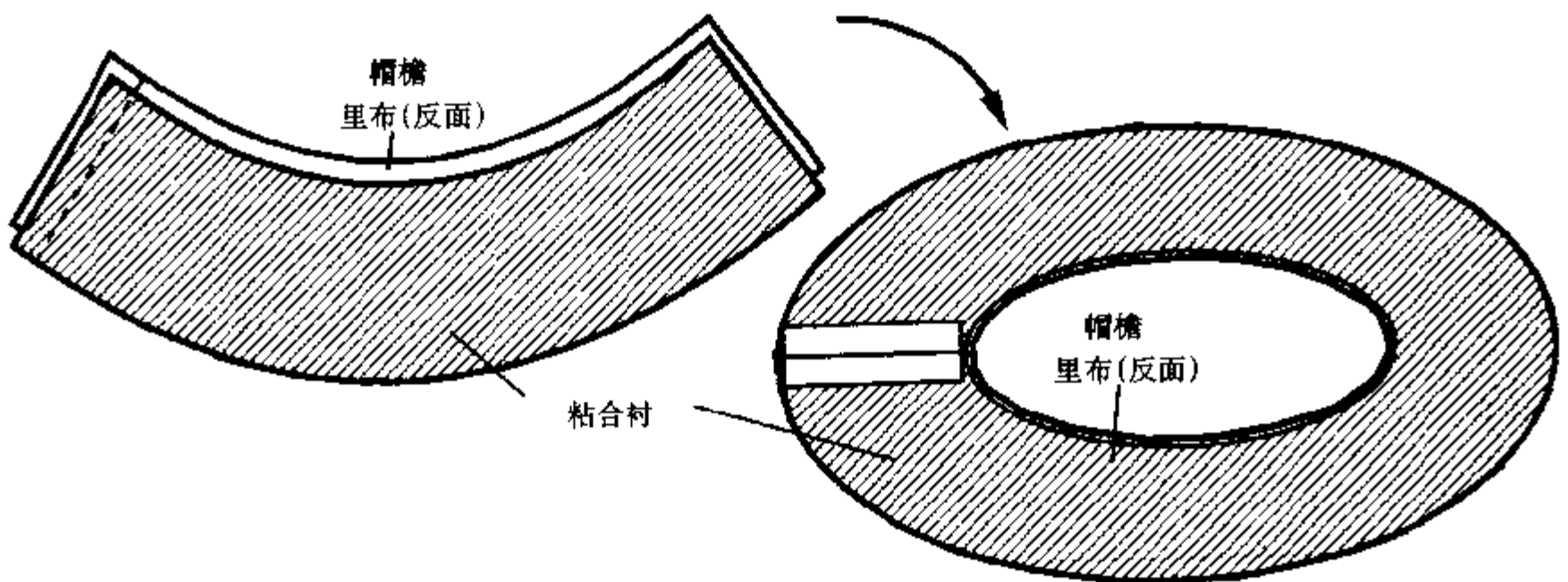

⑤在帽檐 1cm 处缉明线,帽口处打剪口

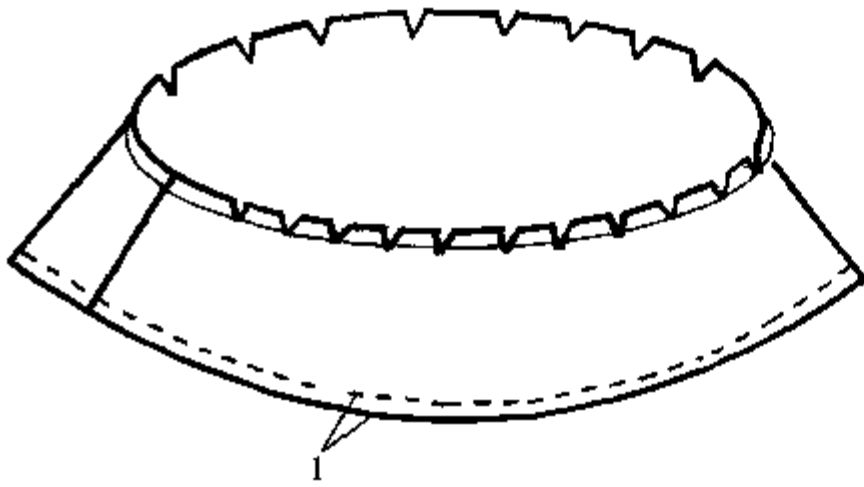

⑥缝合汗口条

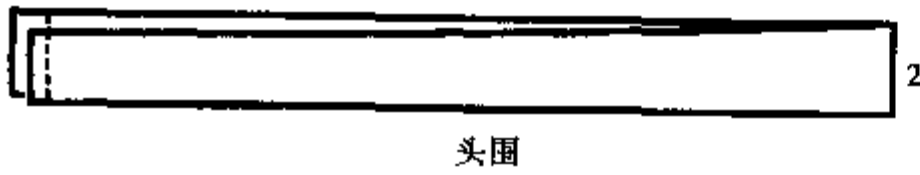

⑦夹缝帽檐

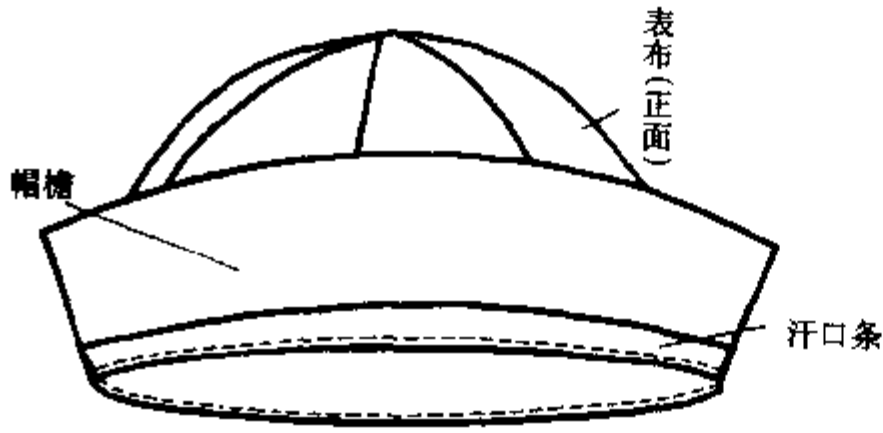

⑧制作帽围小装饰

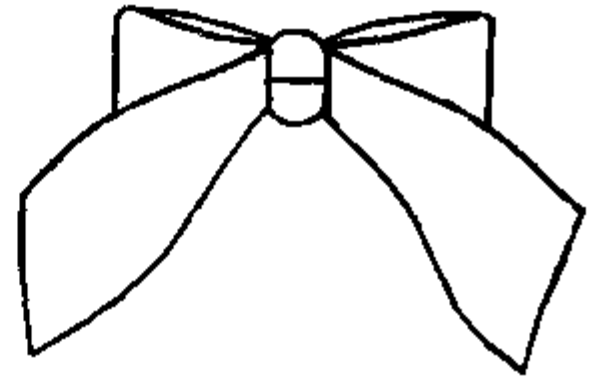
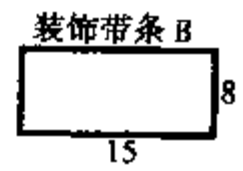
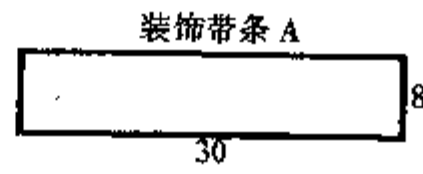
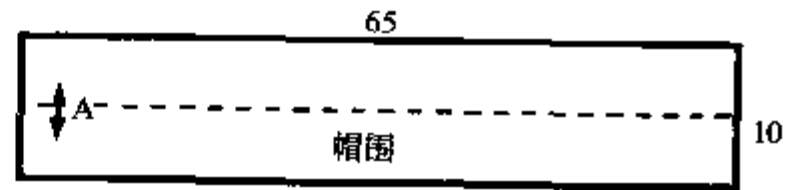

⑨将装饰结缝于帽围上

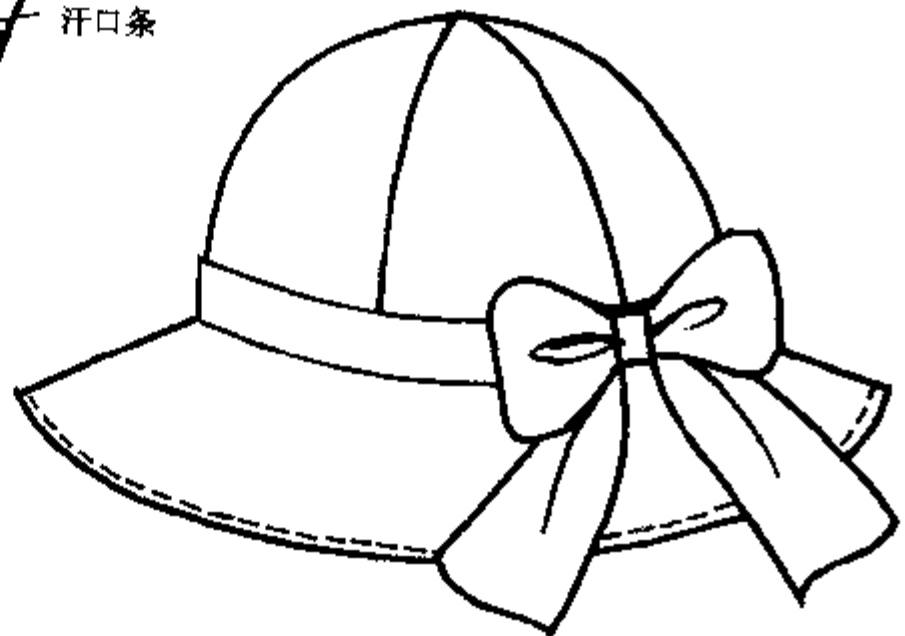

布口袋的制作





●女士挎肩袋

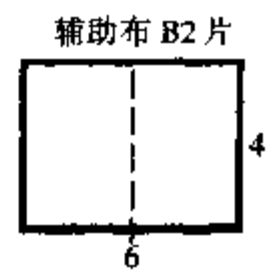
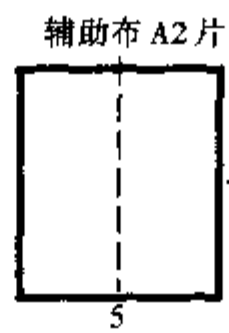
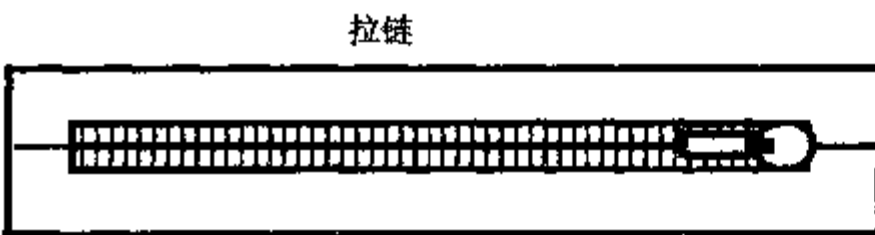
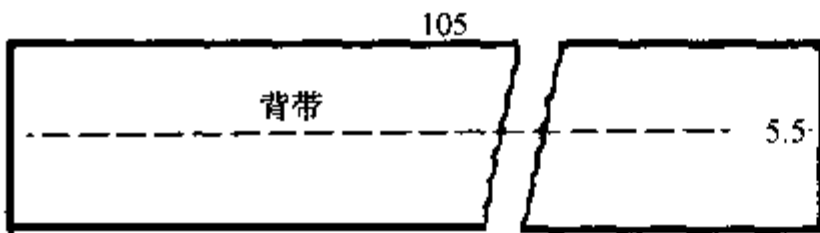
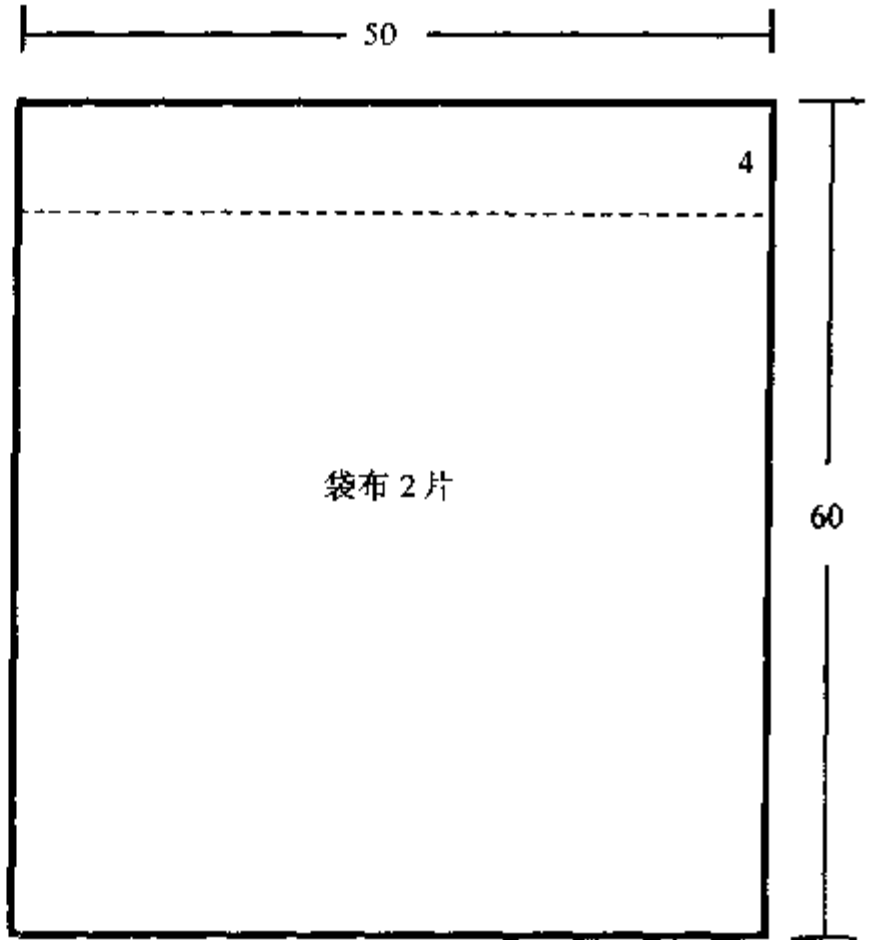

①缝合辅助部件

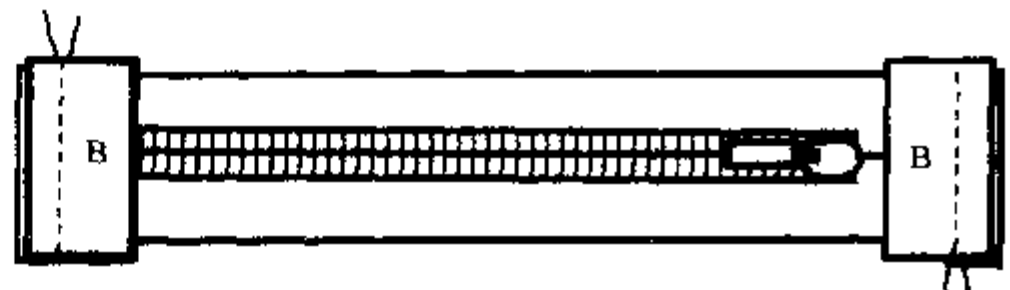
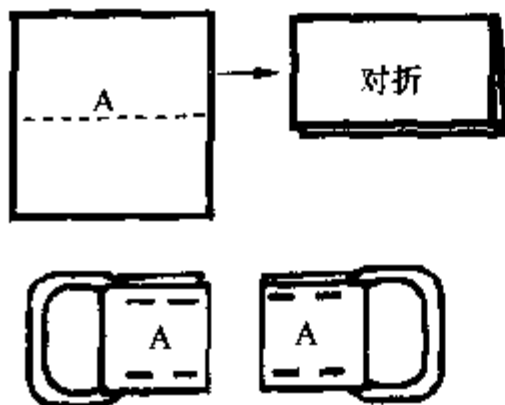

②缝合背带环

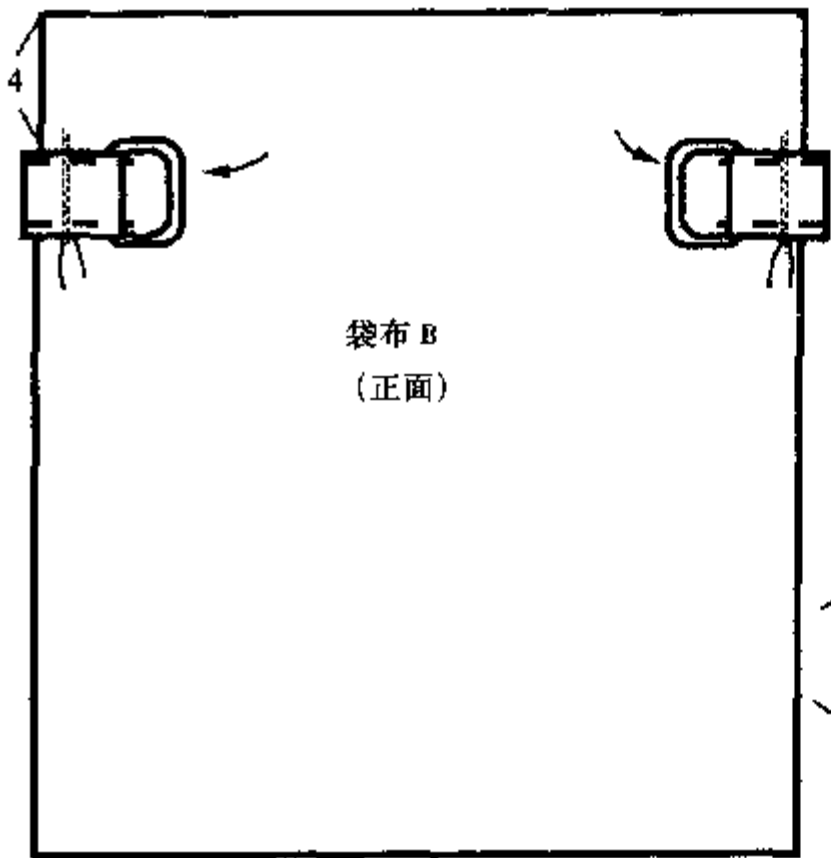

③躺拉链

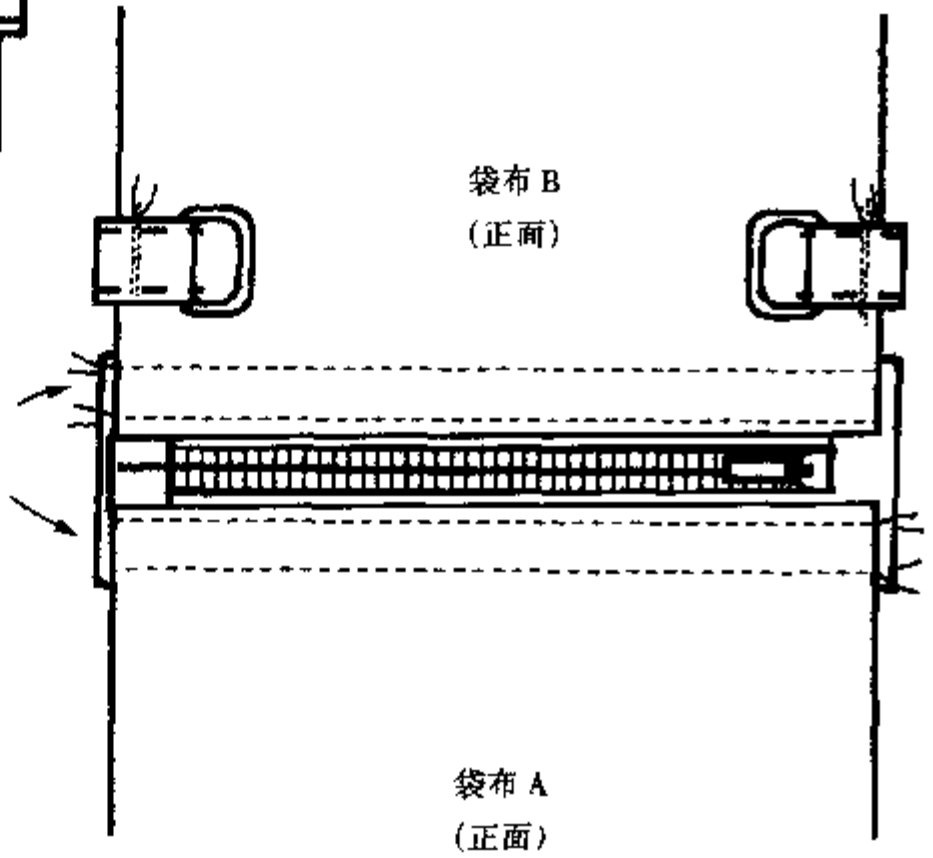

④缝合袋布

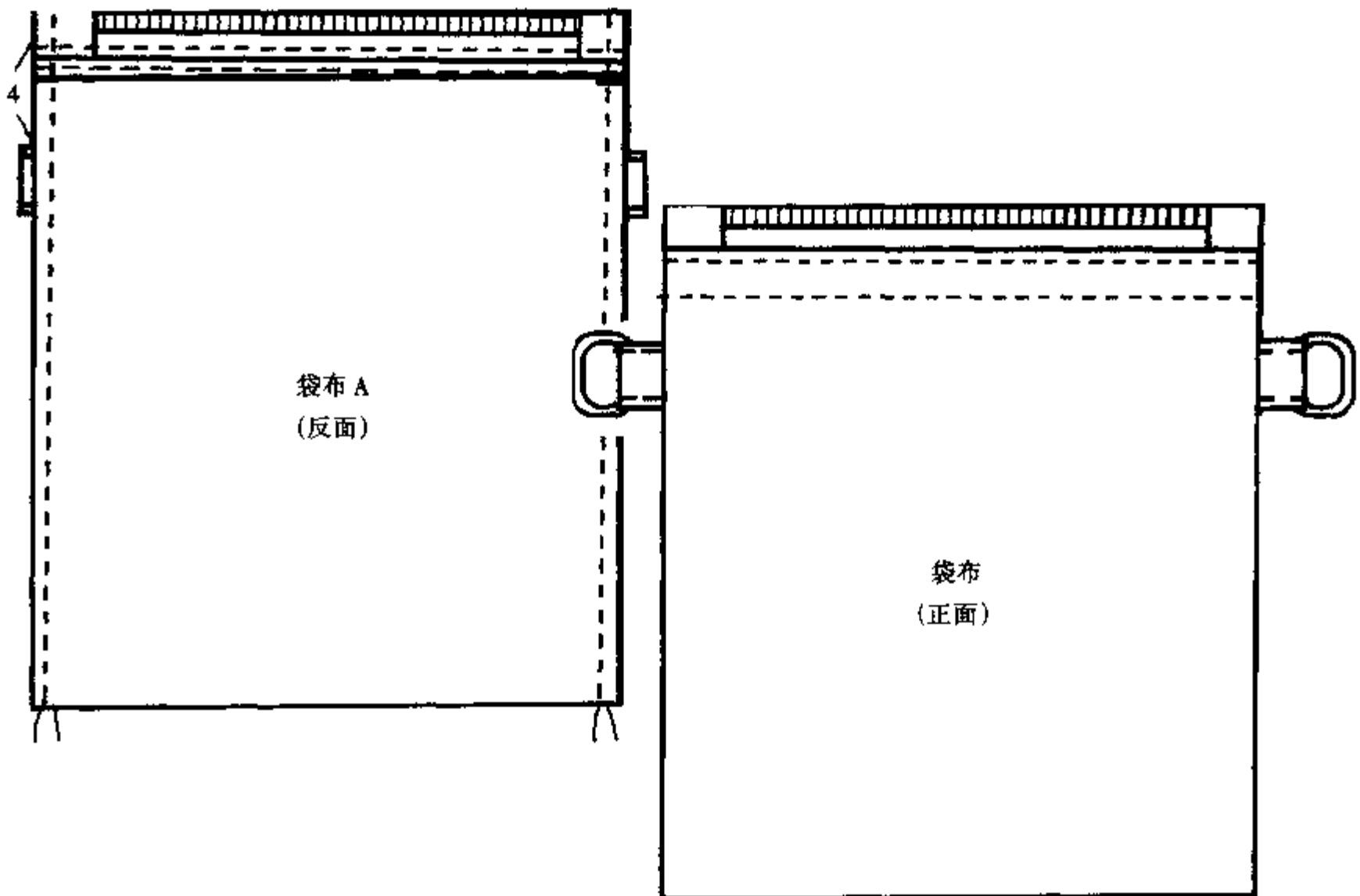

⑤缝合袋布底角

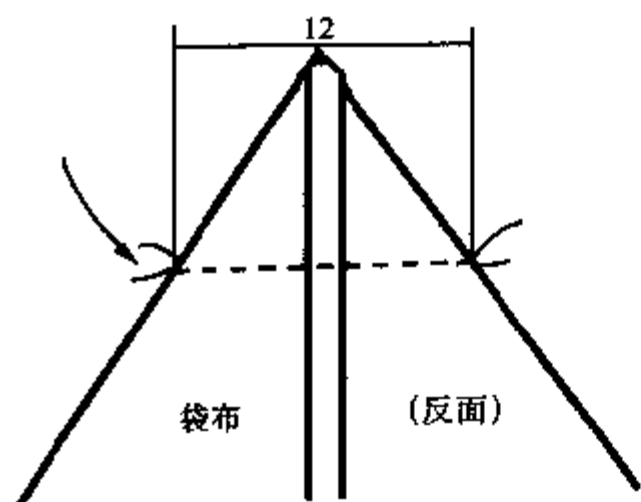

⑥缝合背带

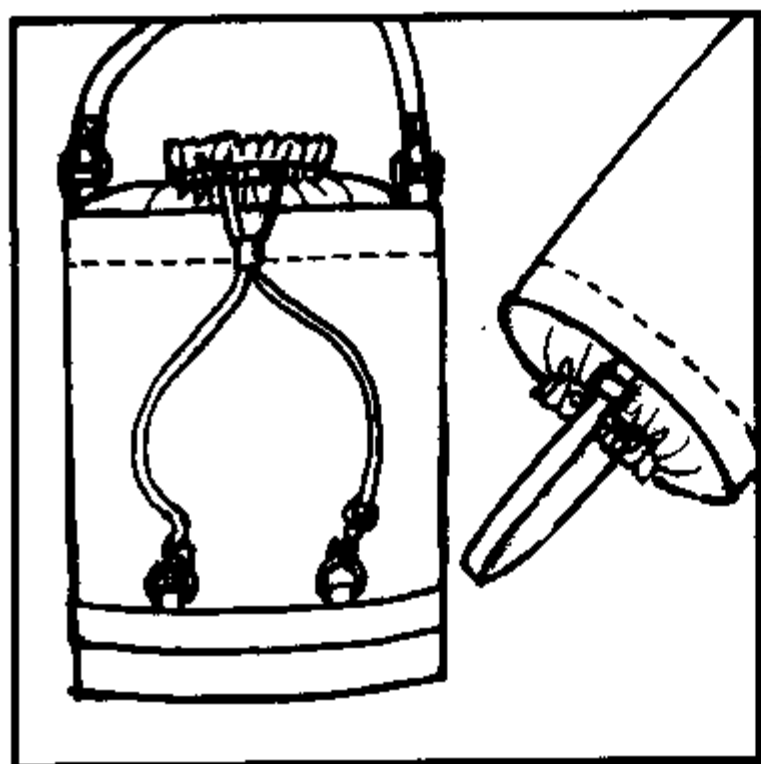
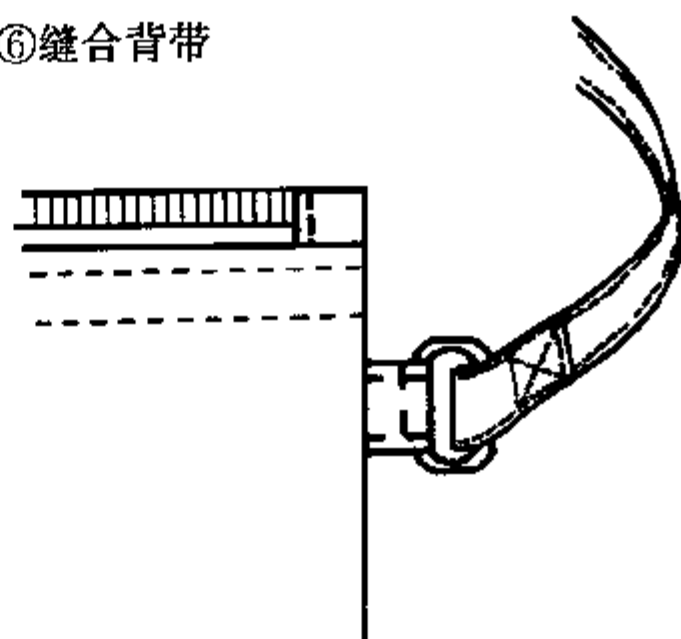

●旅行行李袋

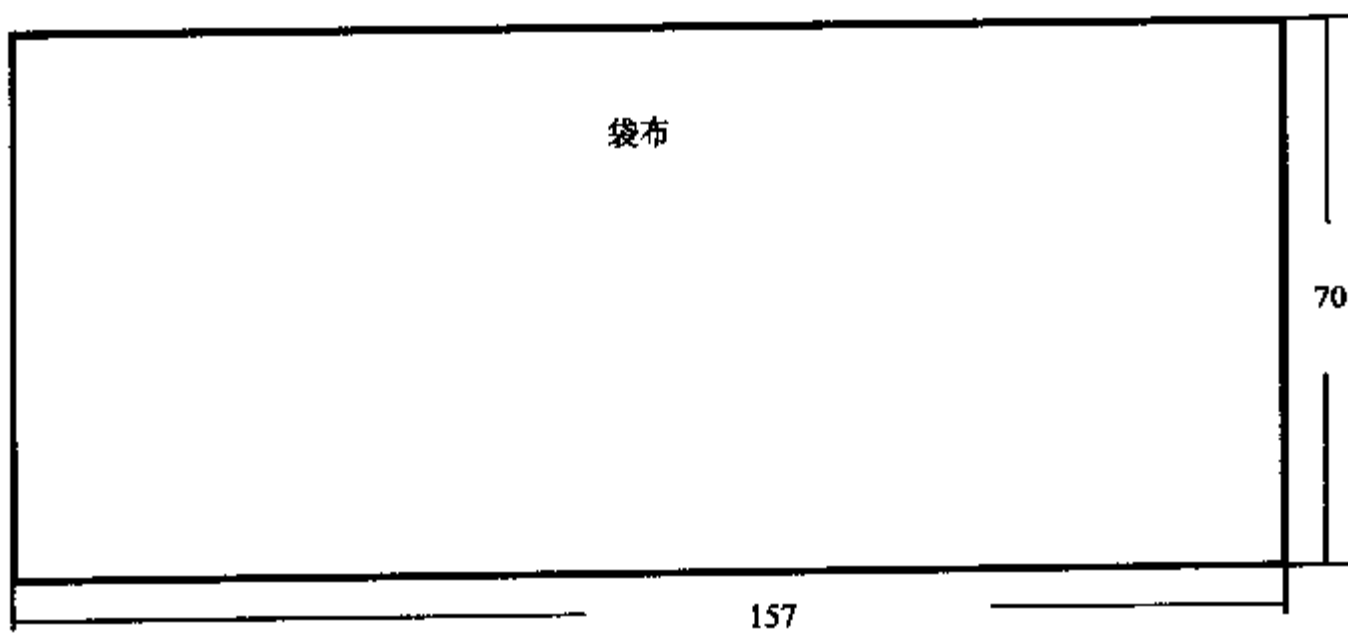
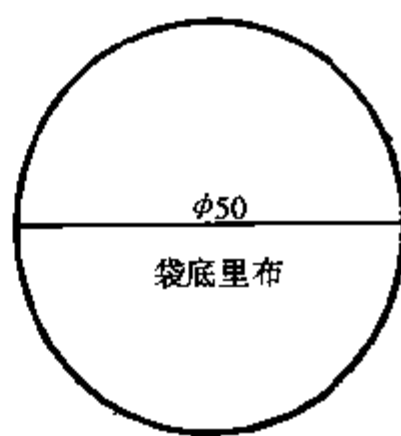
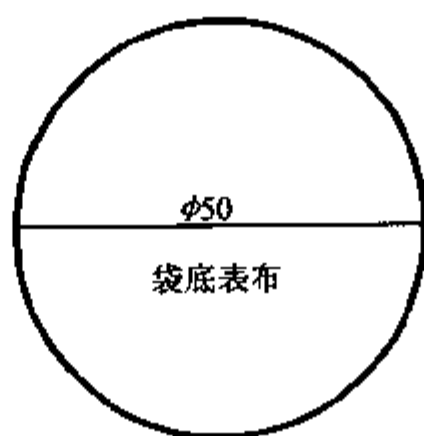

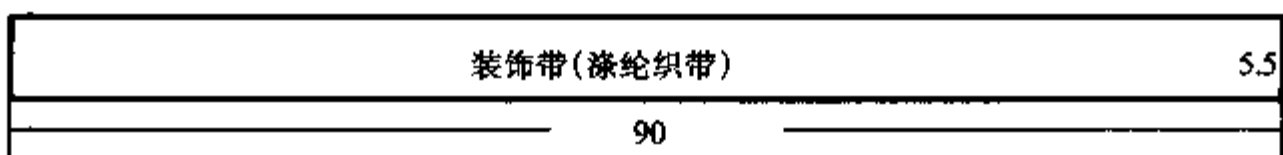
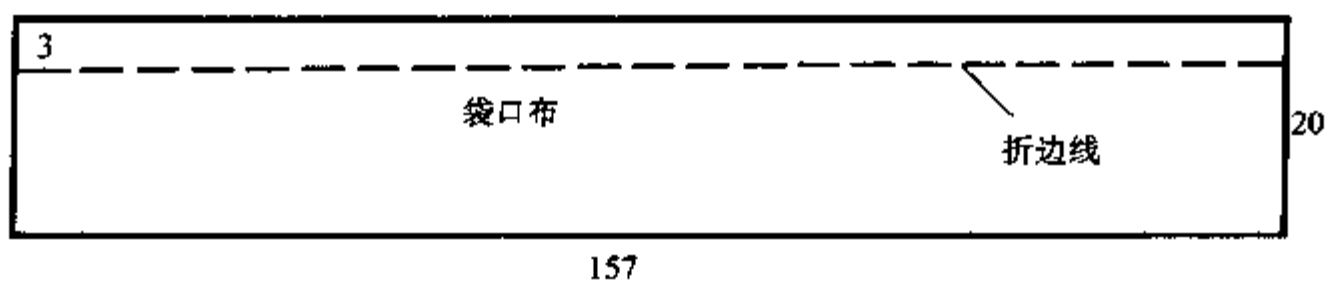

① 缉缝装饰带并夹缝吊环

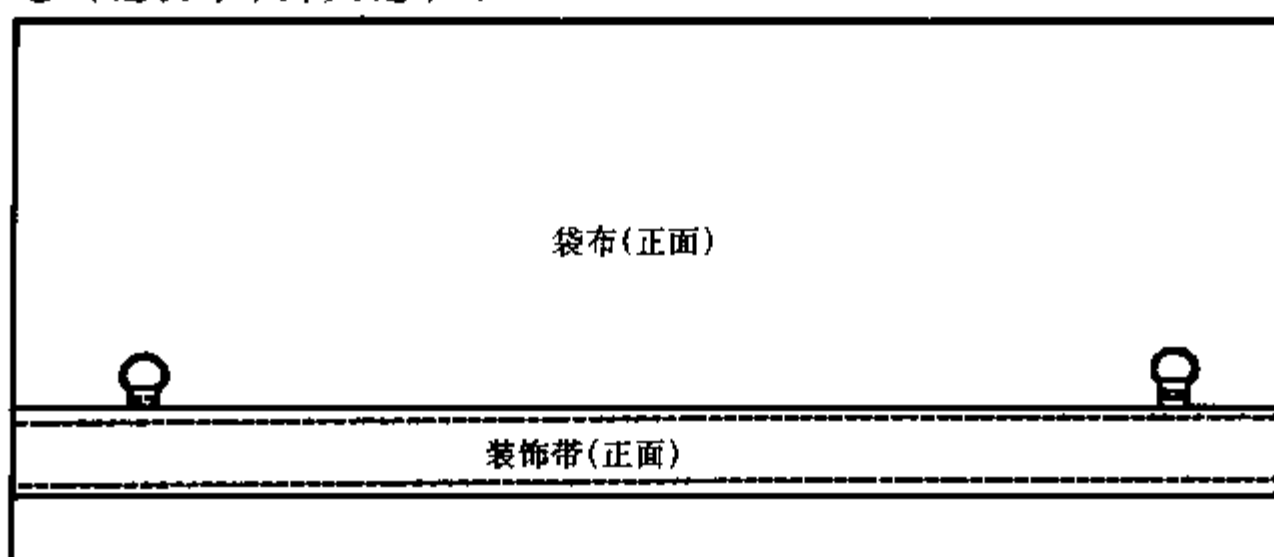

② 钉气眼

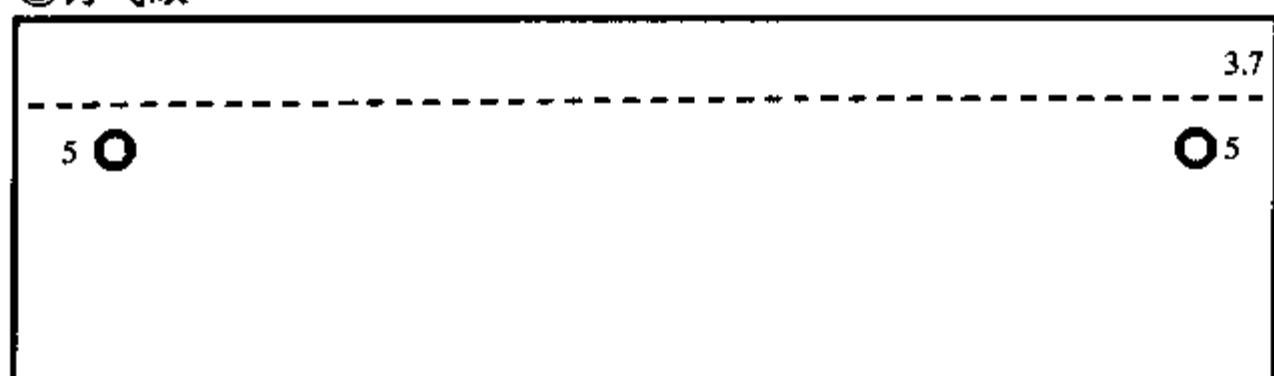

③ 缉缝抽带边

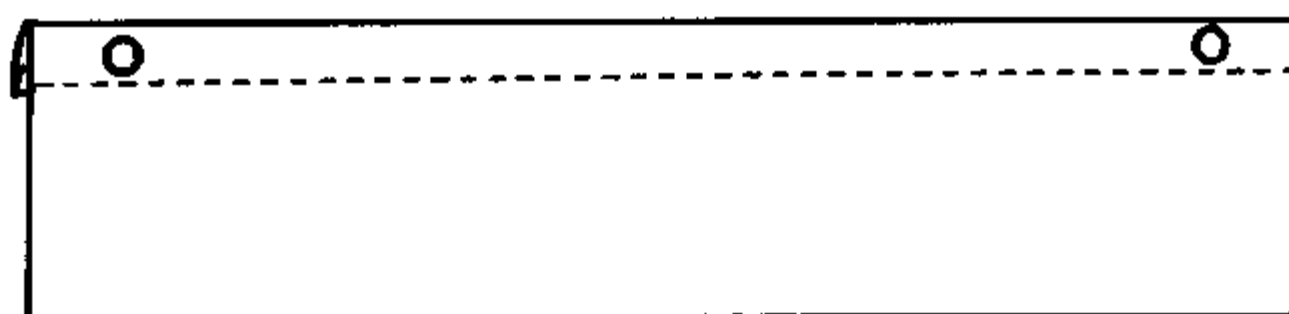

④缝合抽带边

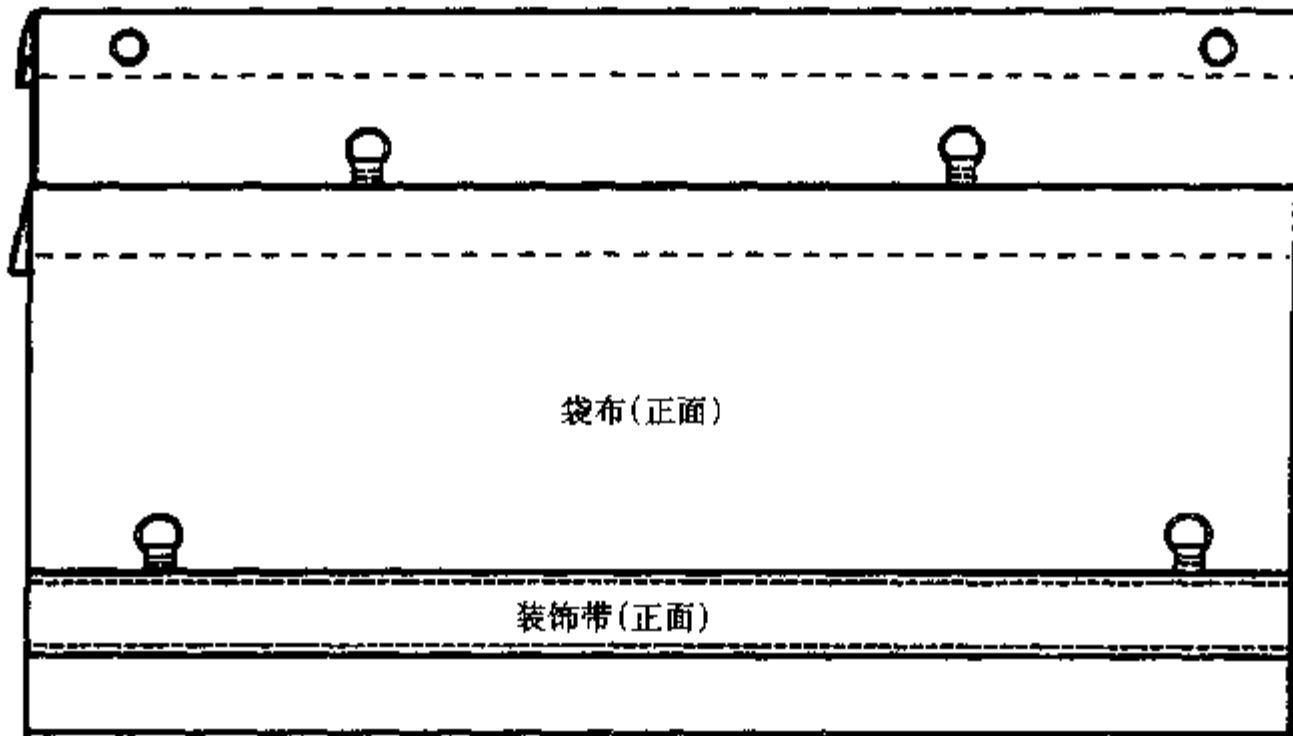

⑤将包后中心缝缝合

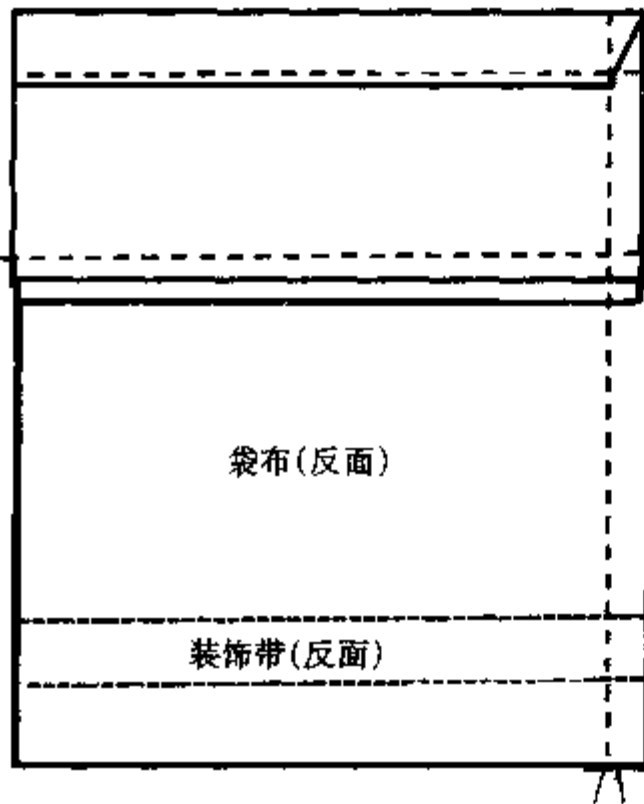

⑦串袋口抽绳

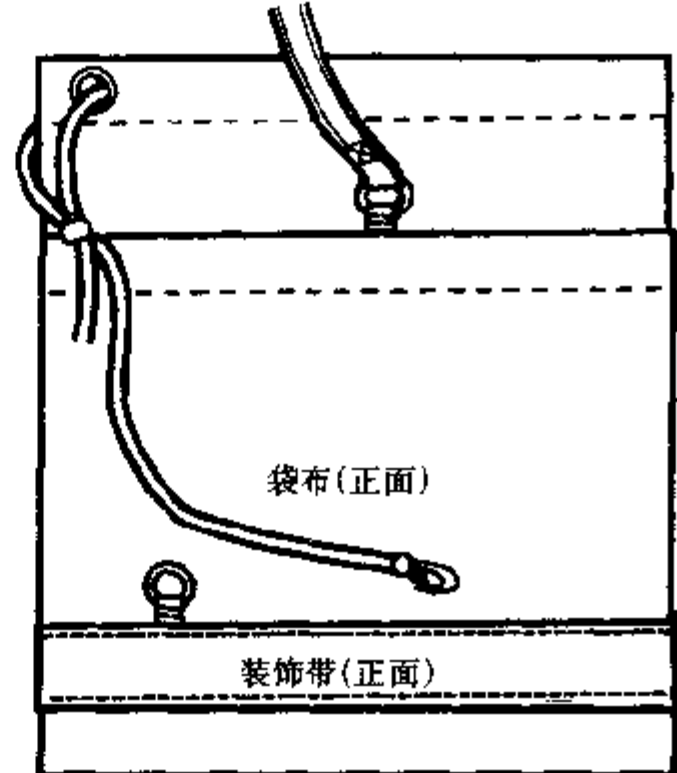

⑥将袋底布与袋身缝合

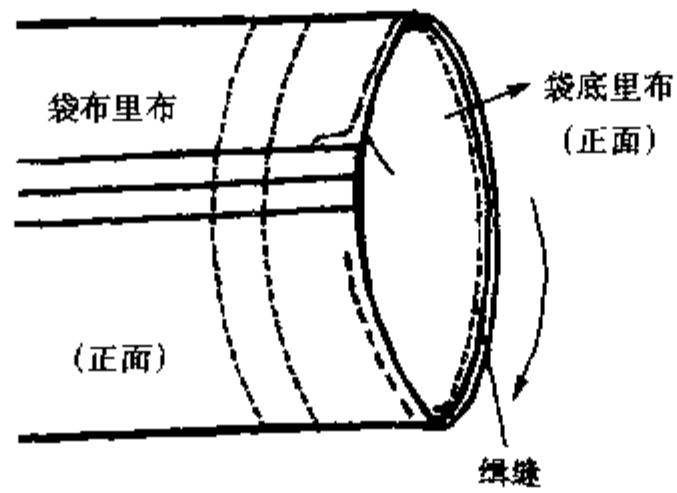



● 少女双肩背袋

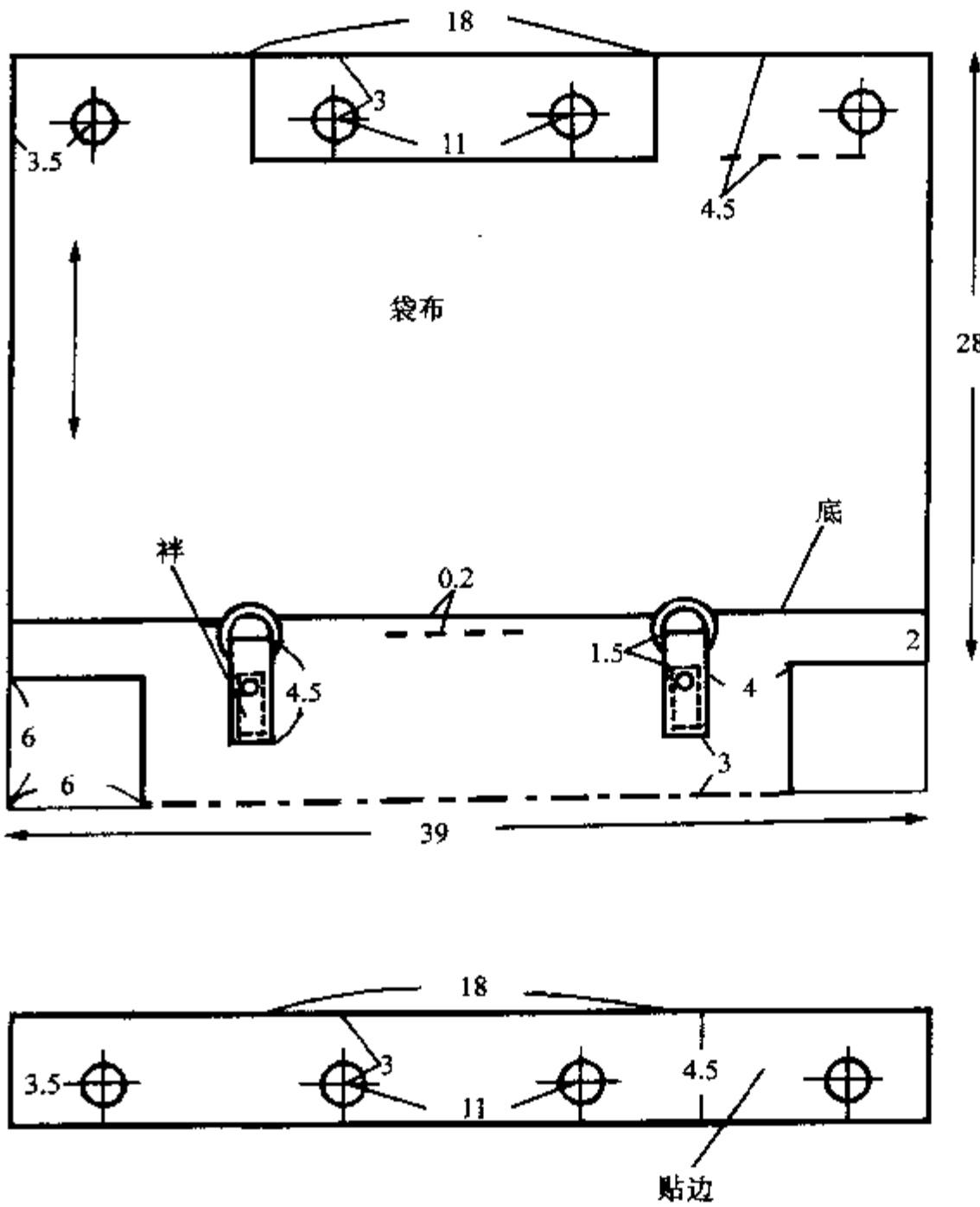
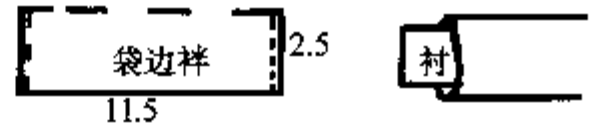

① 缝制背带

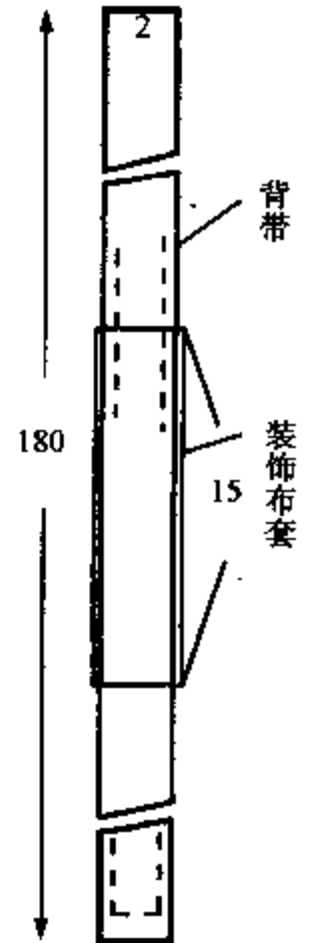

袋盖小布袋

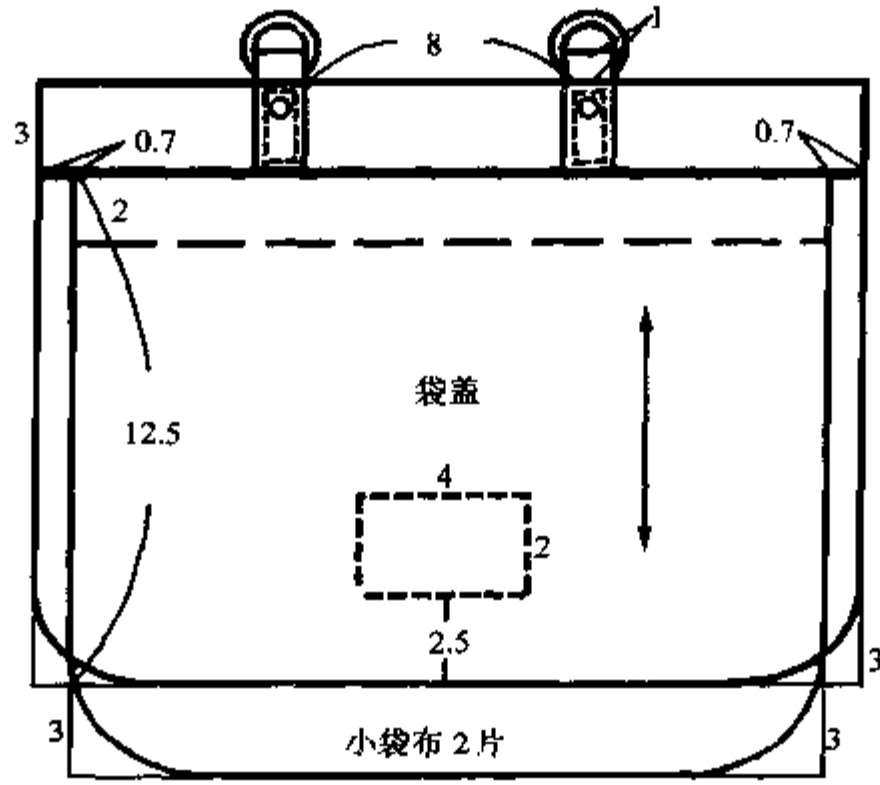

②贴缝大袋底布

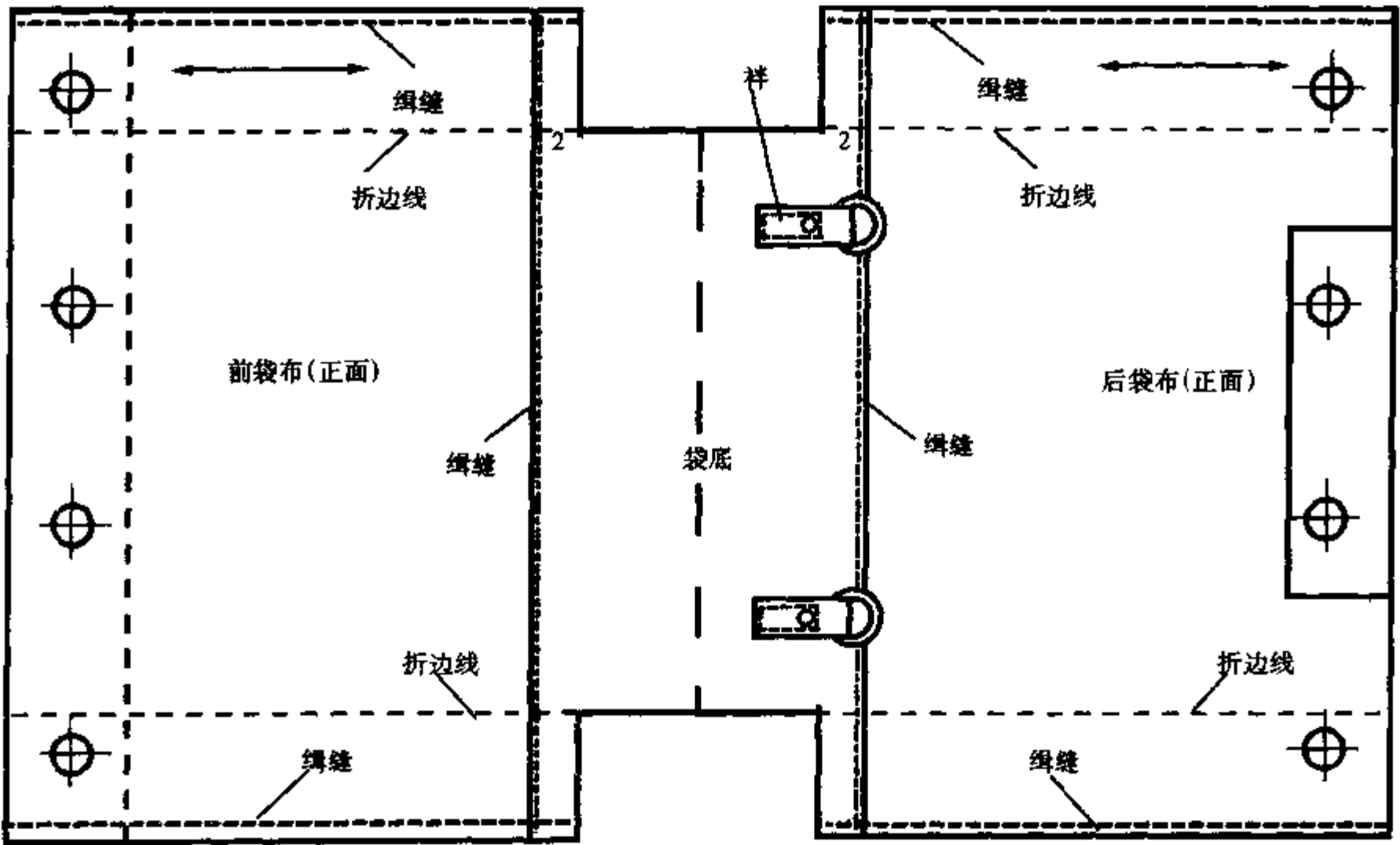

③缝合大袋

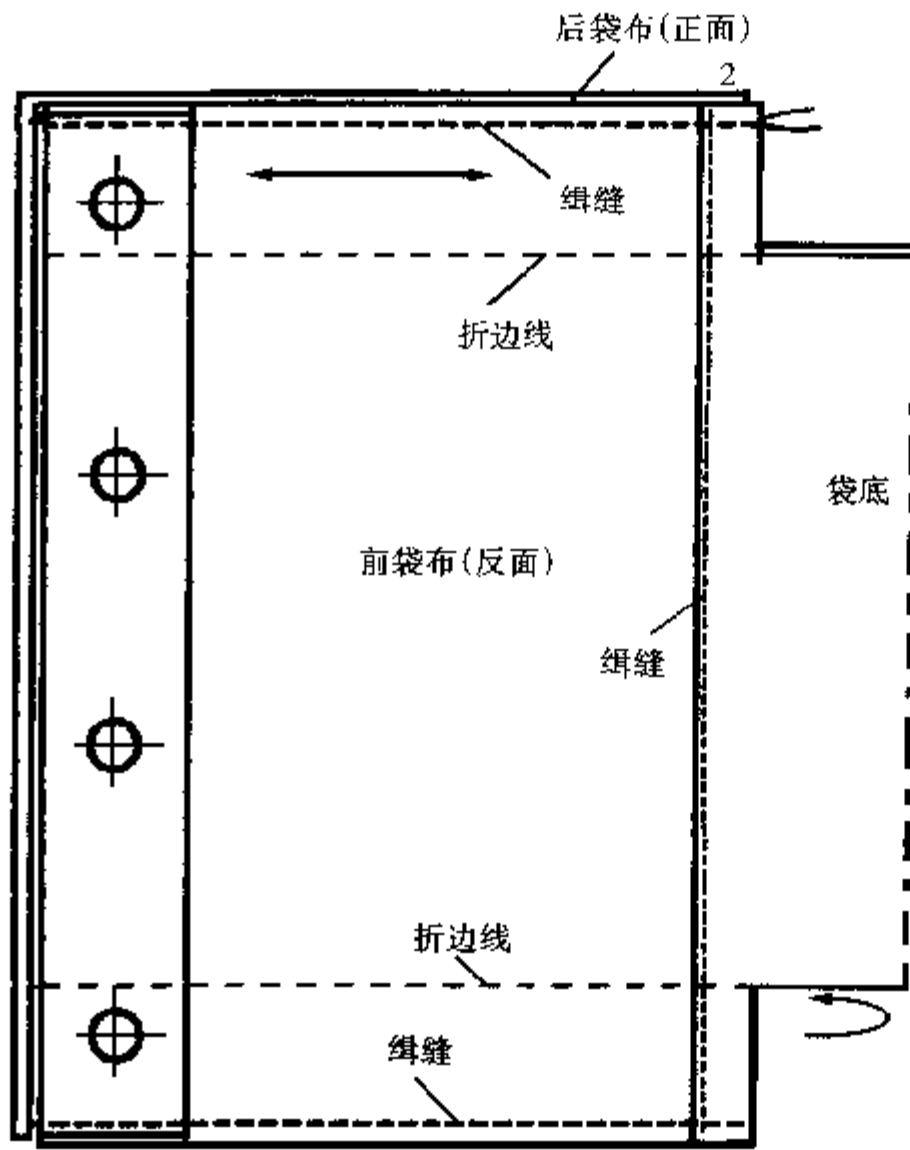

④缝大袋底角

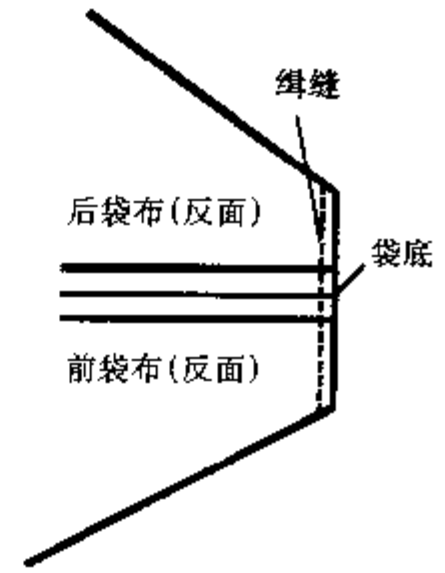

⑤小袋与大袋、袋盖缝合

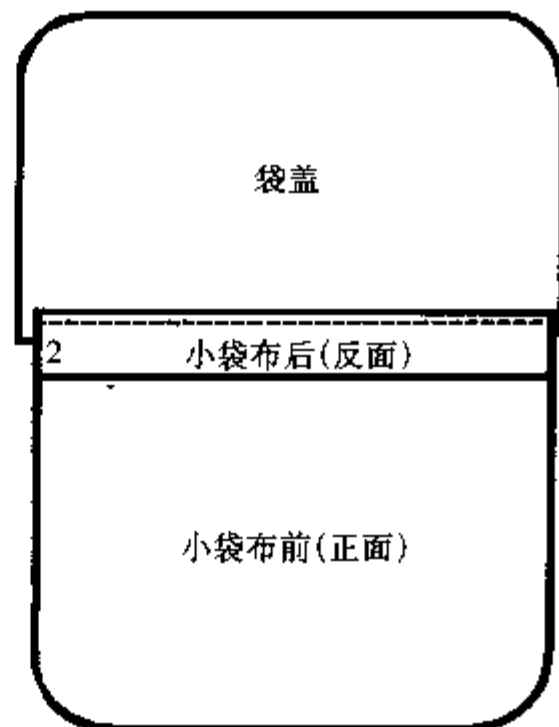
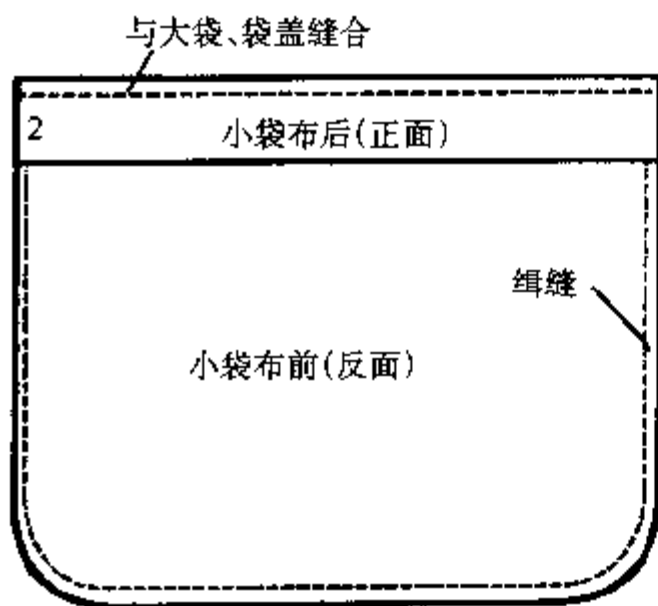



● 休闲购物提袋

加固带(涤纶织带)2条

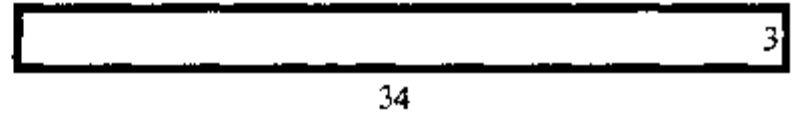

提带(涤纶织带)2条

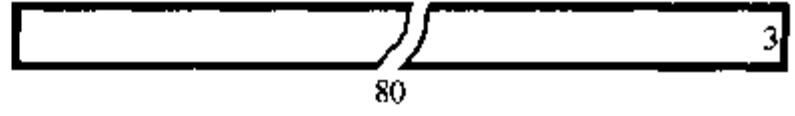

包边带(涤纶织带)

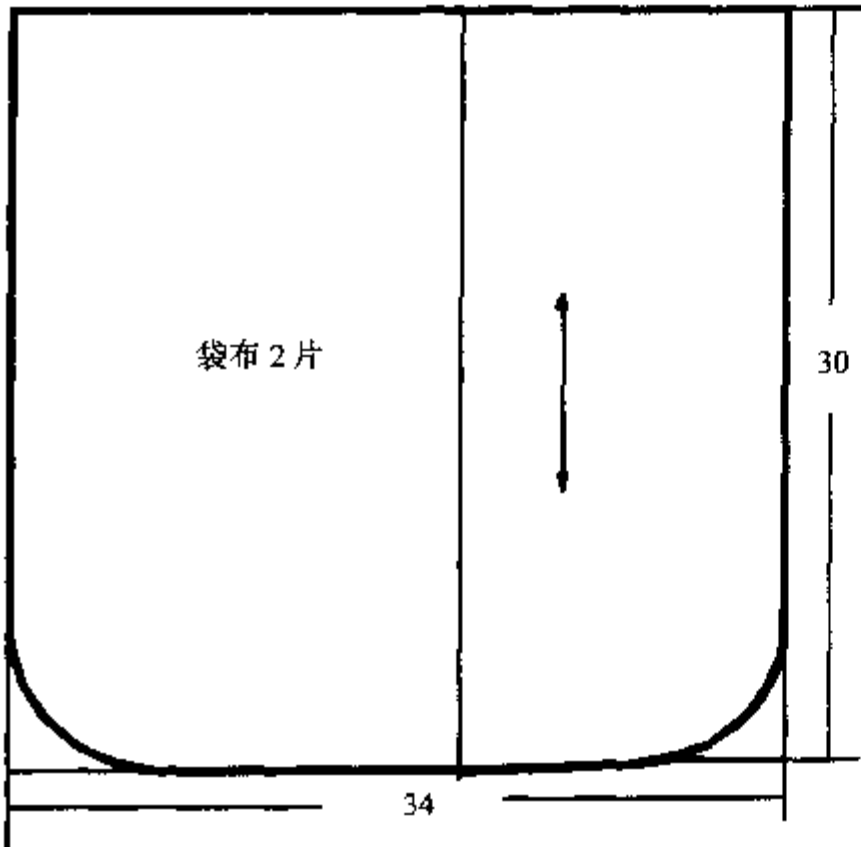
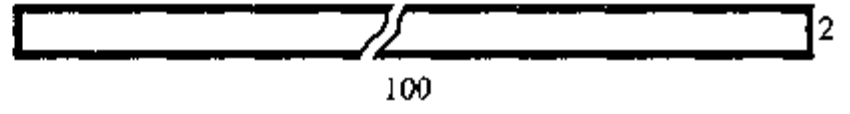

② 纳拉链

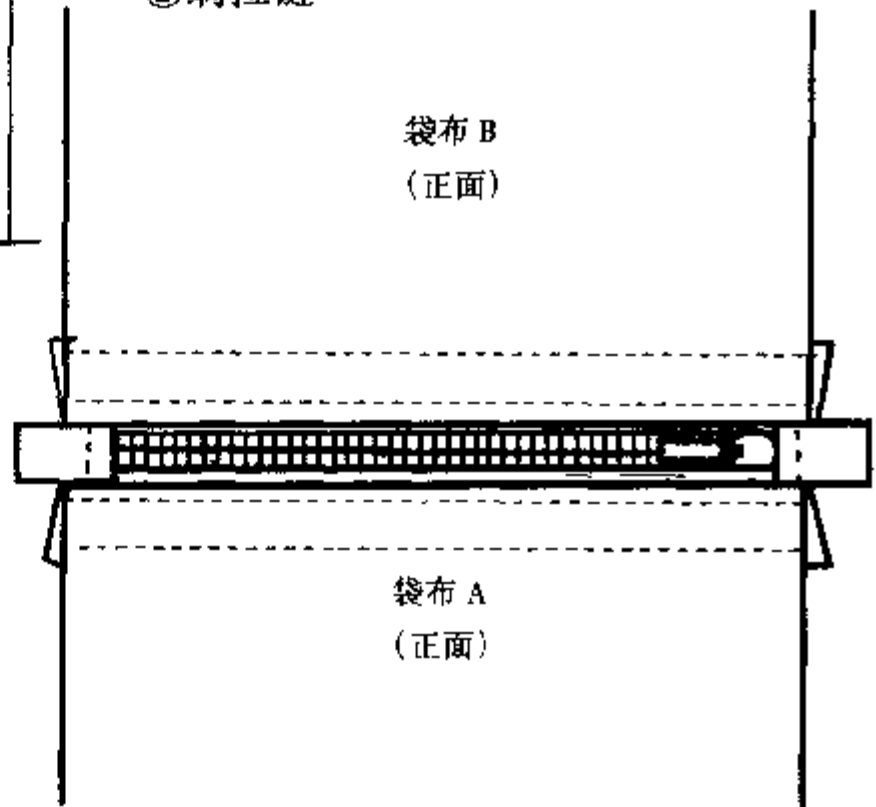

① 缝拉链两端辅助布

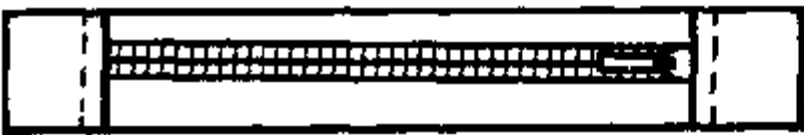

③ 缉缝加固带及提带(涤纶织带)

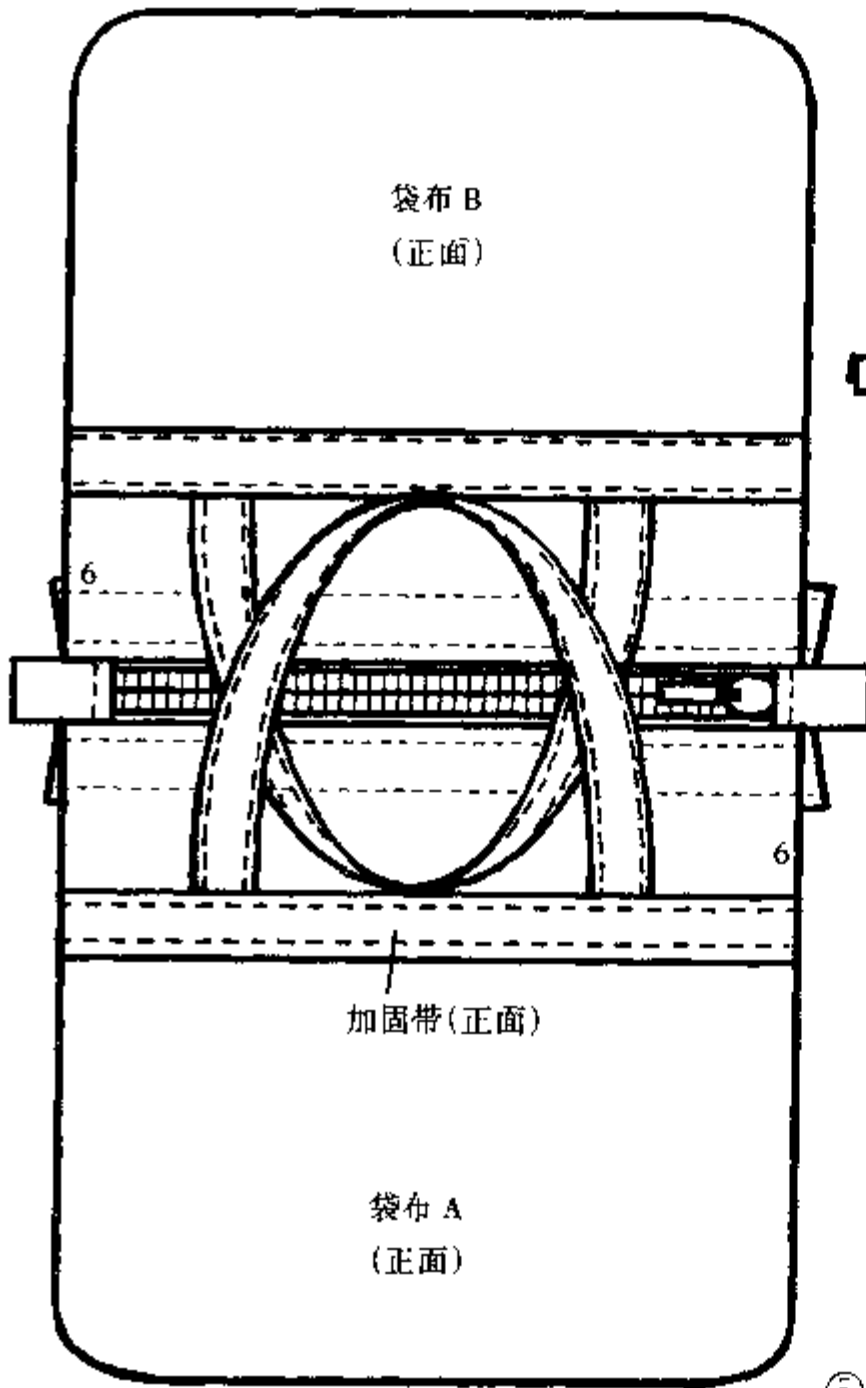

④ 缝合袋布

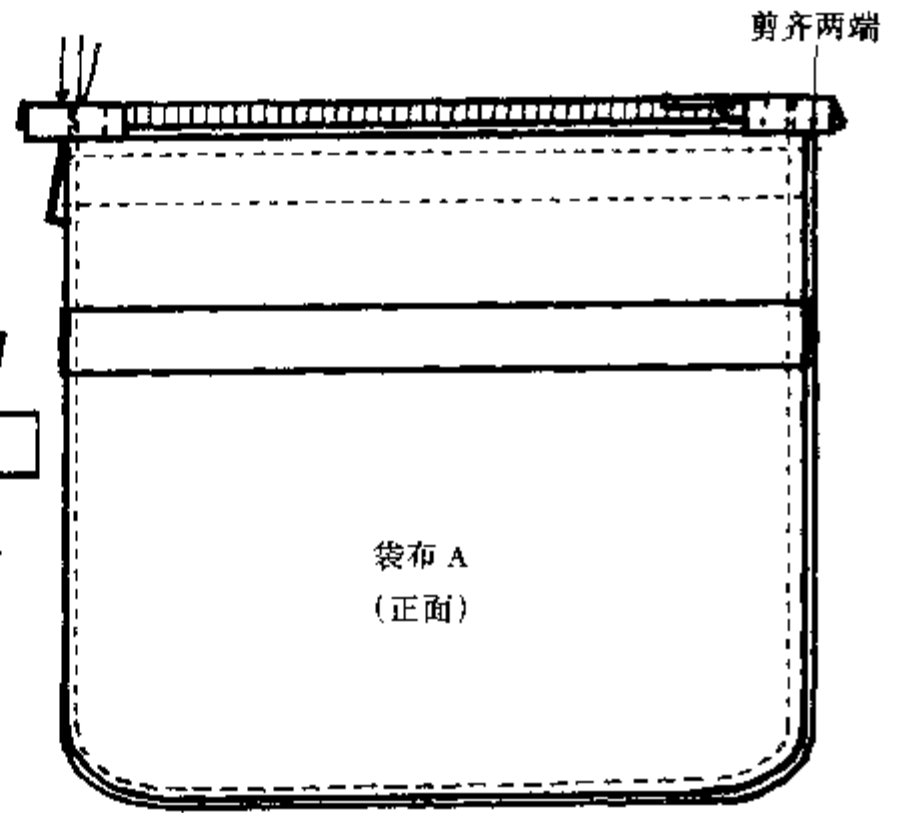

⑤ 缉缝包边带

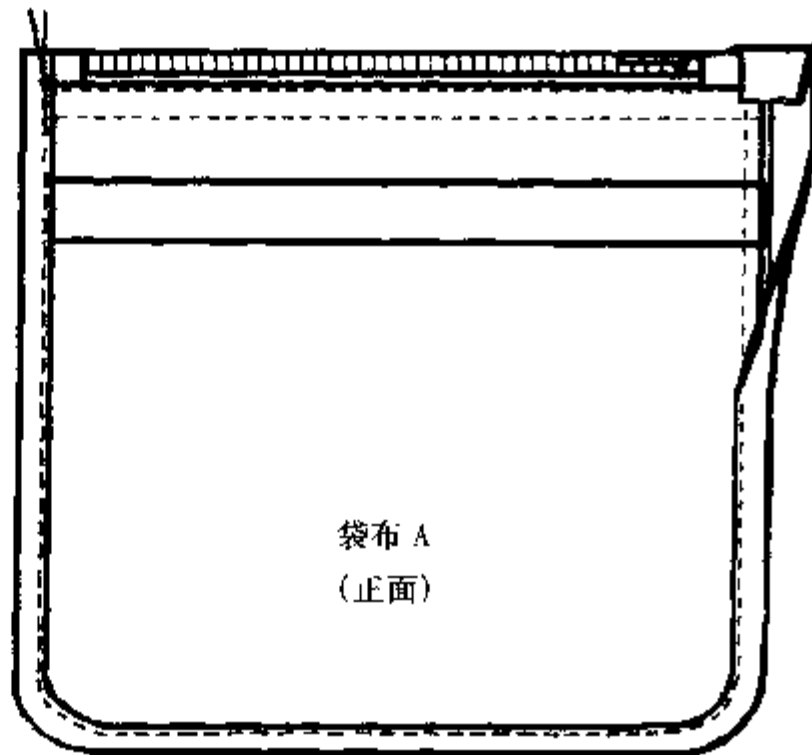

● 折叠方便袋

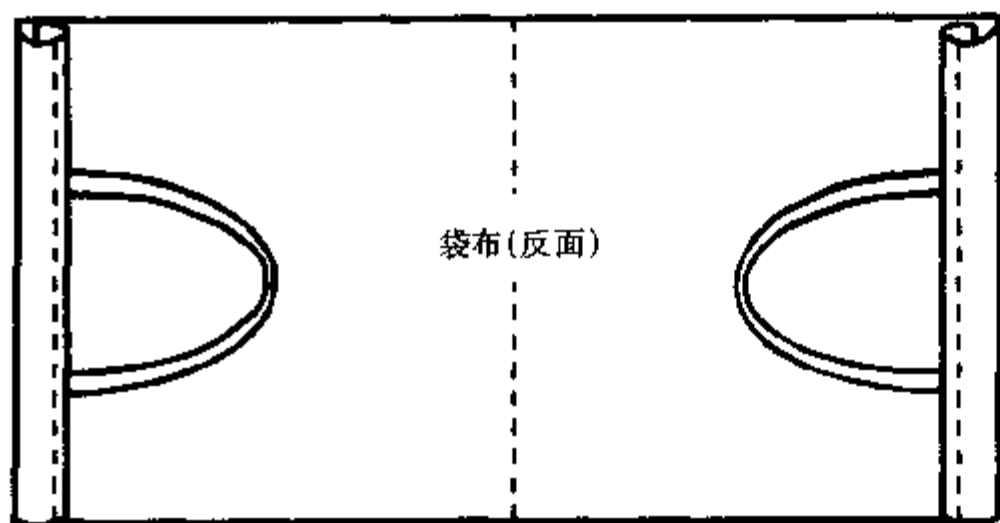
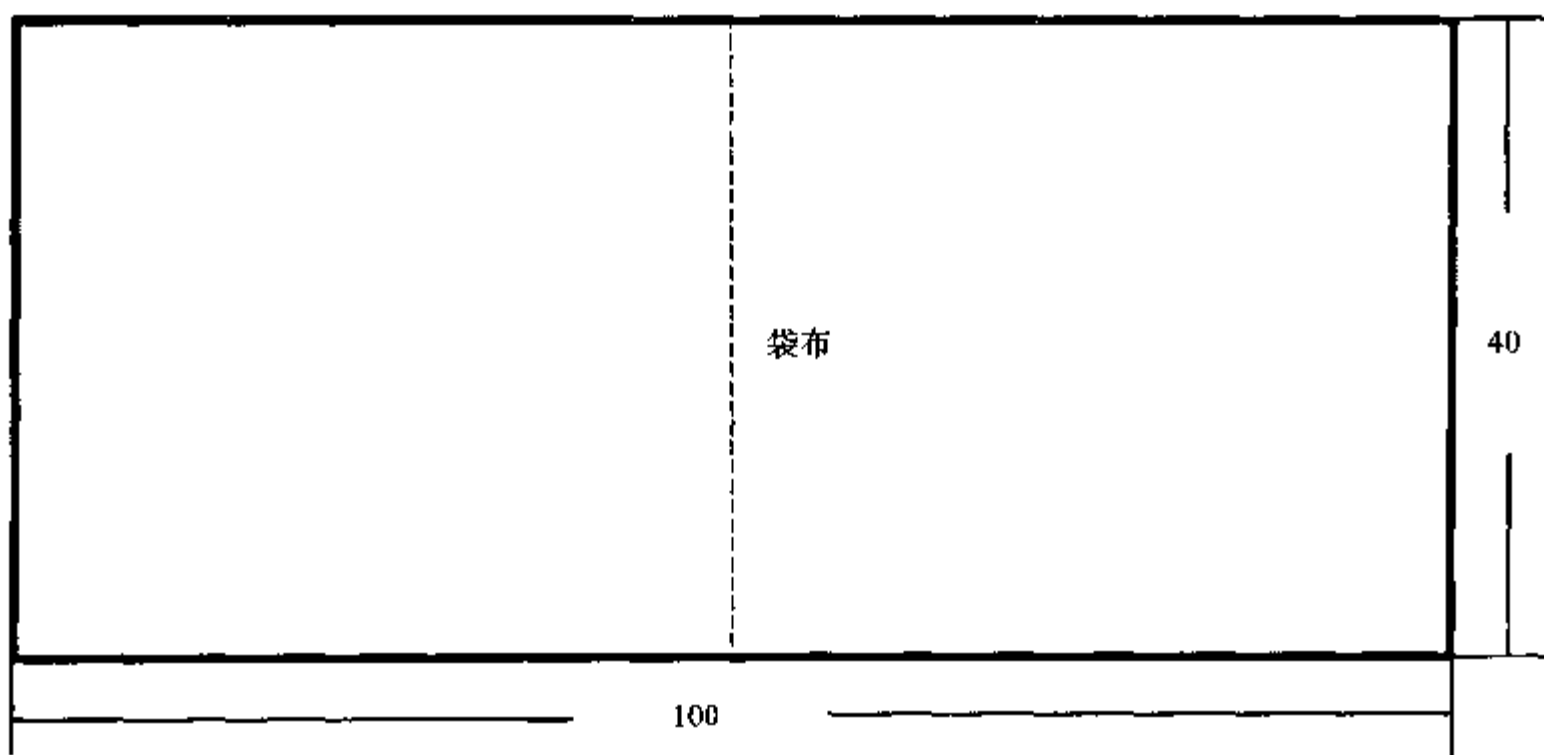
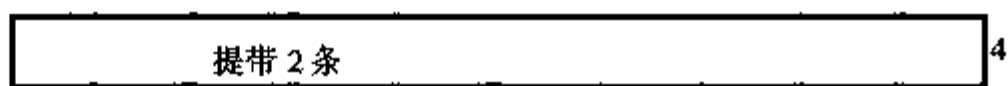
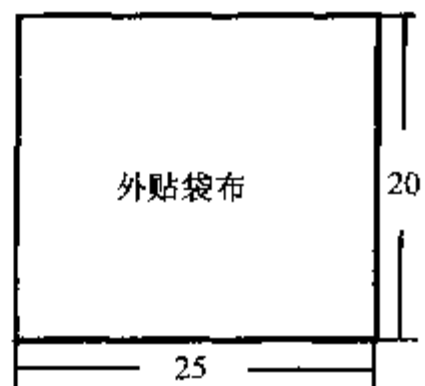
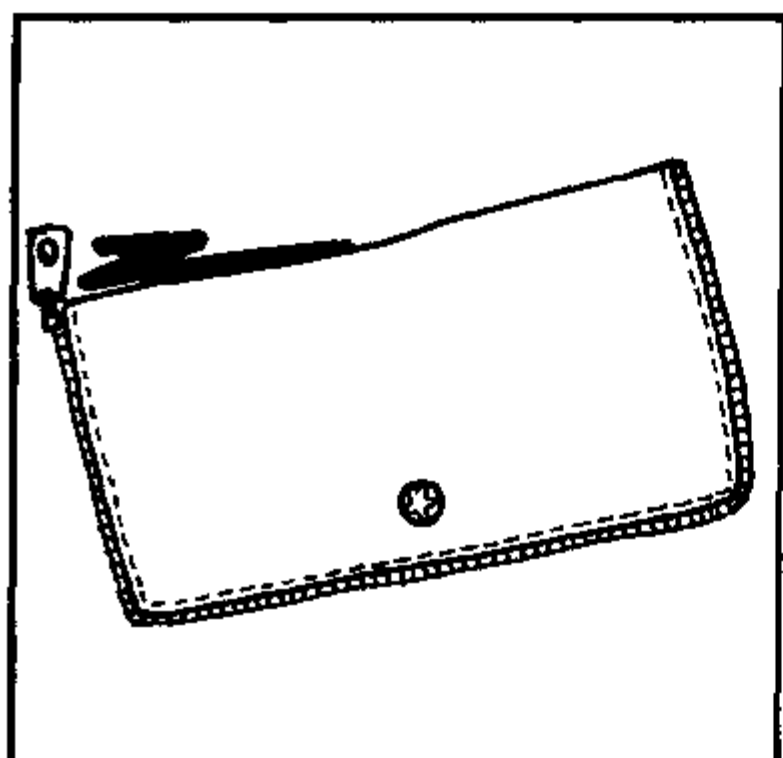

① 折袋口边

②折边压缝拉链

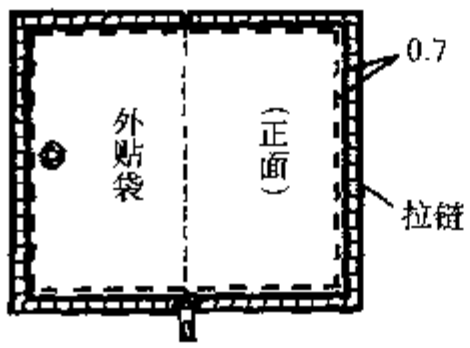

③缝合外贴袋

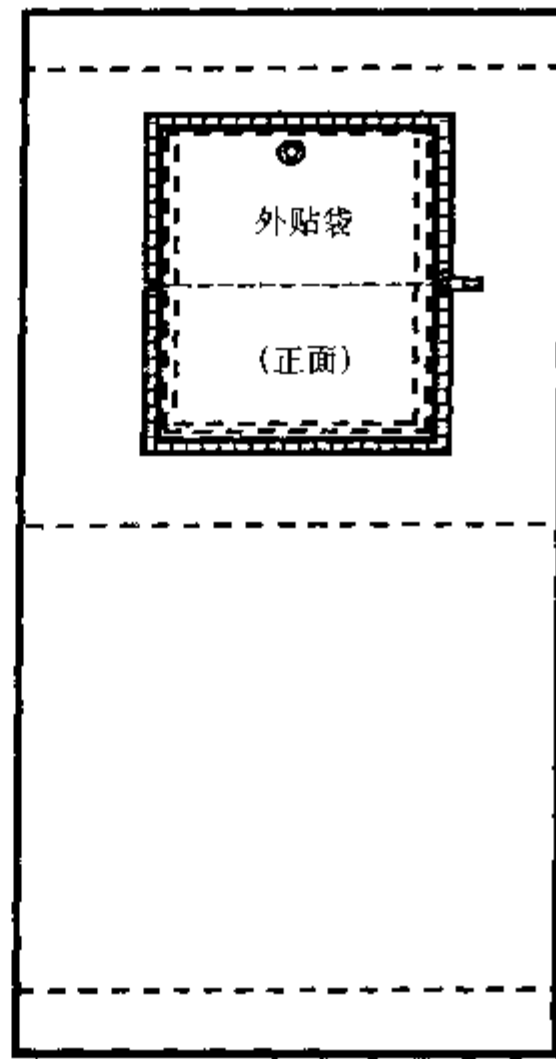

④缝合袋布

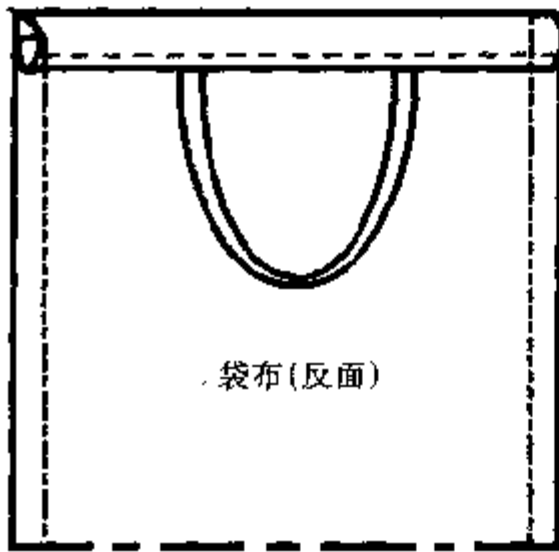

⑤缝合袋布底角

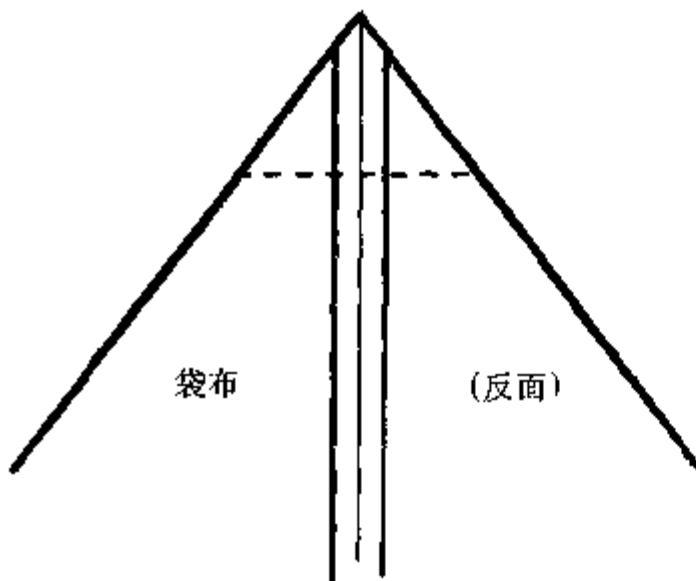

⑥缉缝袋布明线

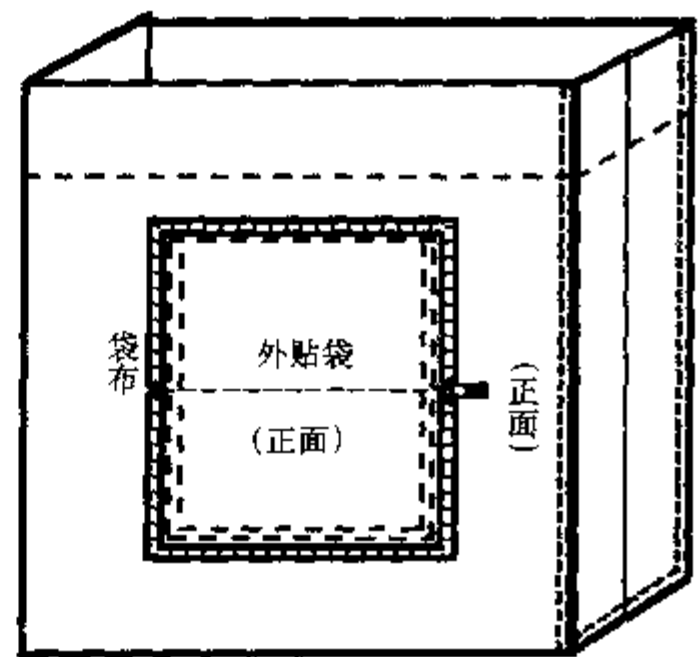

⑦ 缉缝袋口拉链

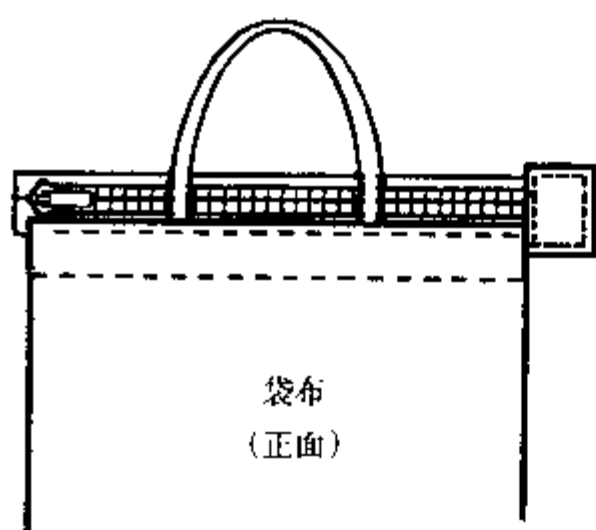

⑧ 成品效果

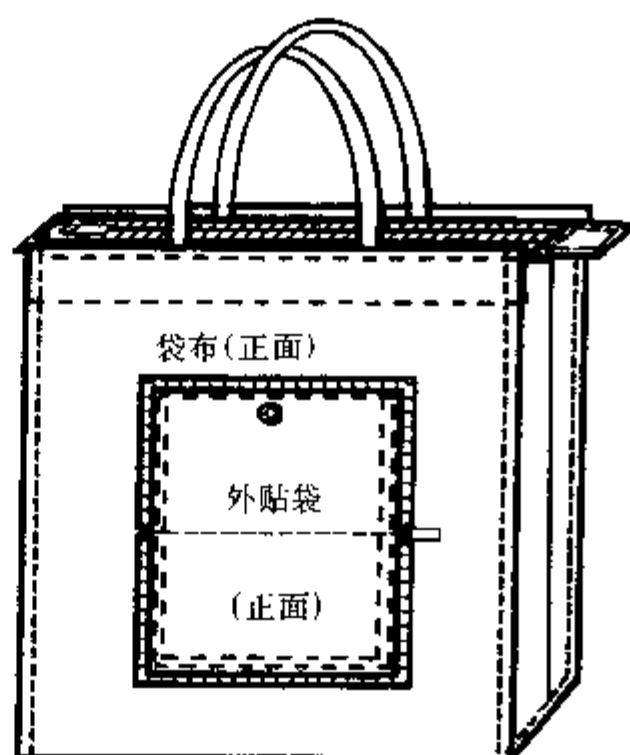

● 抽口双肩背袋

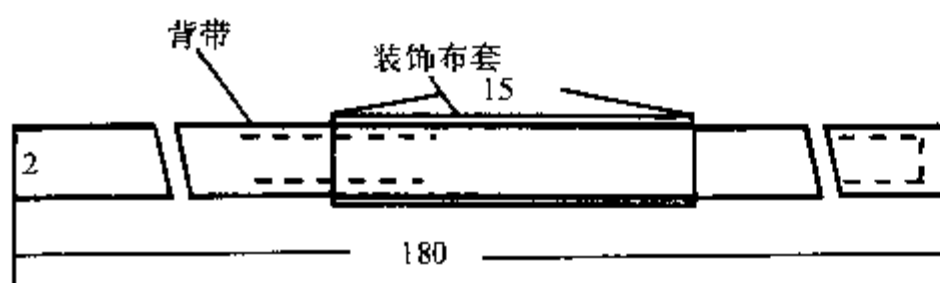
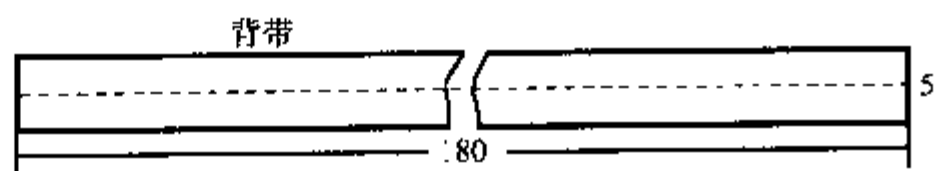
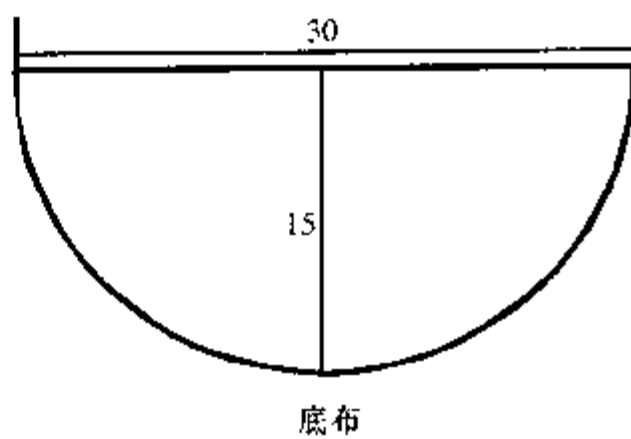

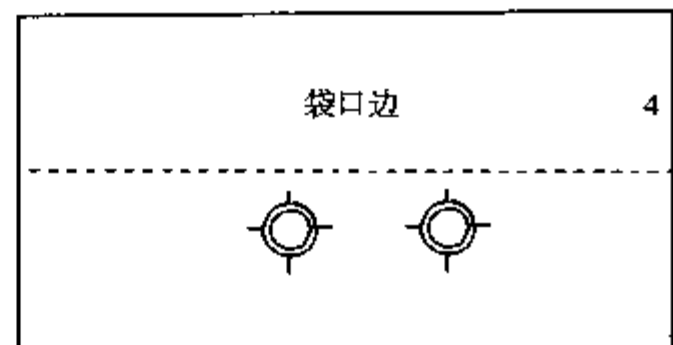
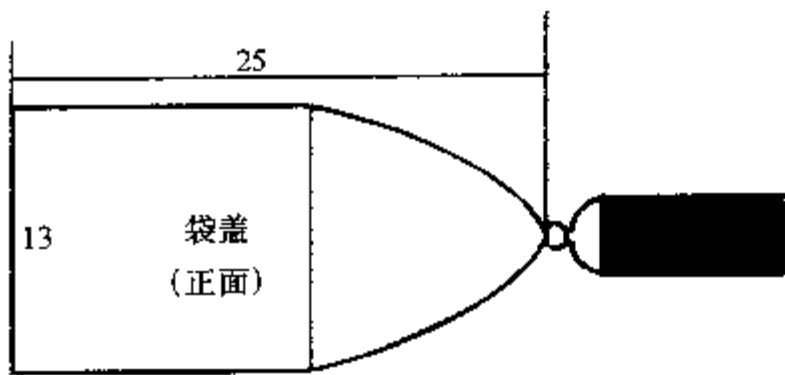
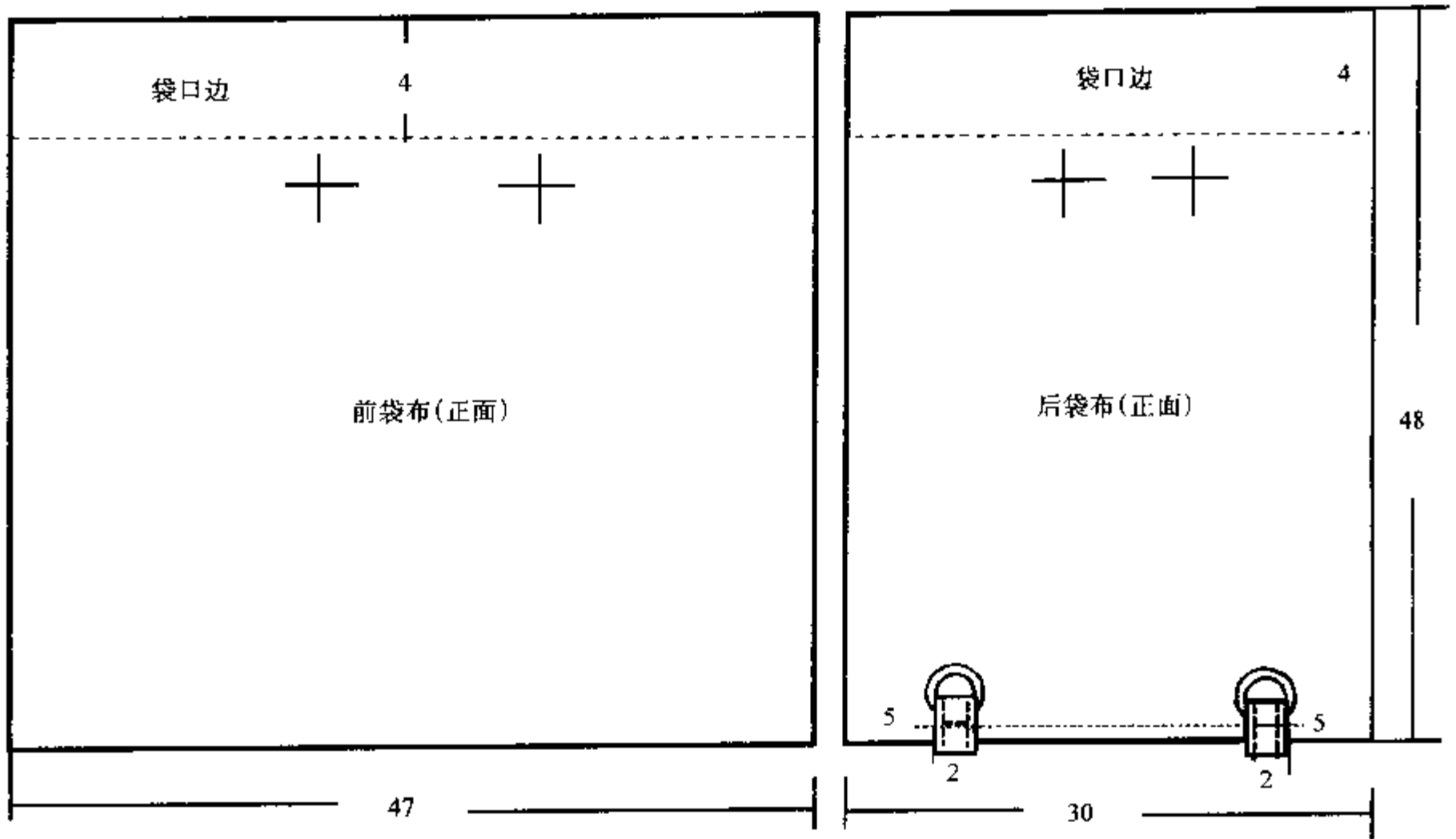

①钉气眼

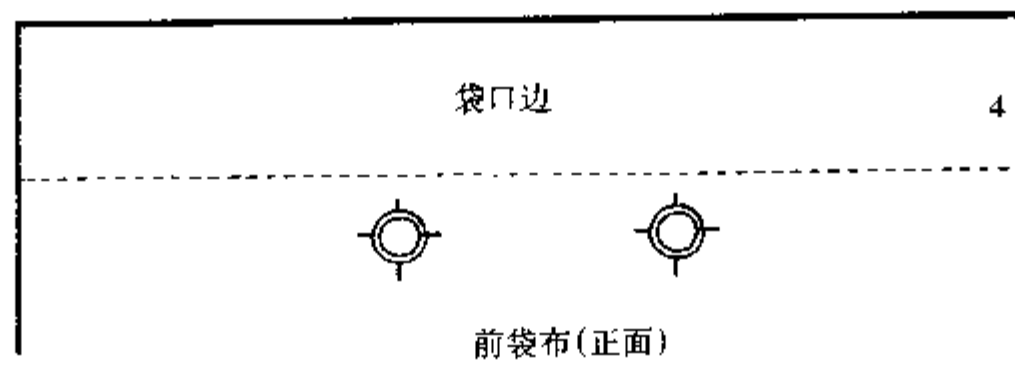

②缝合袋布

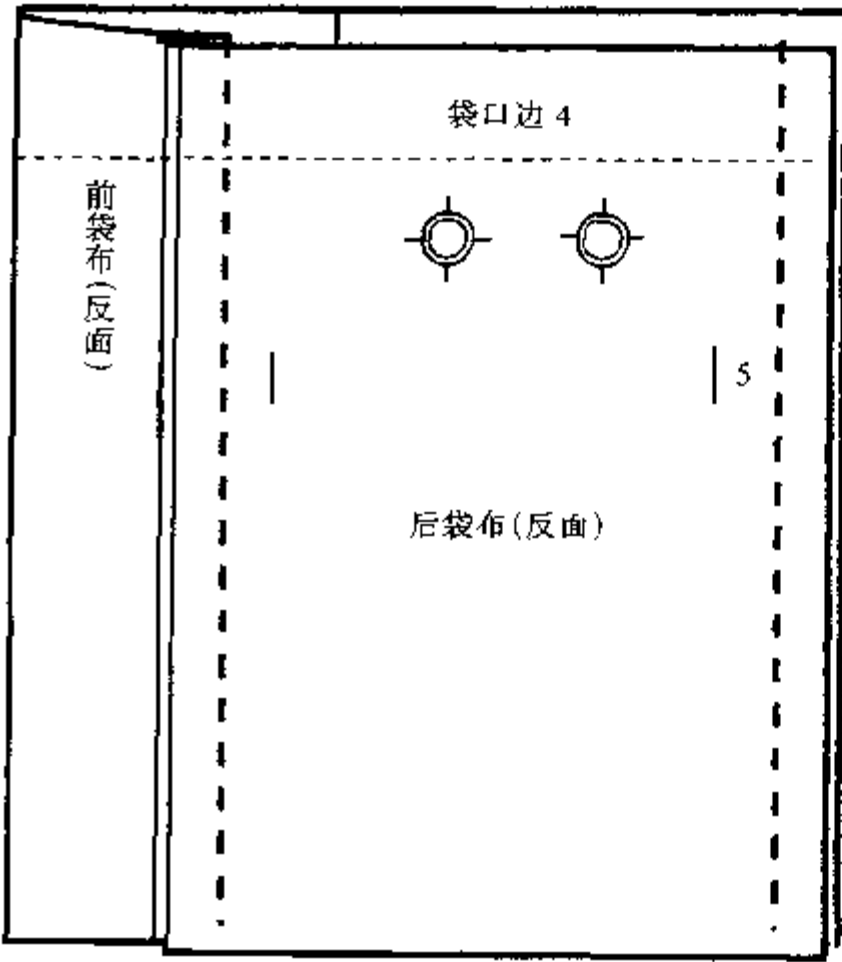

③劈开缝份

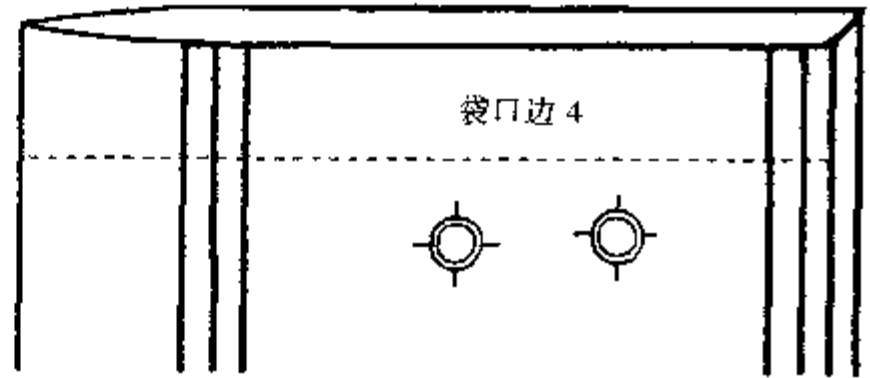

④折缝袋口边

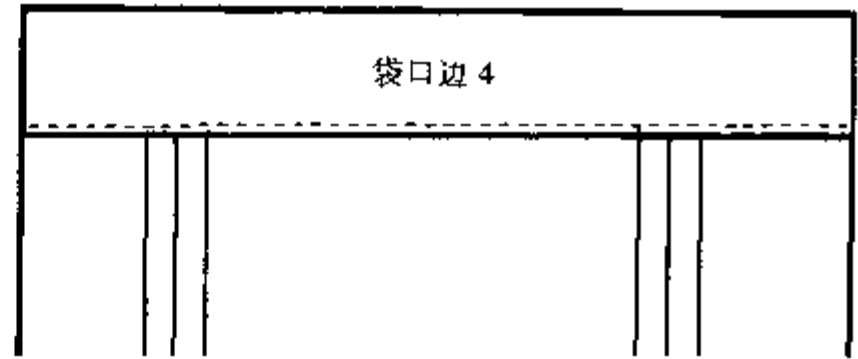

⑤缝合后袋底

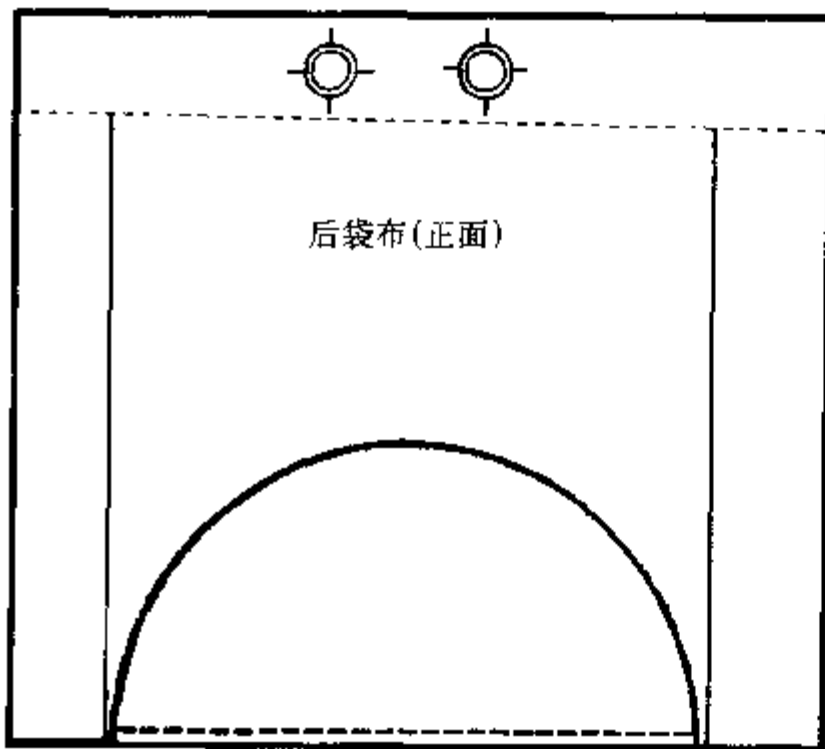

后袋底边与袋底直边缝合

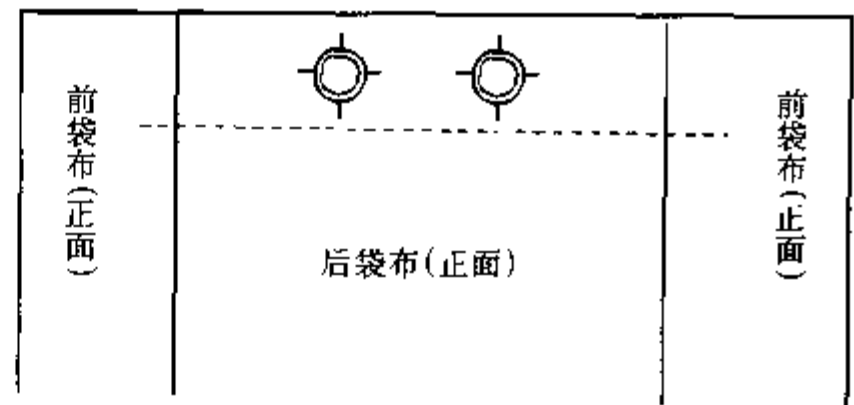

⑥缝合前袋底

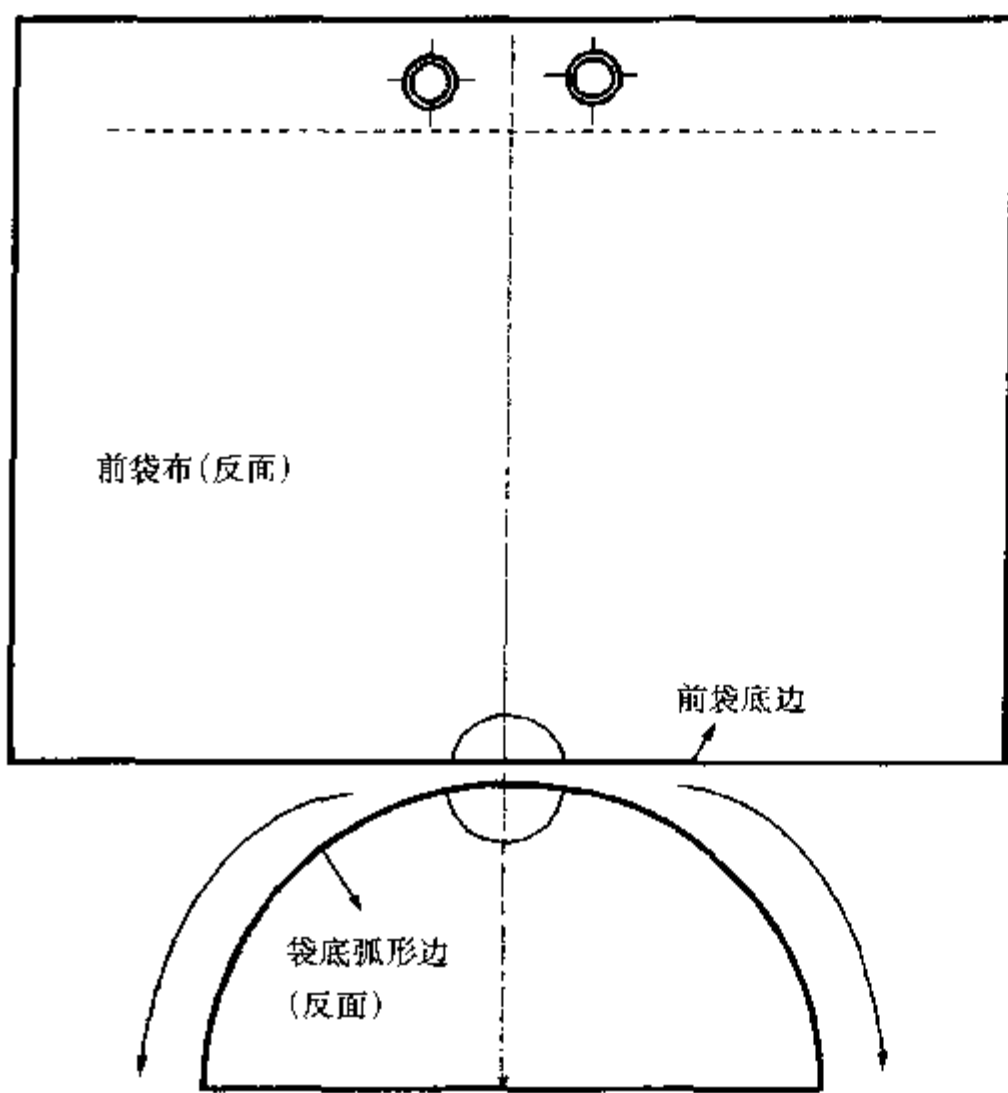

前袋底边与袋底弧形边缝合

⑦缝合袋盖

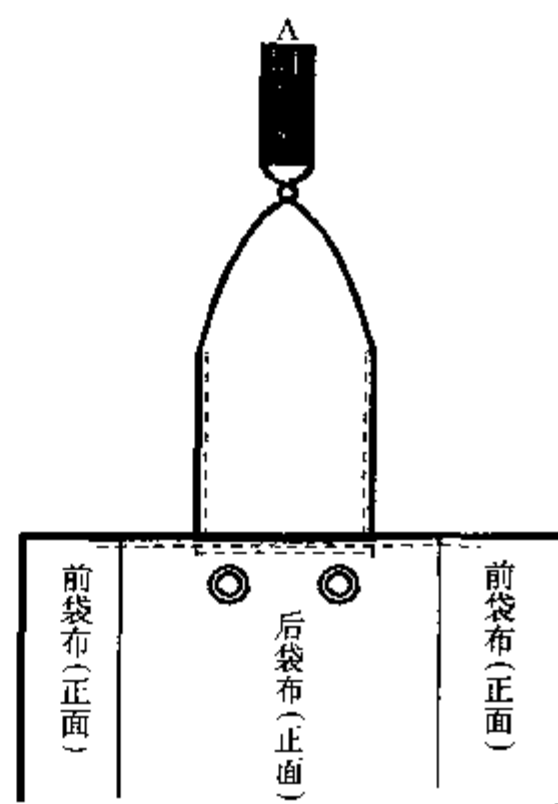

⑧袋盖完成效果

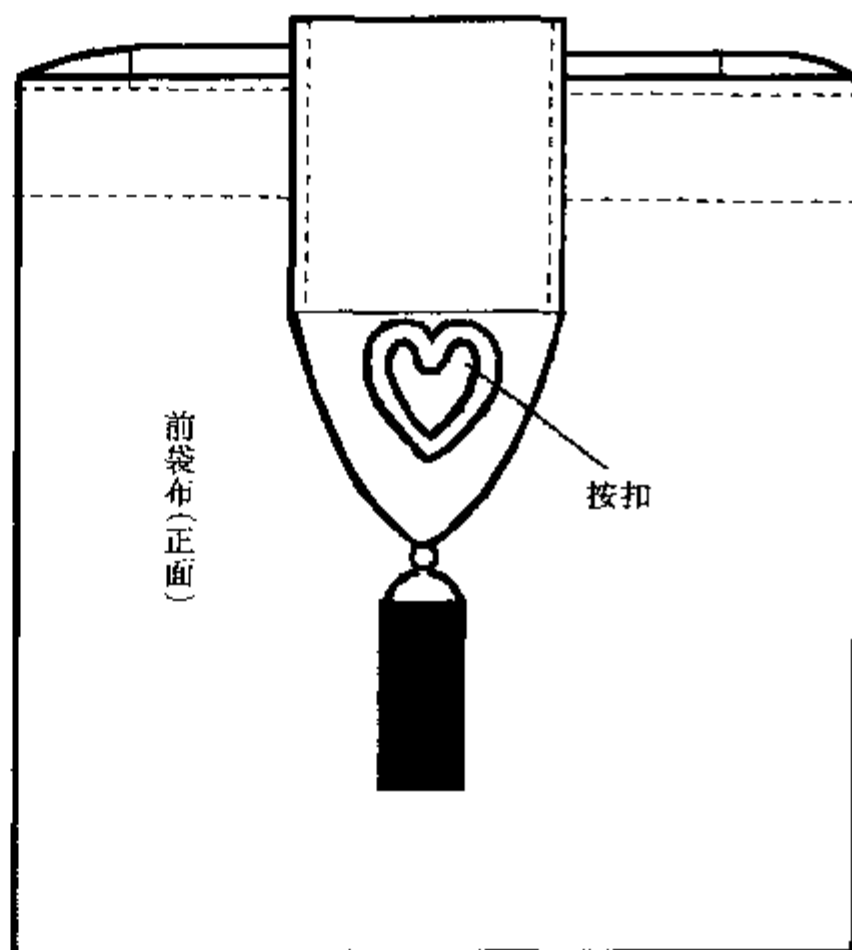
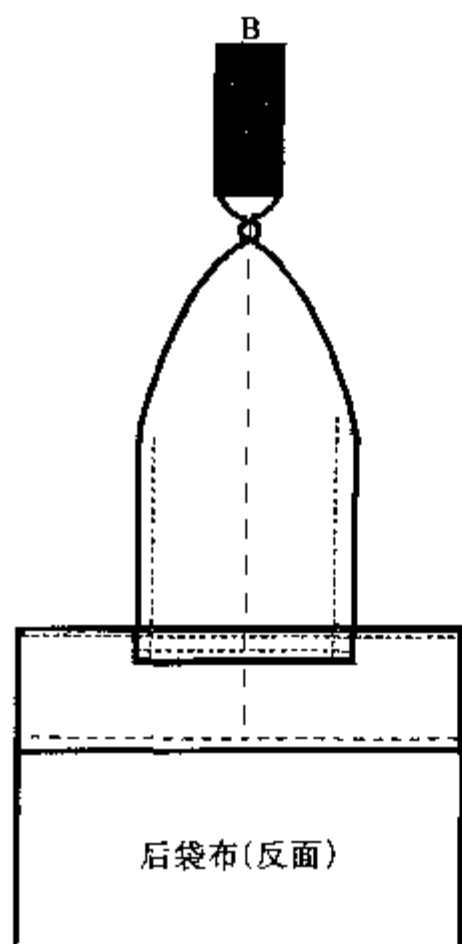

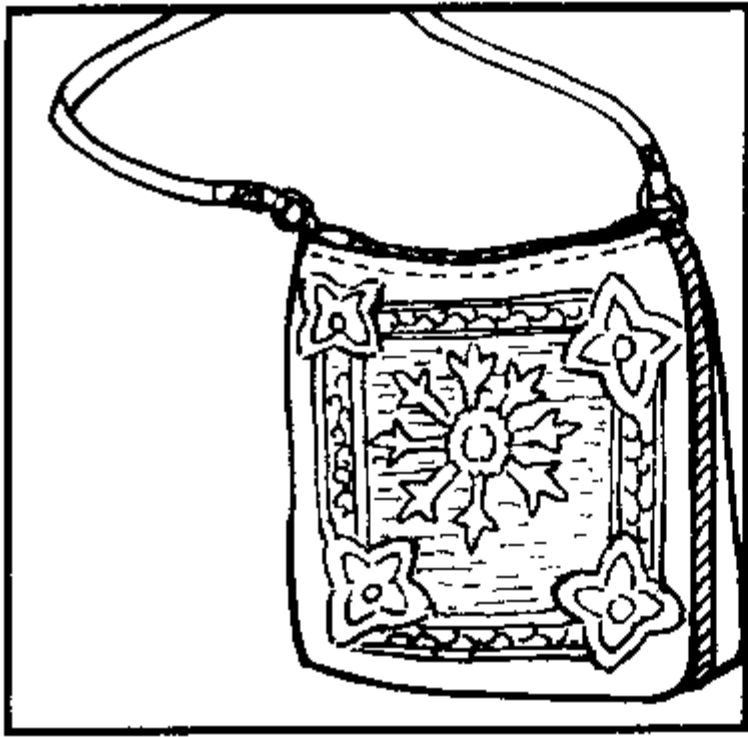

● 淑女挎肩袋

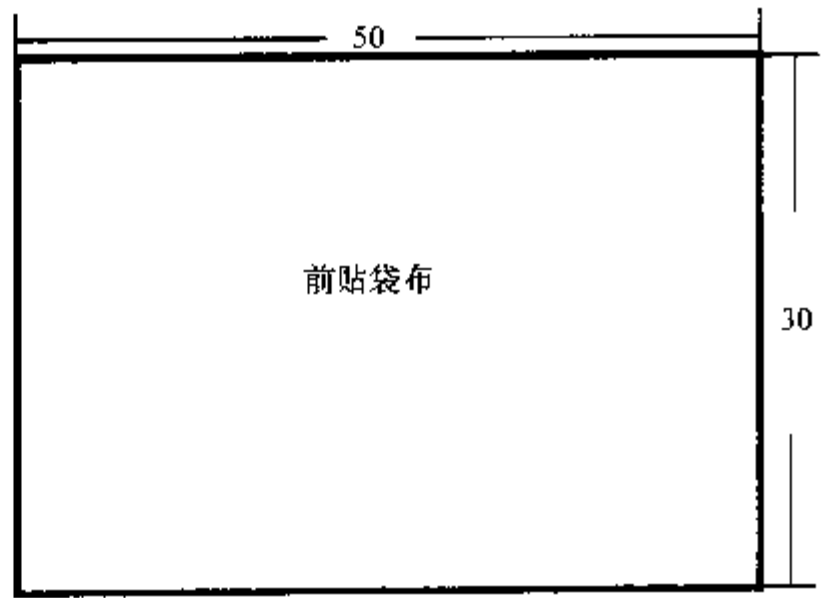
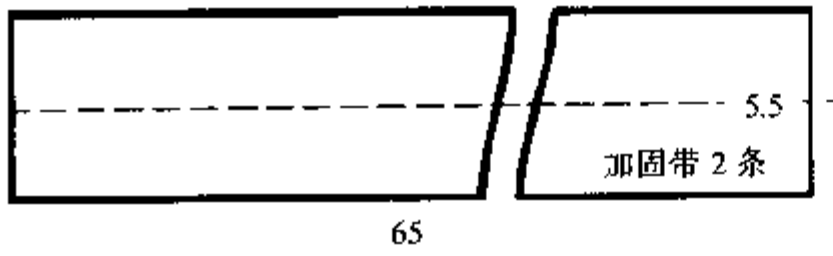
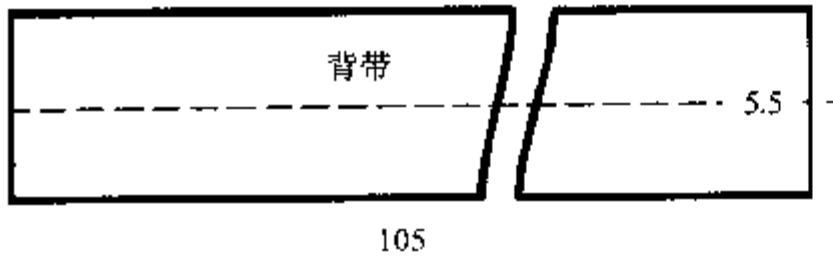
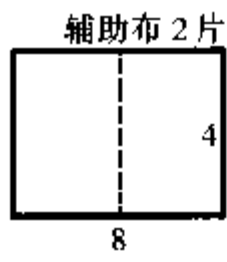
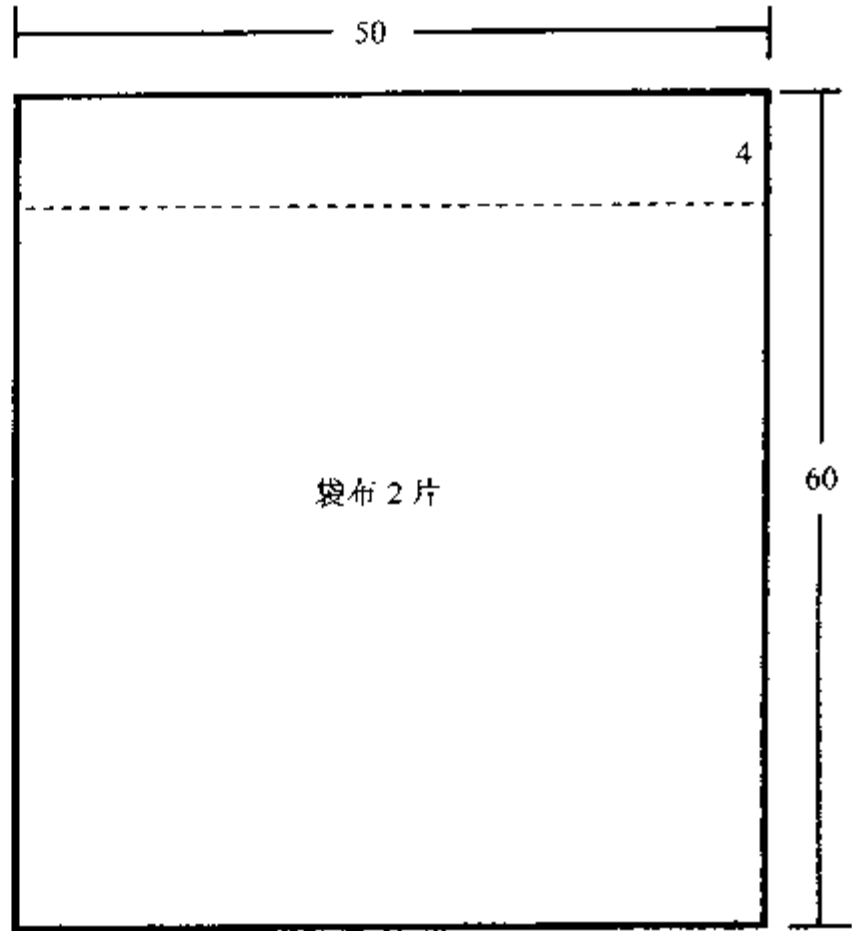

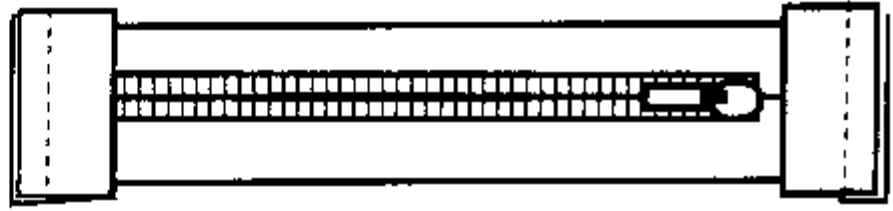

①缝合辅助部件

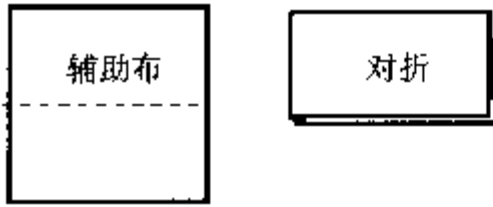

④缝合后贴袋布

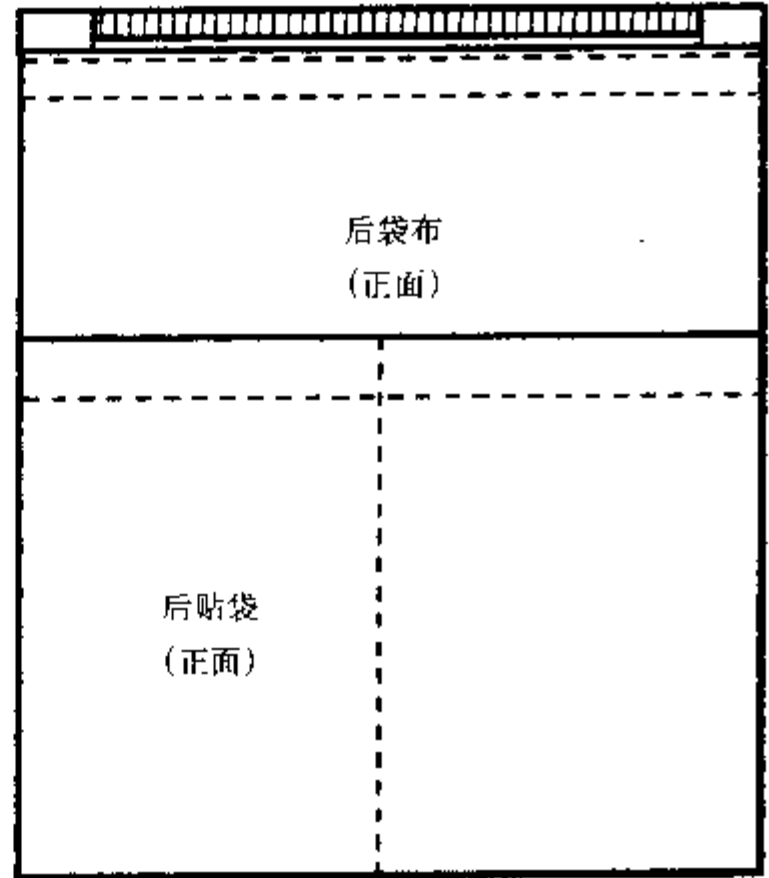

②缉拉链

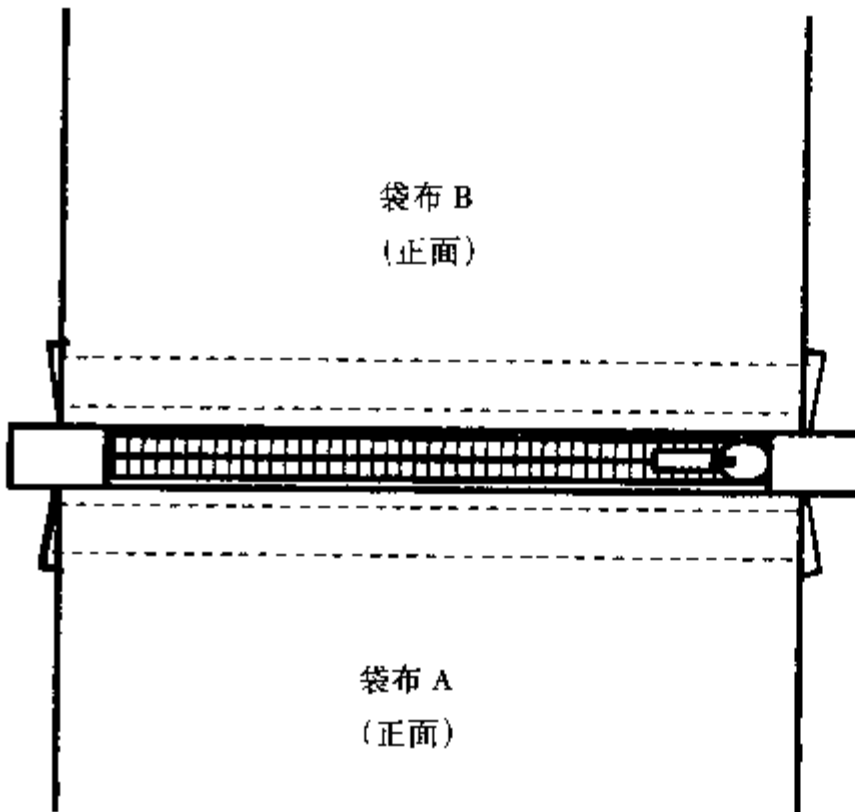

⑤缝合前、后袋布

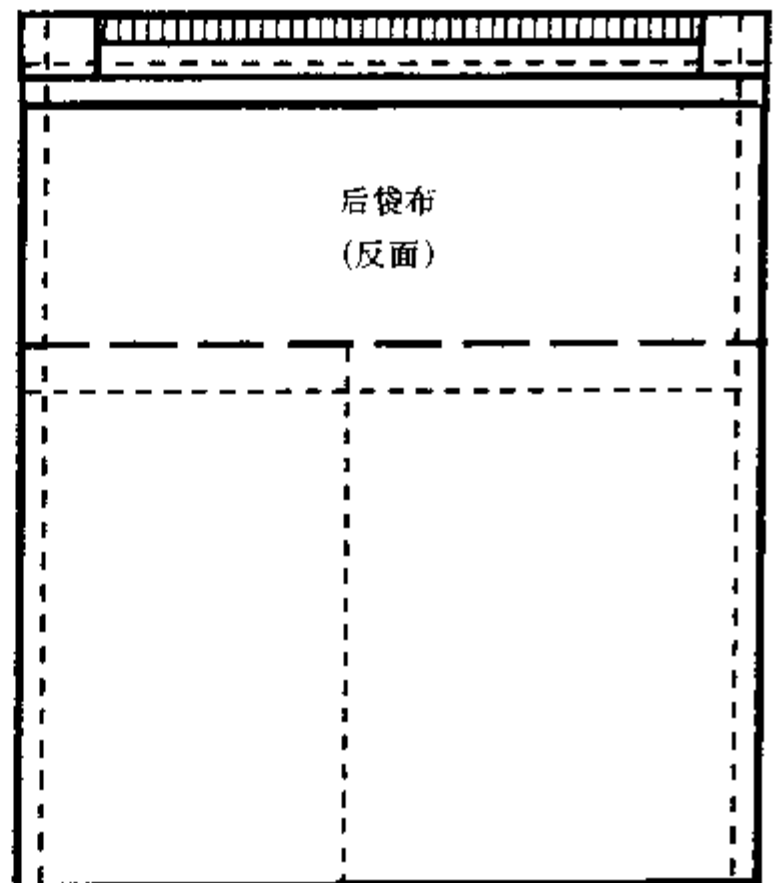

③扣折加固带边

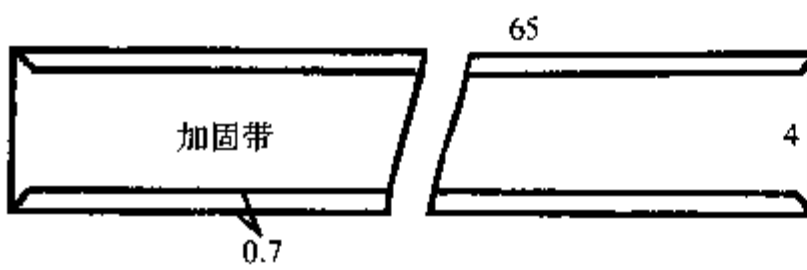

⑥缝合加固带

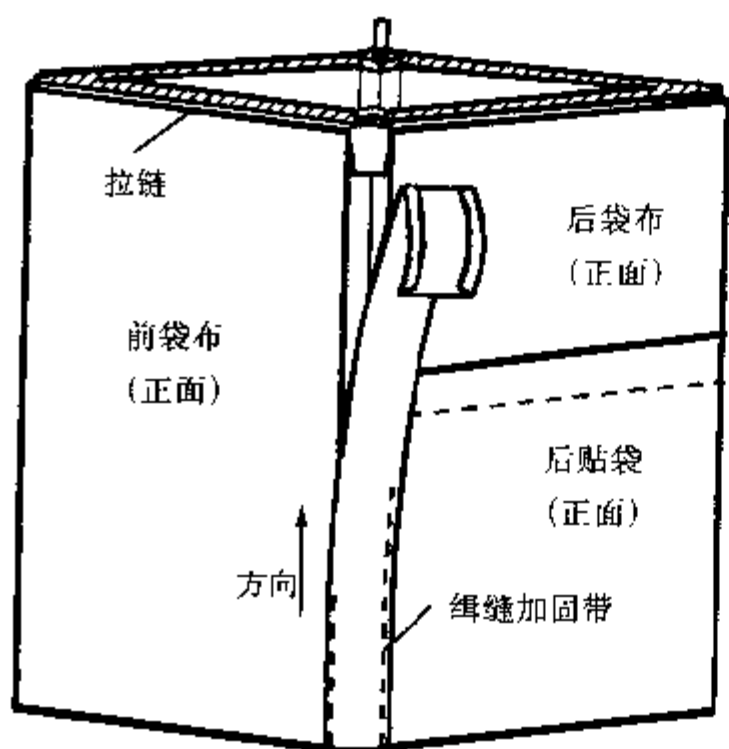

⑦缝合袋底

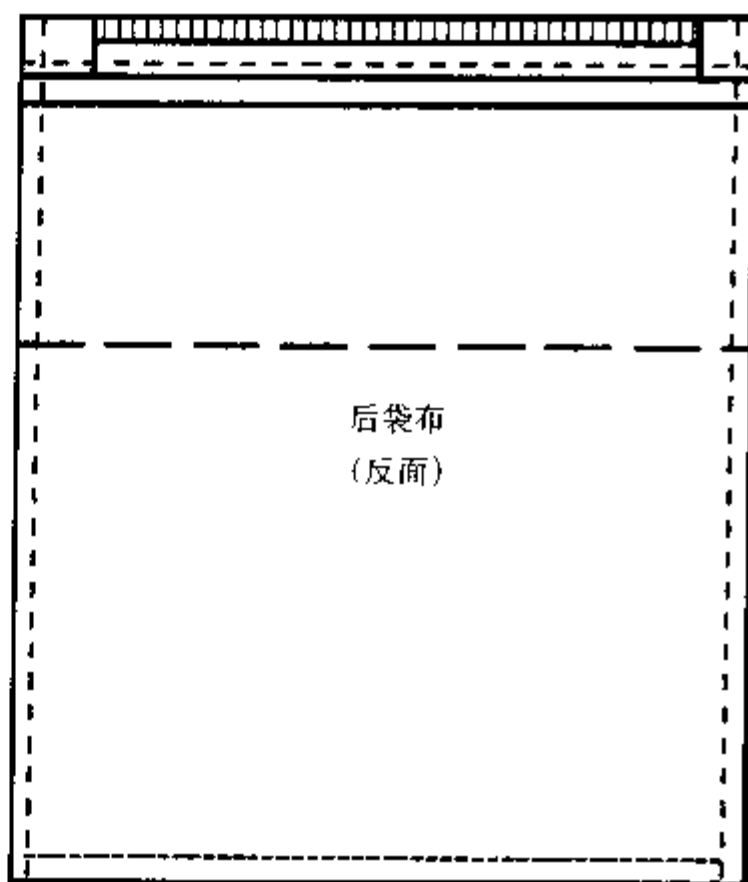

⑧缝合袋布底角

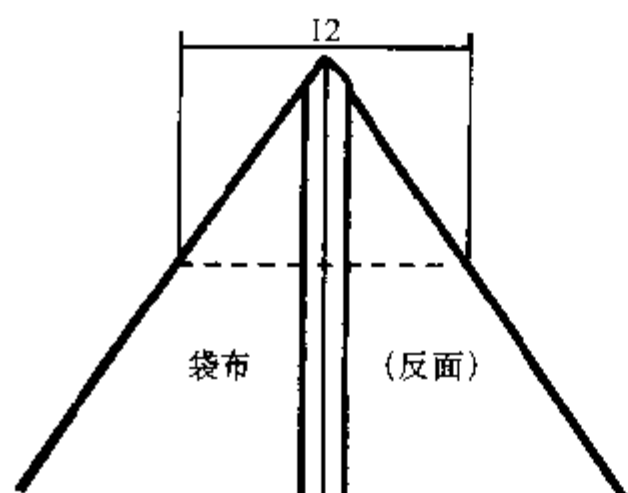

⑩缉缝背带



⑨缝合袋口吊环

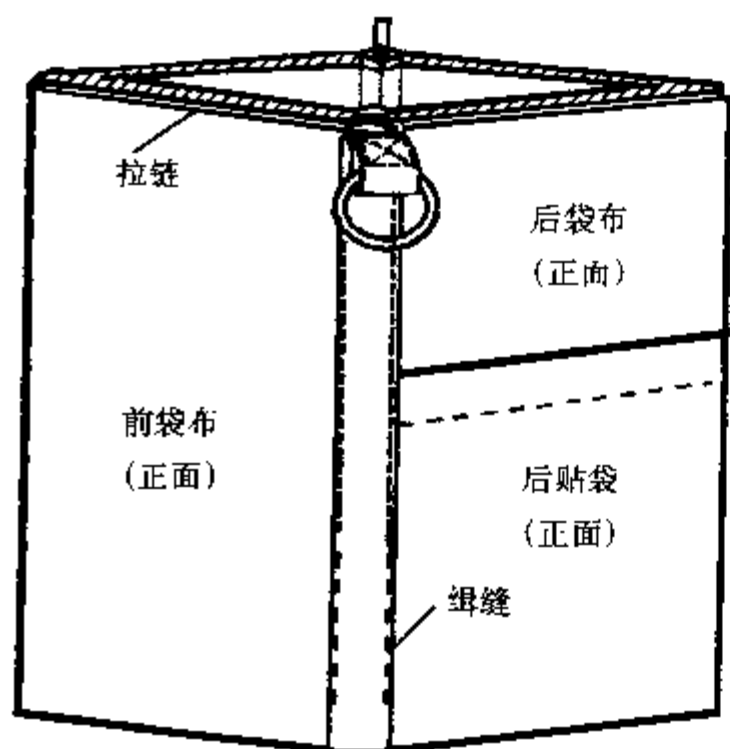

⑪缝合背带

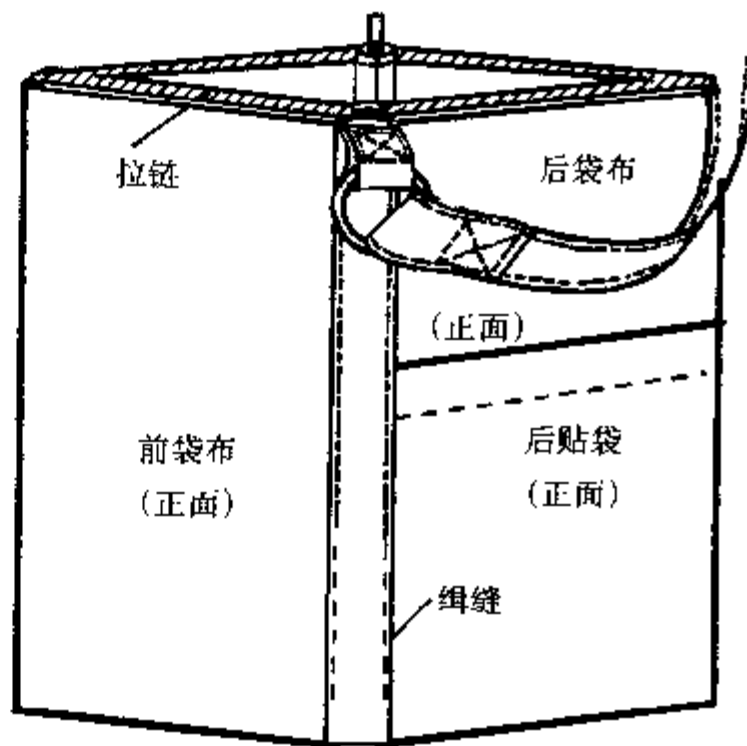

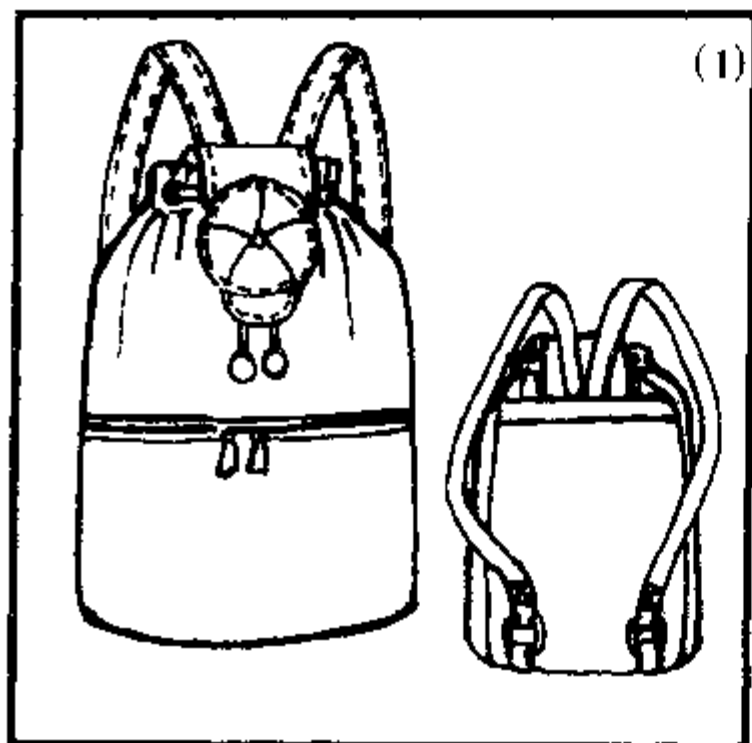

● 郊游双肩背袋

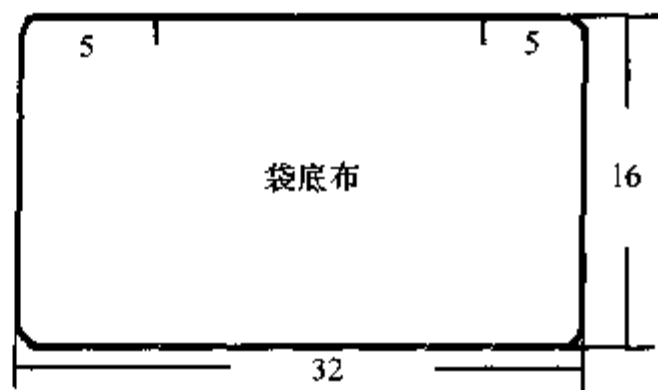
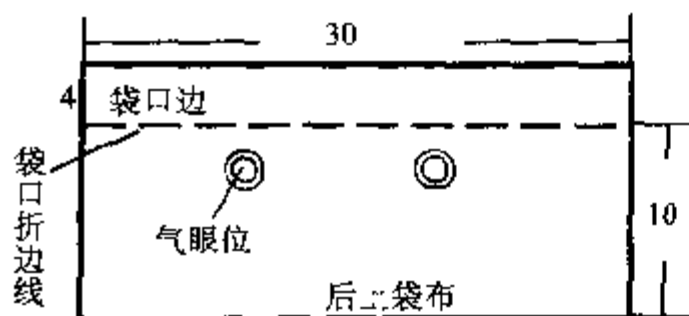
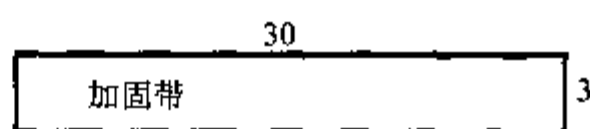
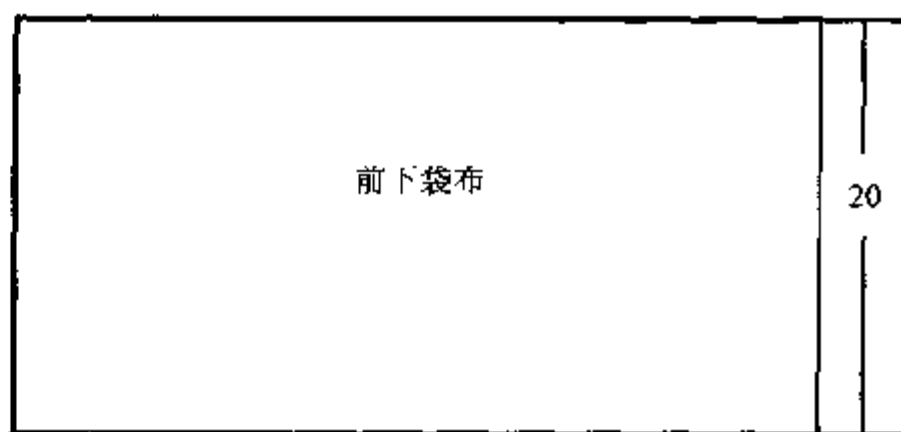
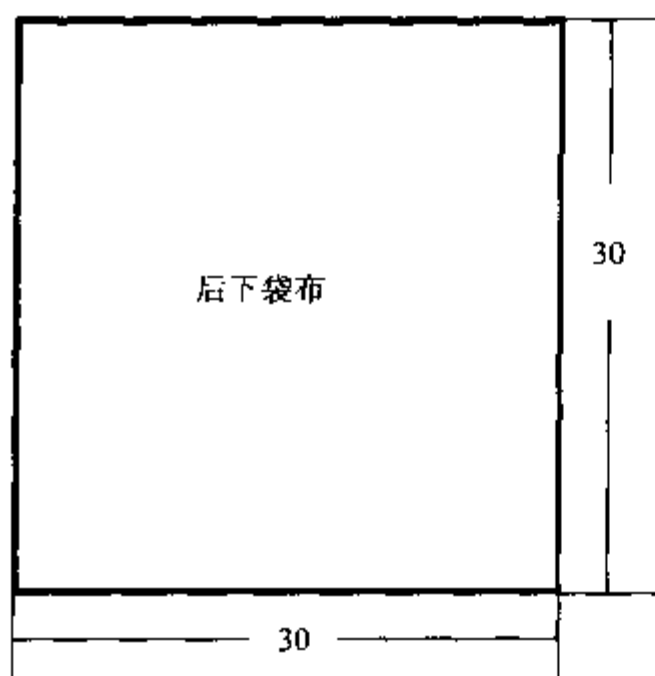
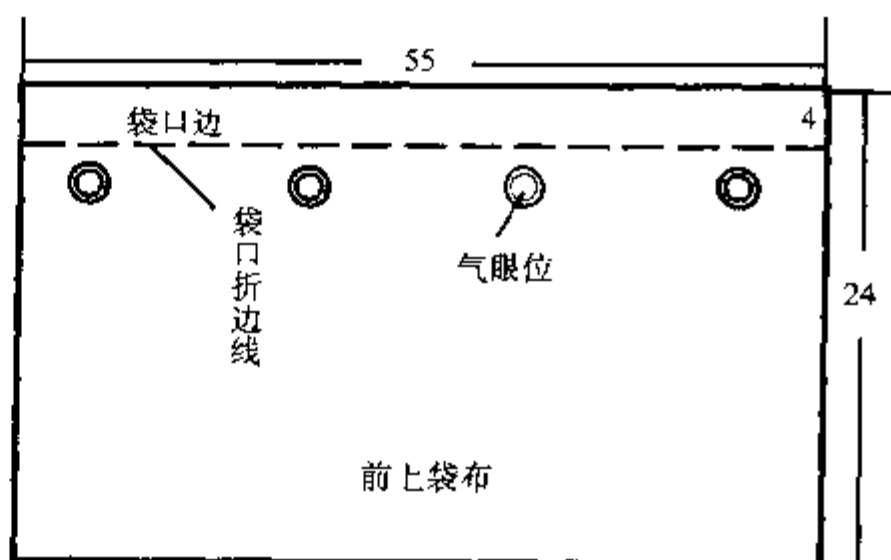

70

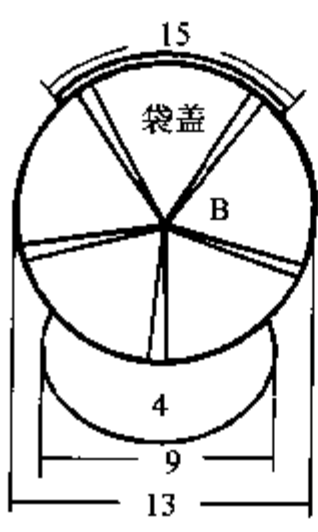
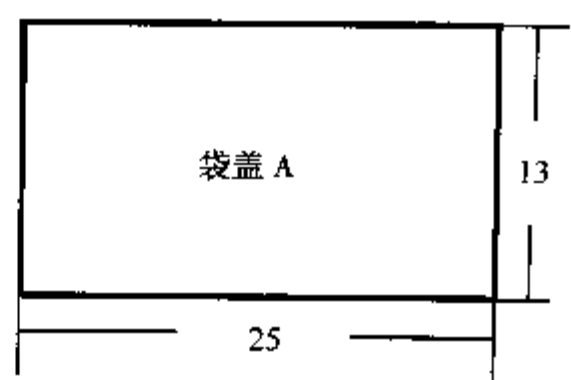
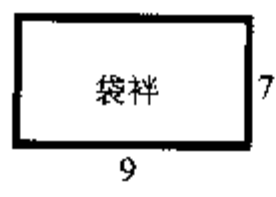
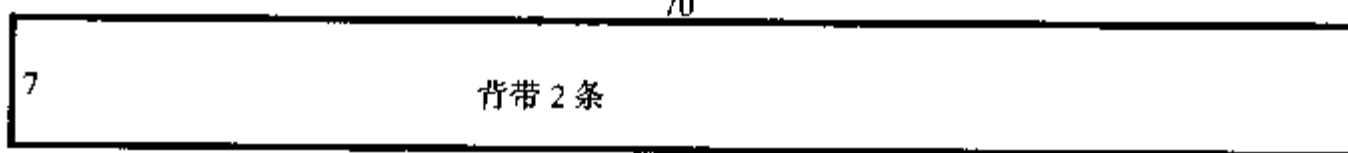

①折边

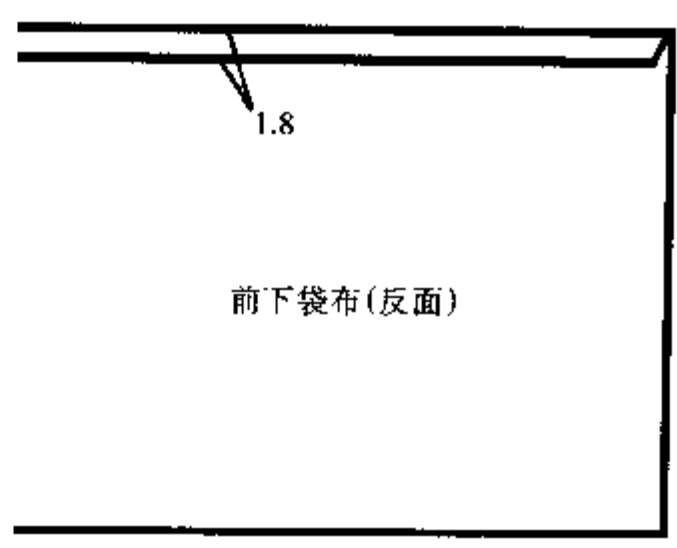

②将前下袋里布夹在前上袋布的折边中

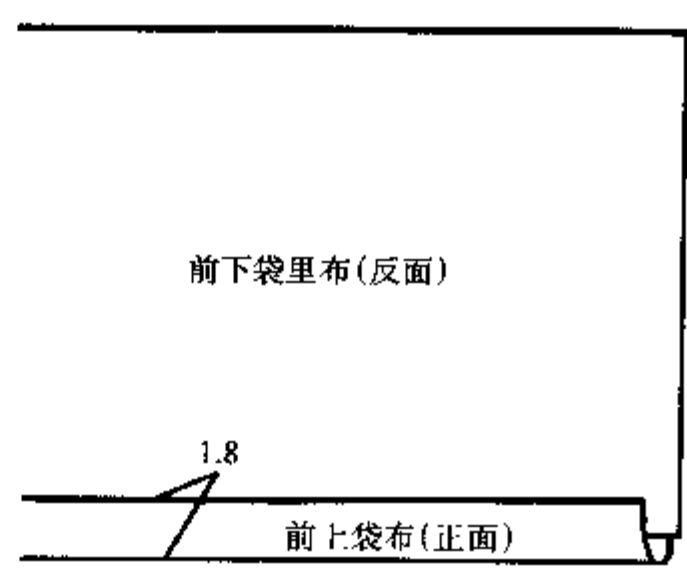
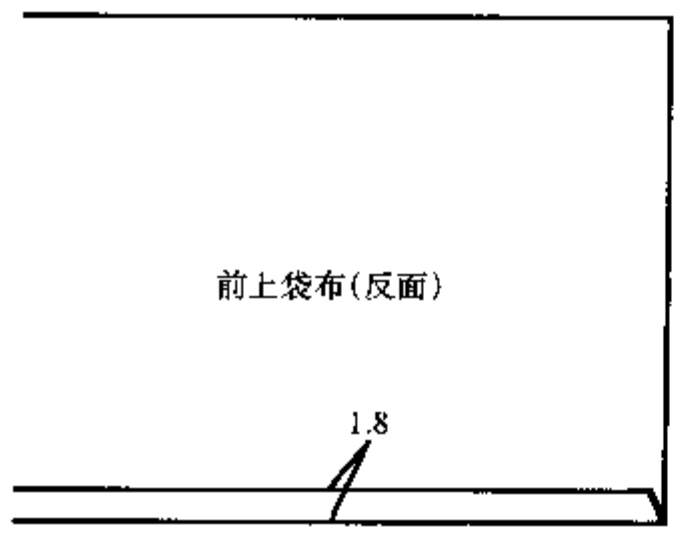

③压缝拉链

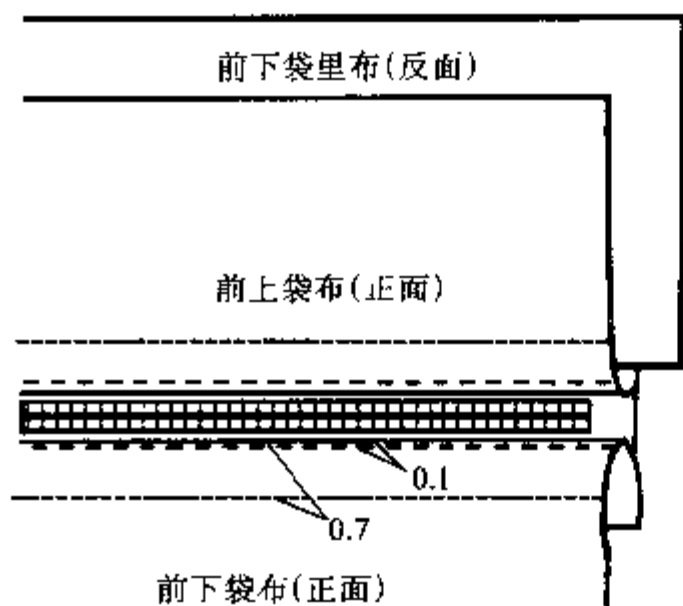

⑤制作袋盖小装饰

a. 缝合帽瓣

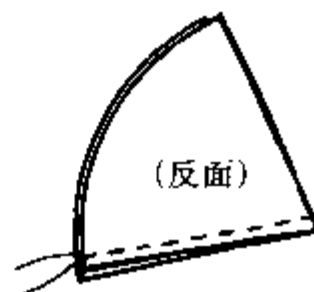

b. 帽瓣(反面)

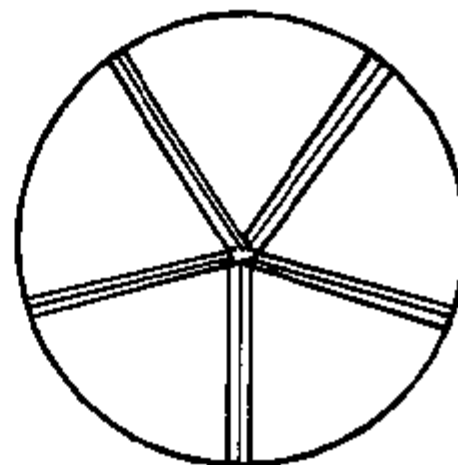

c. 帽瓣(正面)

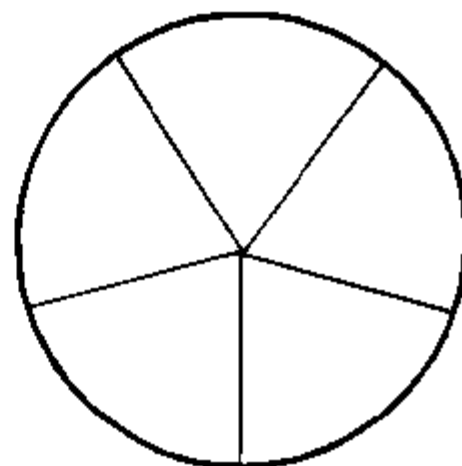

④将前下袋里布拉至底边

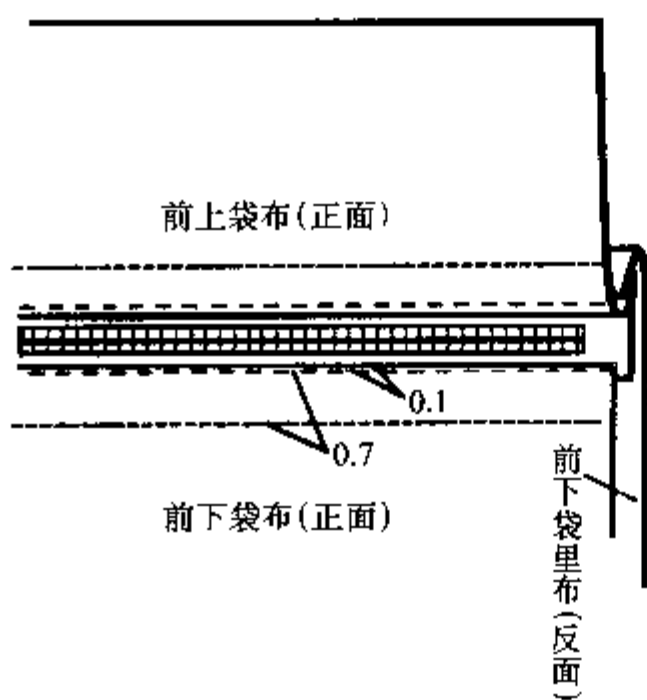

d. 缝合帽檐



e. 将帽檐翻至正面缉明线



f. 折边

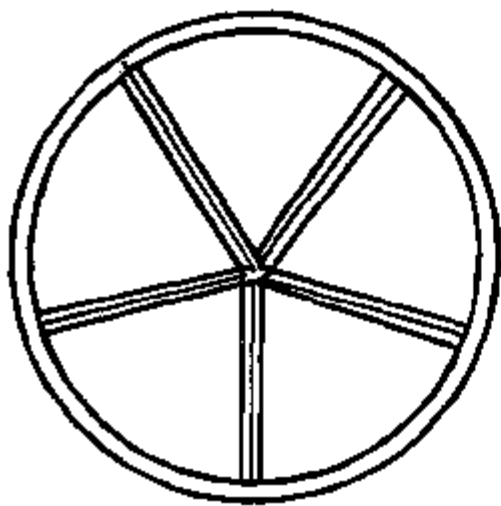

h. 缝合袋口封盖

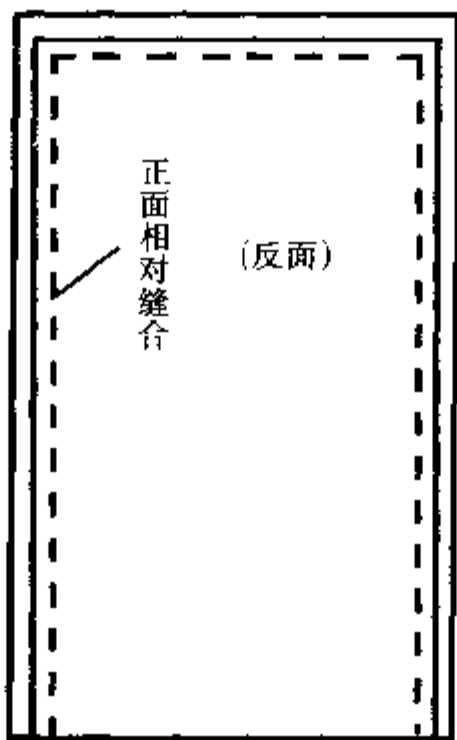

i. 缉明线

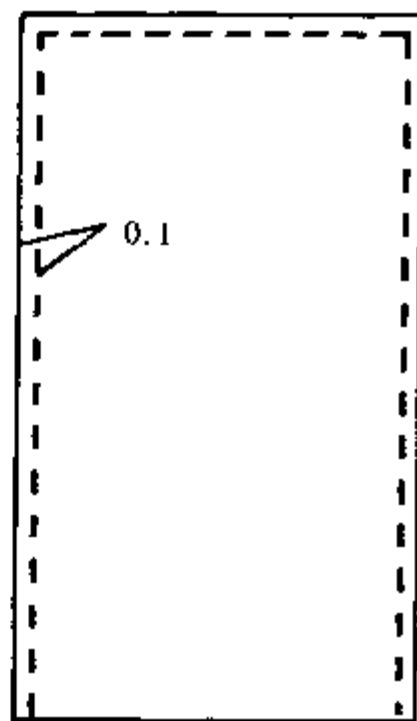

g. 压缝拉链的一边

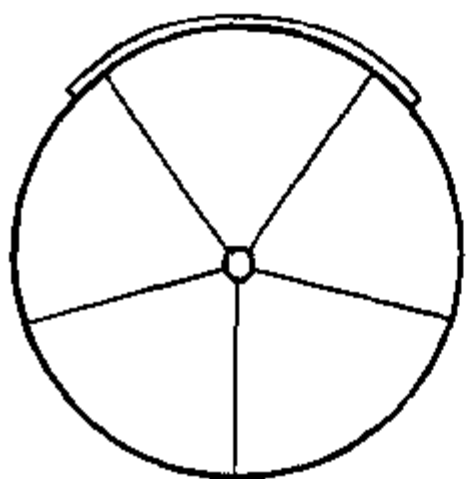

j. 缝合袋盖小装饰帽

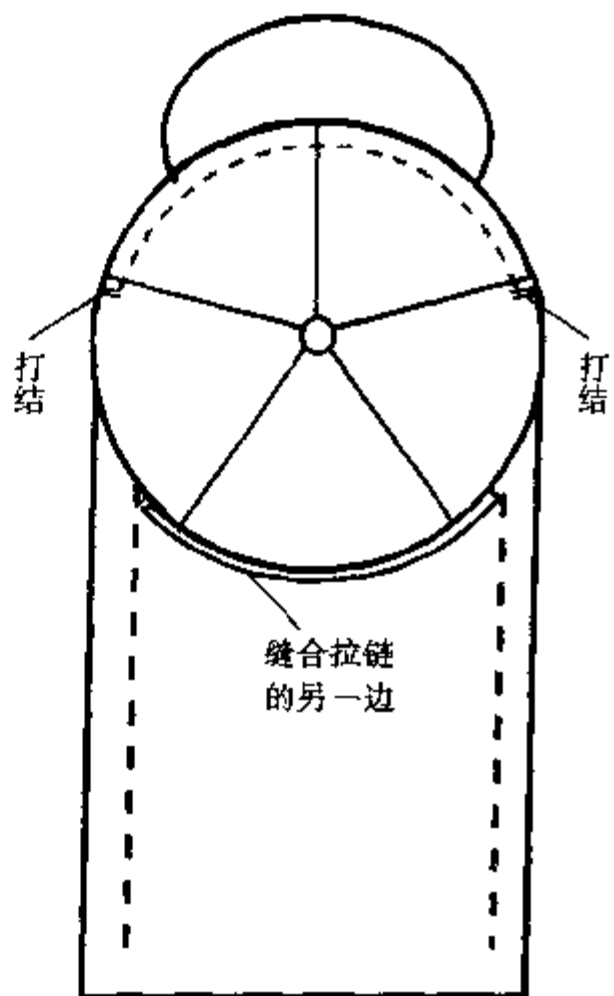

⑥ 压缝背带及袋盖

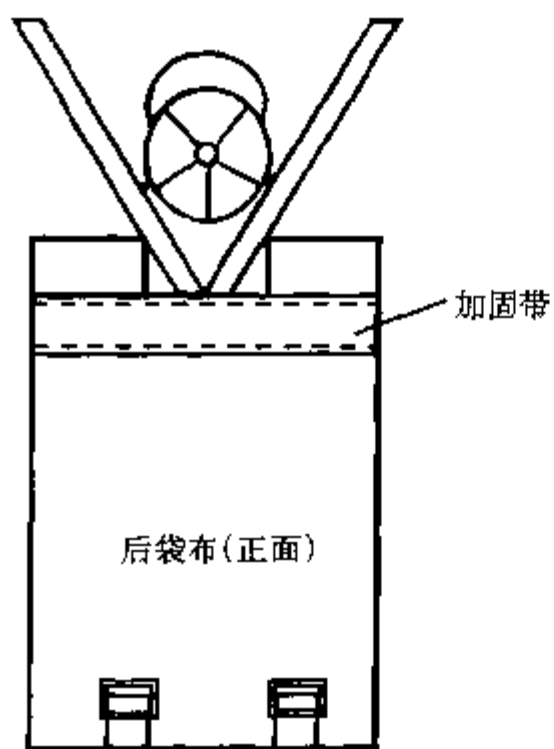

⑦缝合前、后袋布

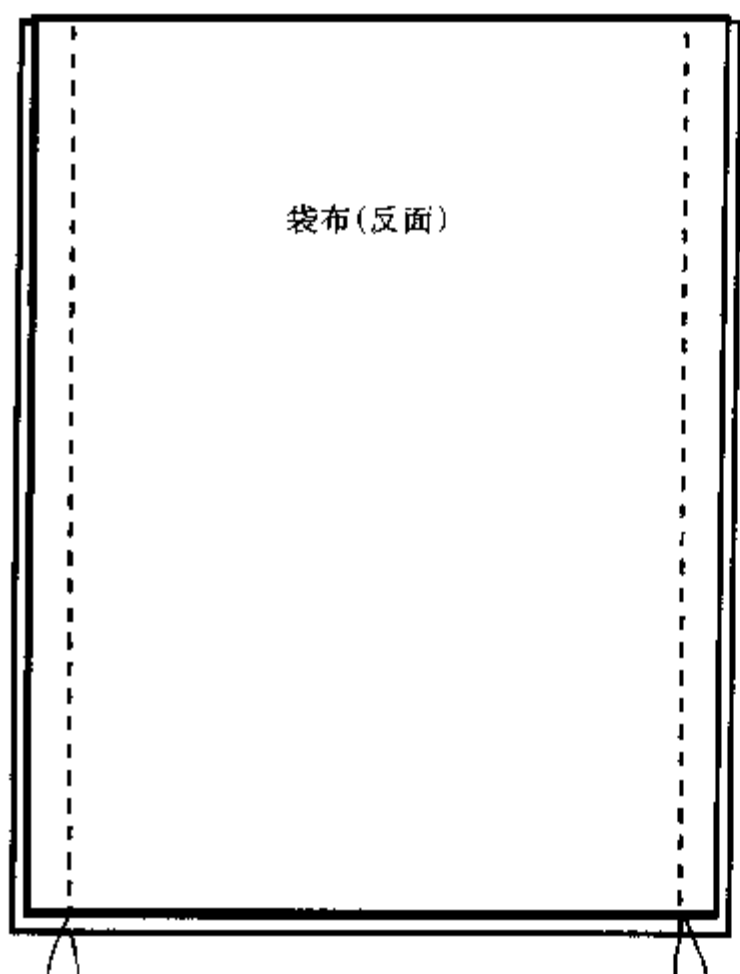

⑩钉气眼

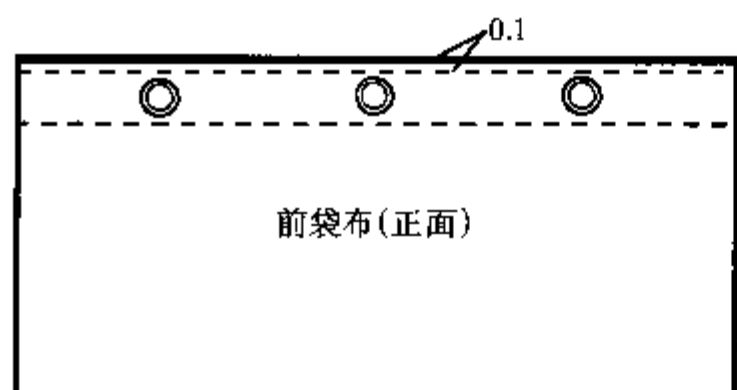

⑧折边

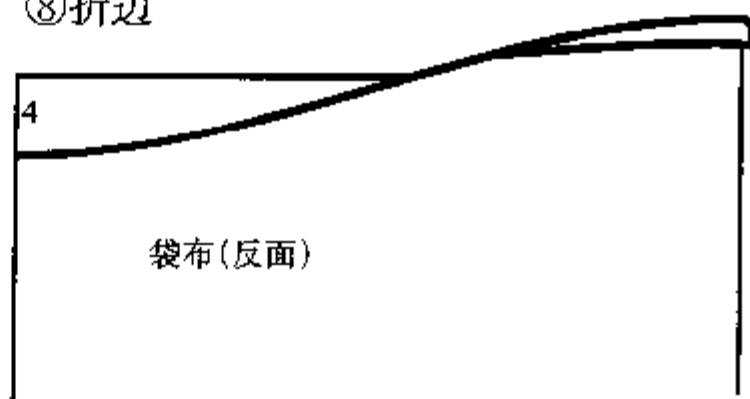

⑨缉明线

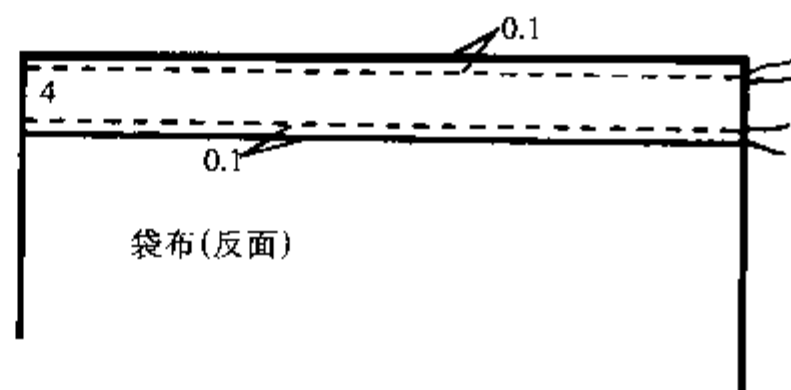

⑪缝合袋底

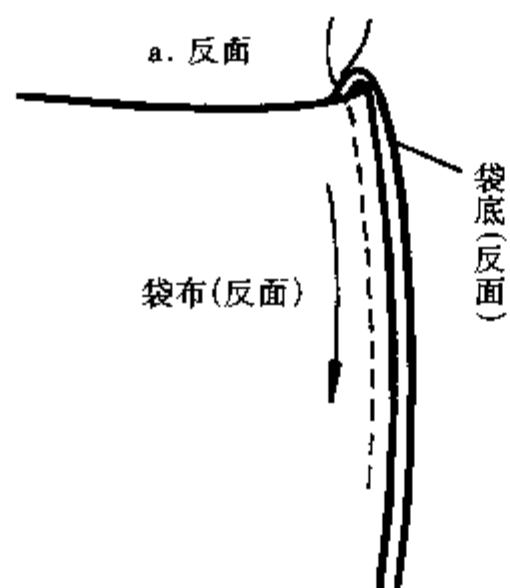

b. 正面

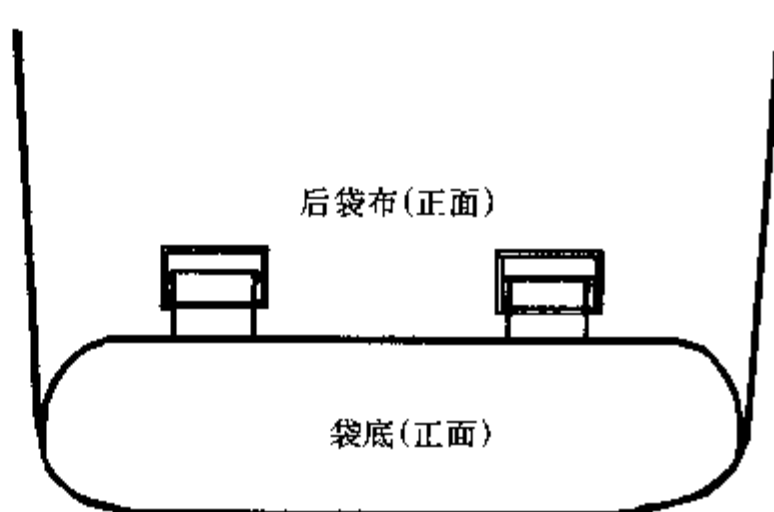

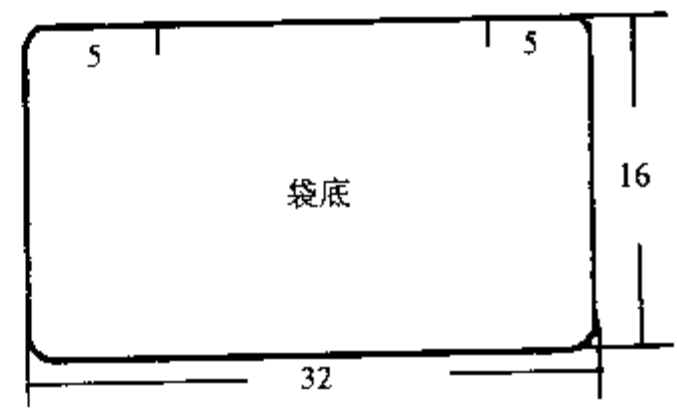
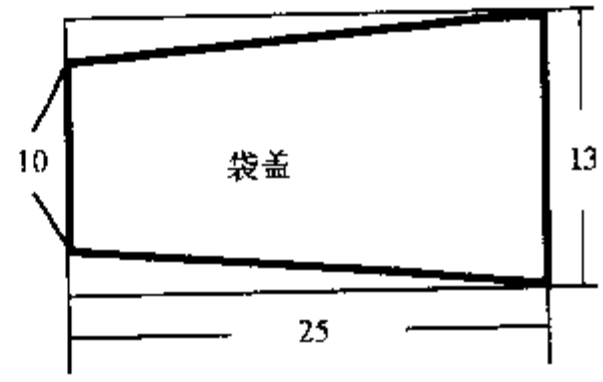
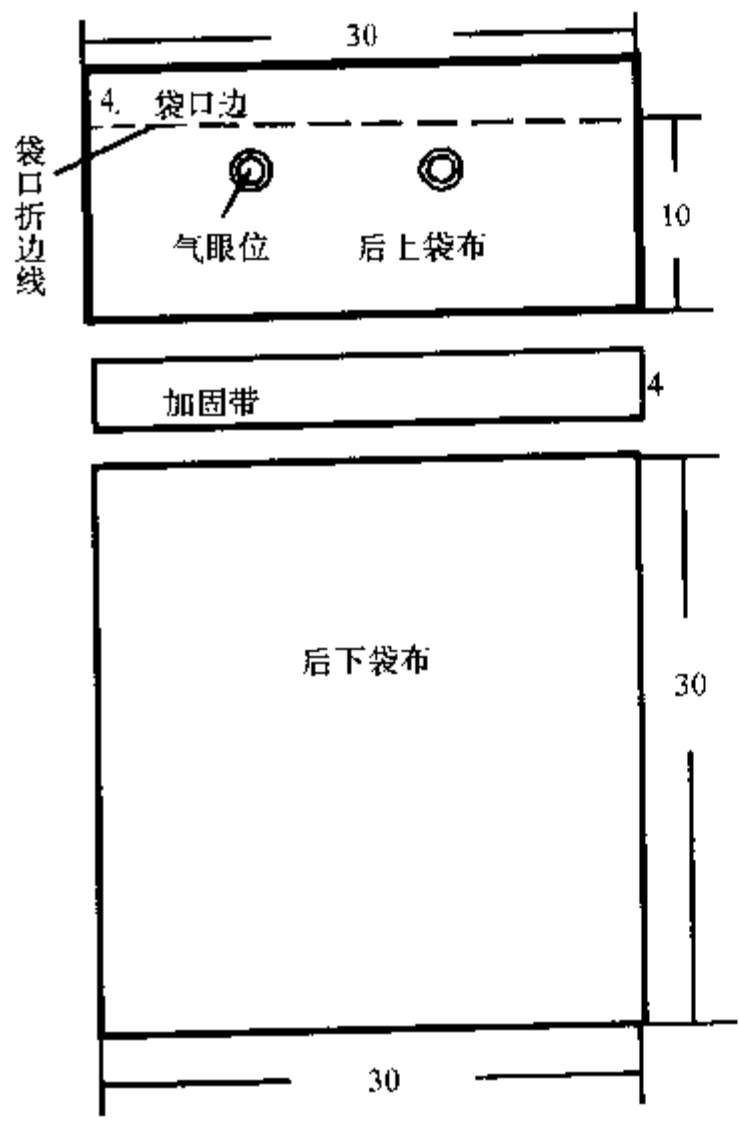
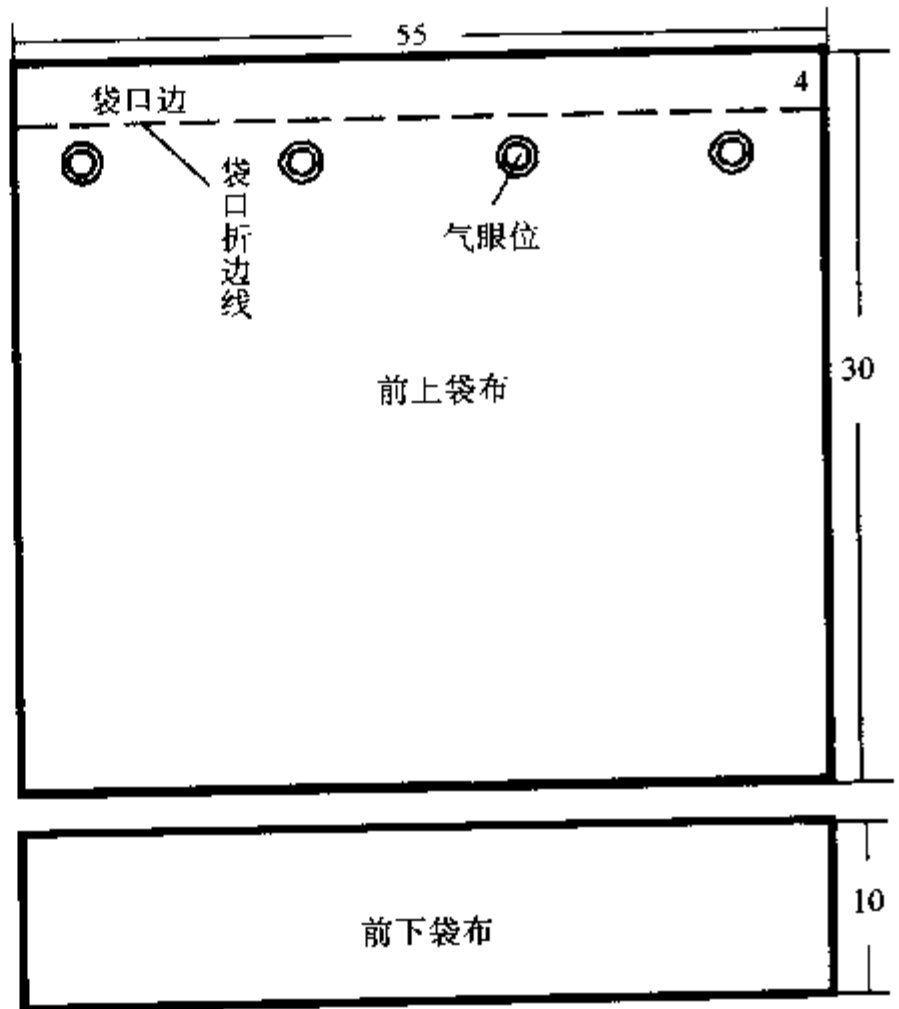
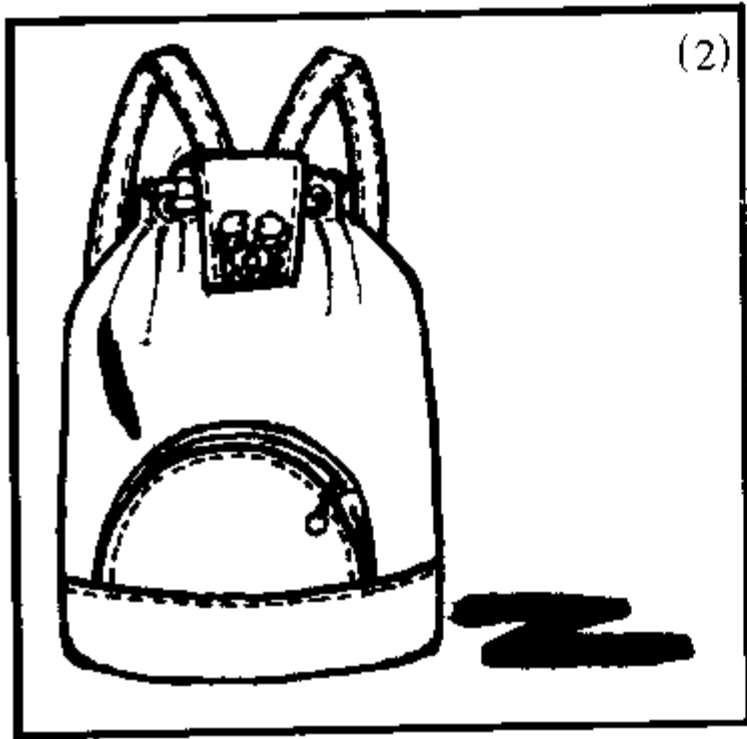

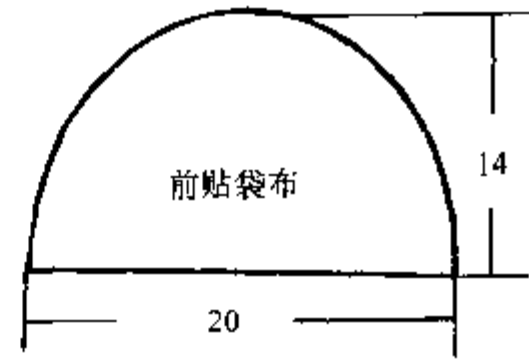
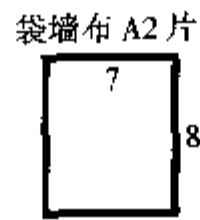
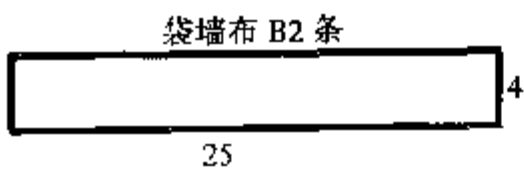
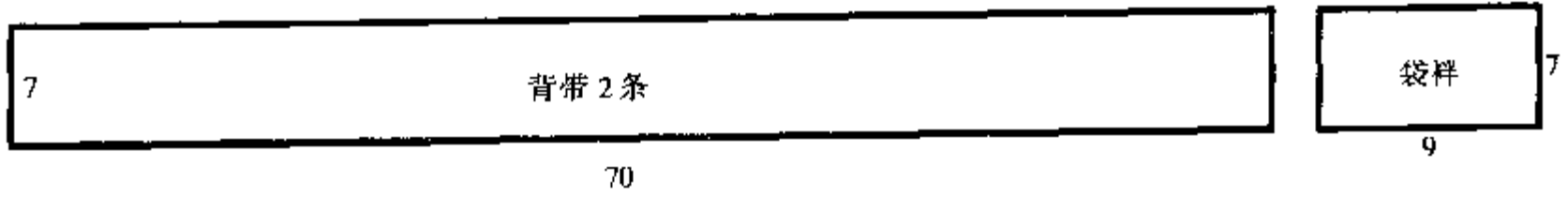

①折边

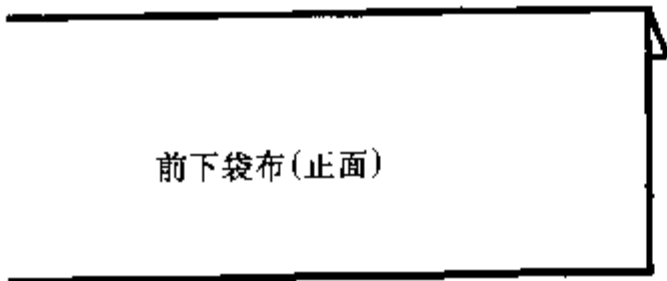
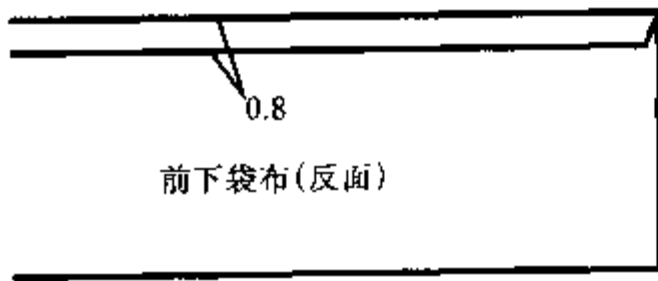

②制作前贴袋

a. 压缝拉链

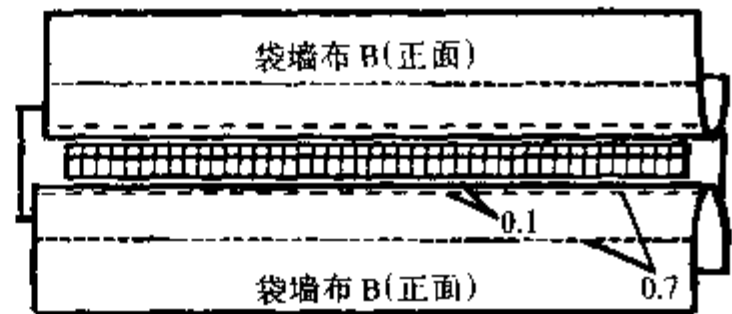

b. 缝合袋墙布 A

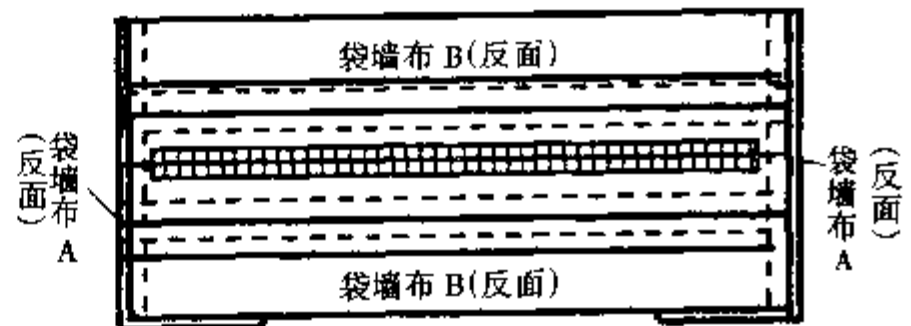

c. 拉链翻至正面

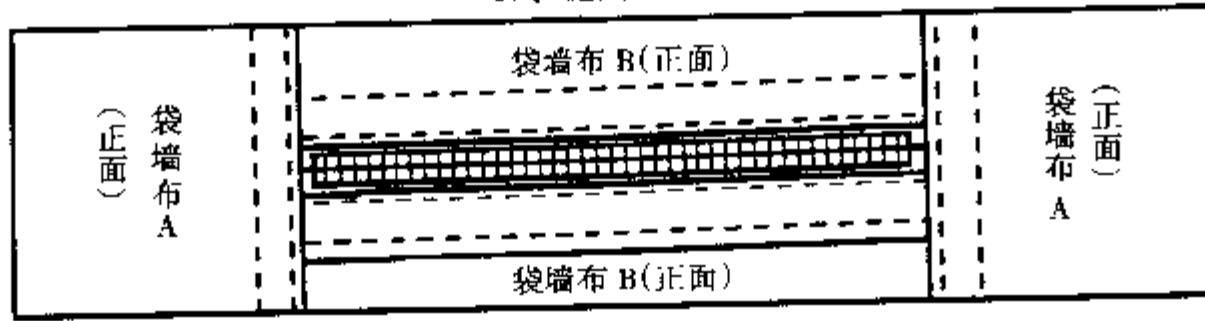

d. 前贴袋布与拉链缝合

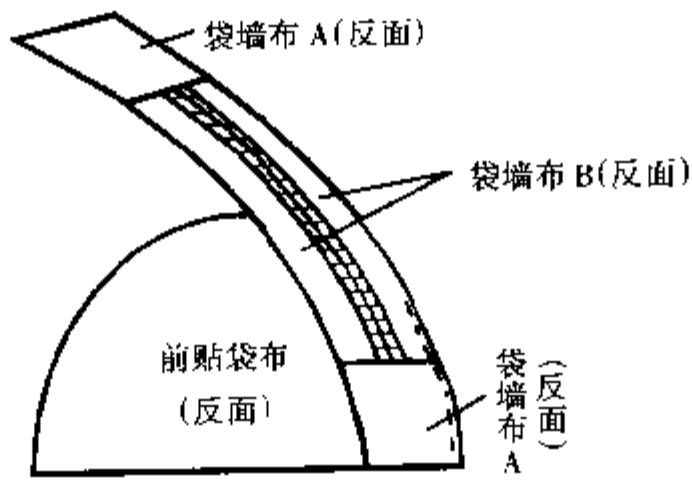

③ 前贴袋布与前上袋布对正

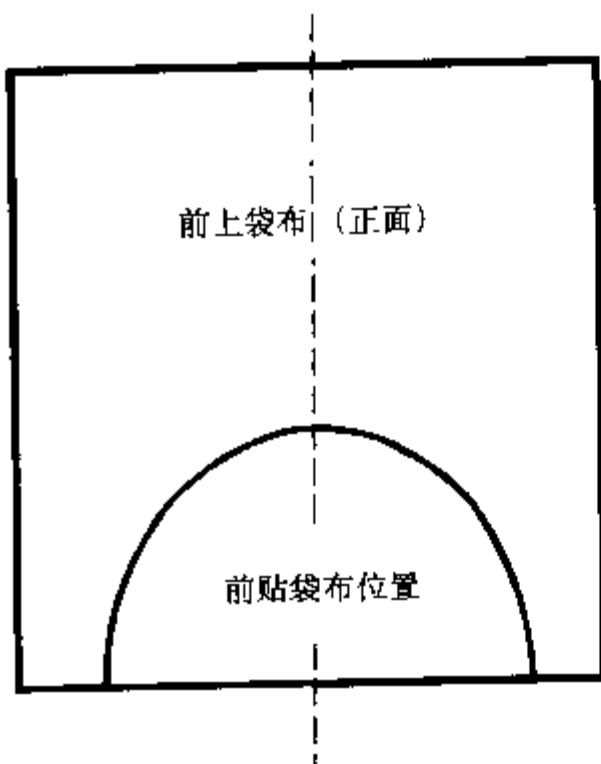

④ 前贴袋布与前上袋布缝合

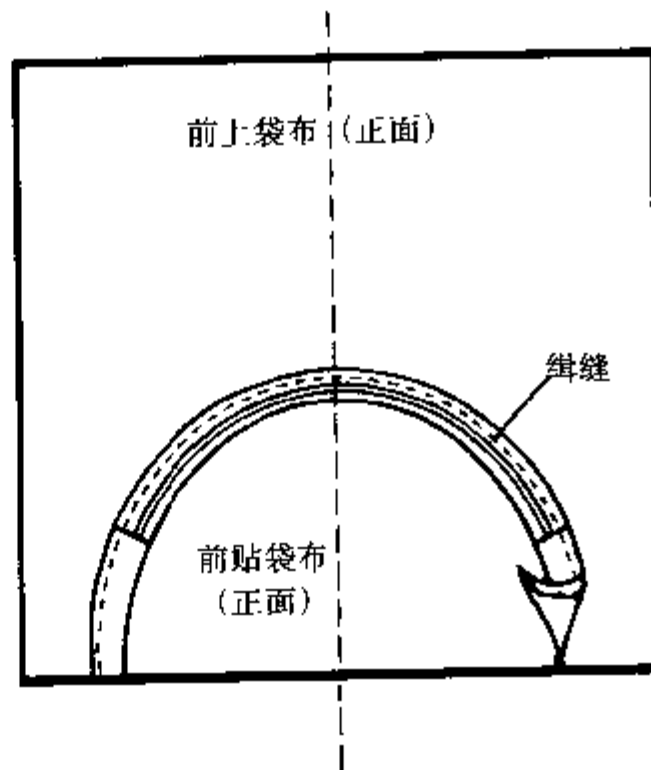

⑤与前下袋布缝合

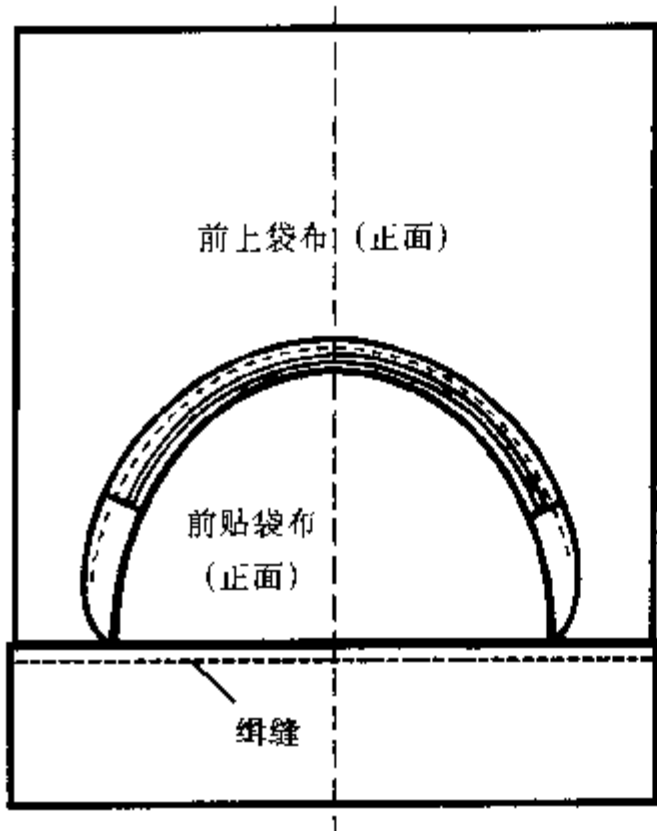

⑥制作袋盖装饰

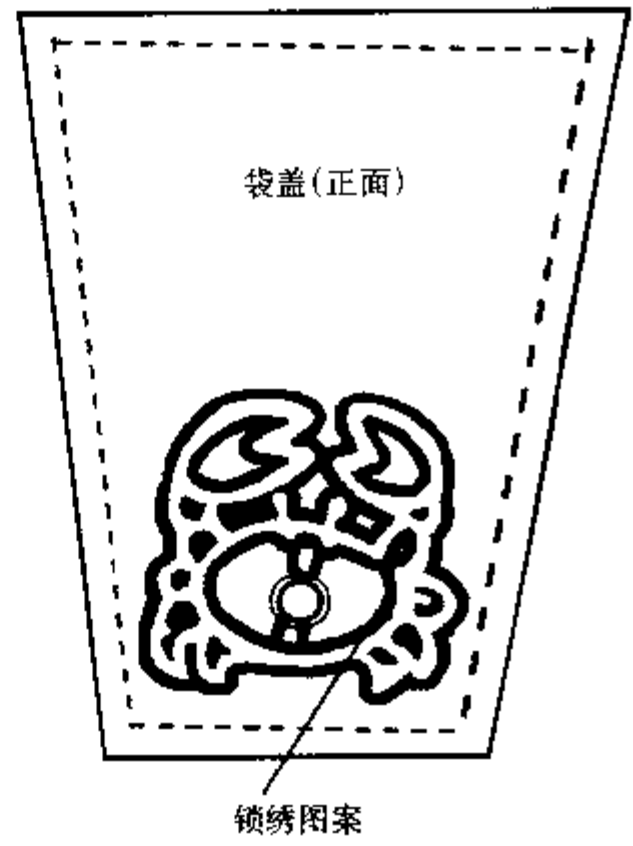

⑦压缝背带及袋盖

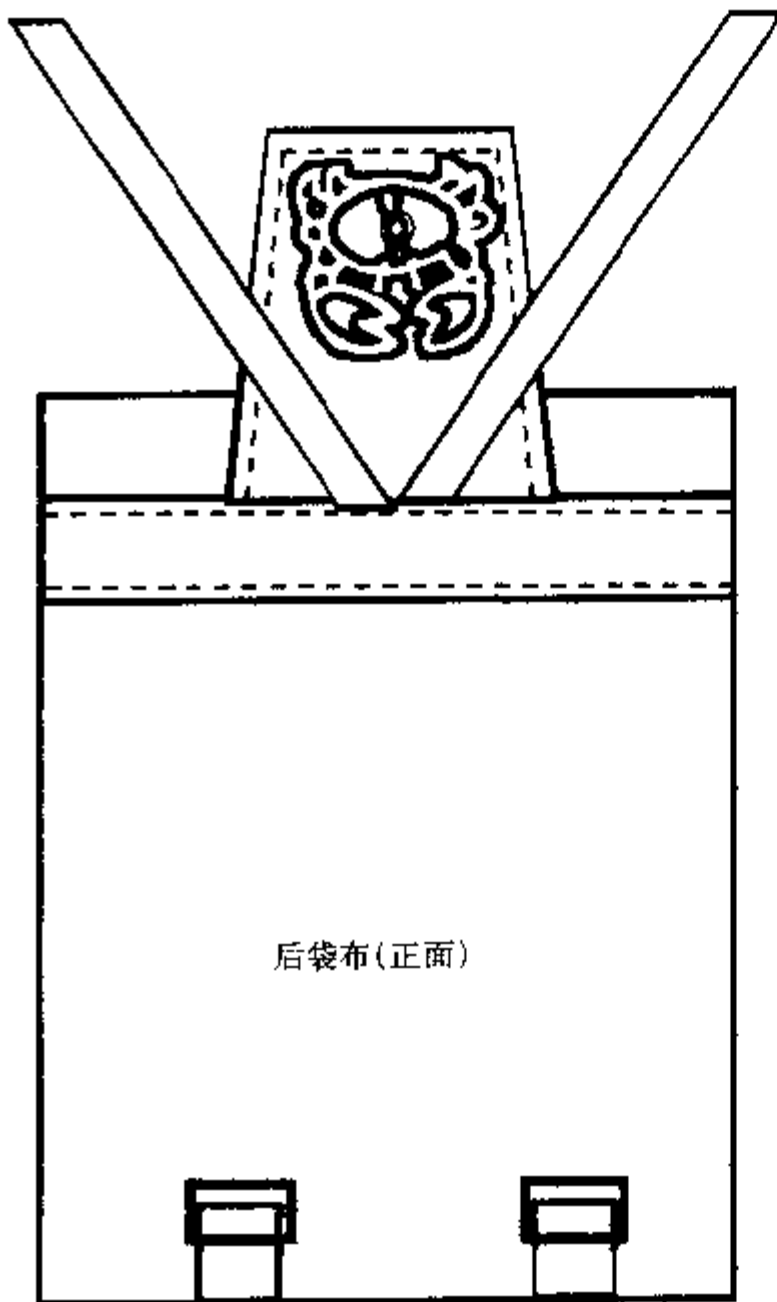

锁绣图案

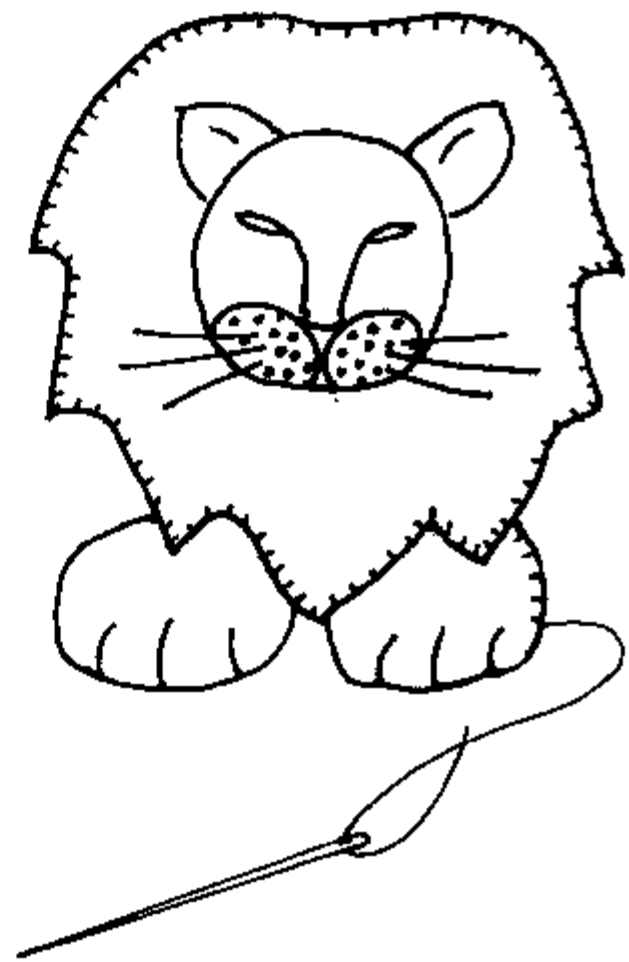

⑧缝合前、后袋布

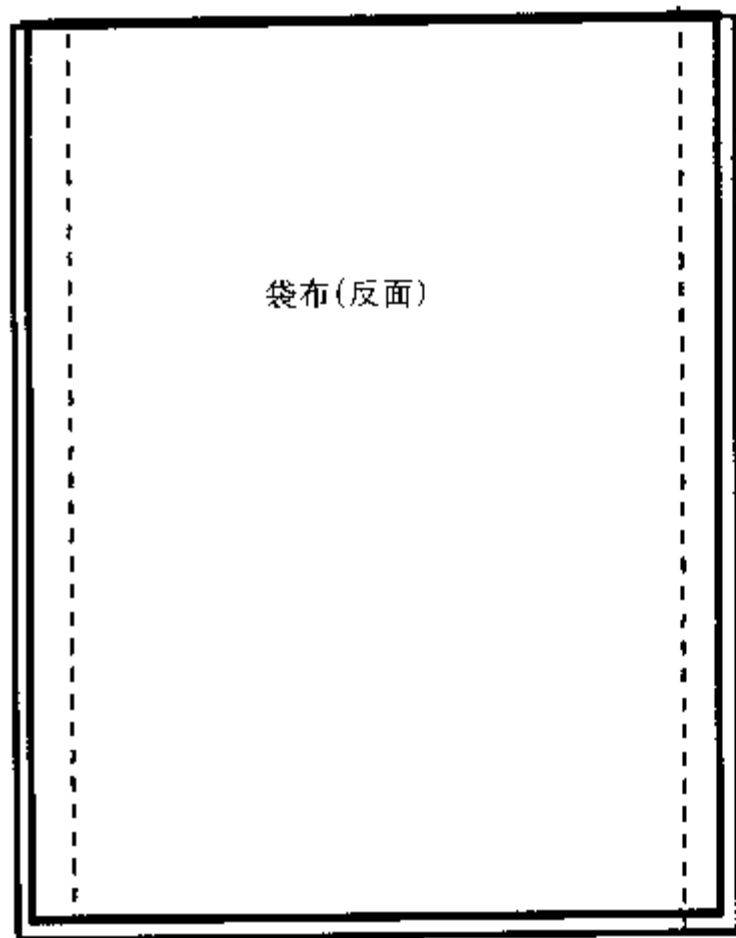

⑨折边

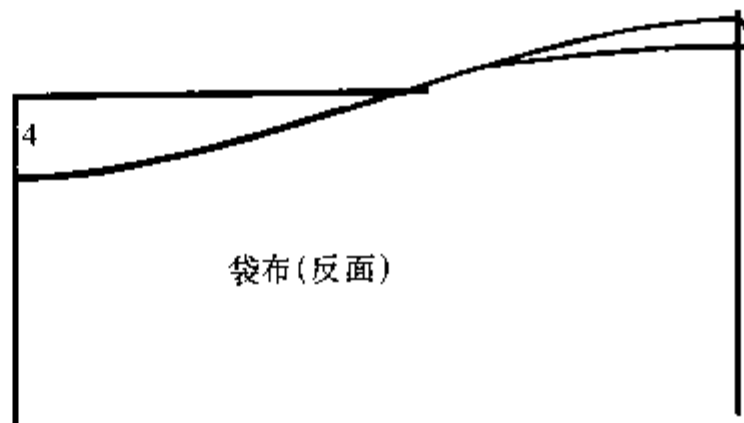

⑩缉明线

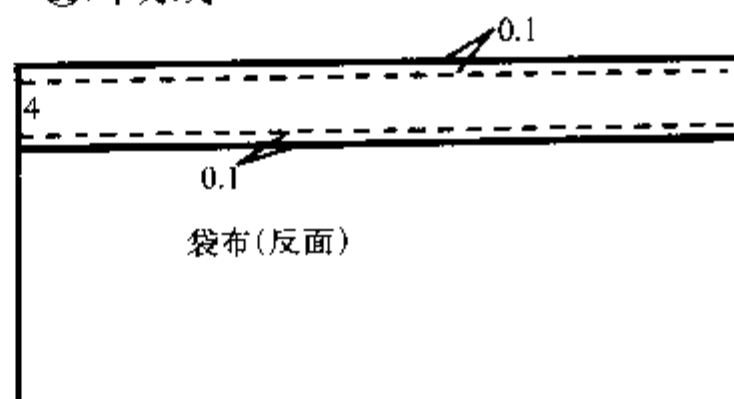

⑪钉气眼

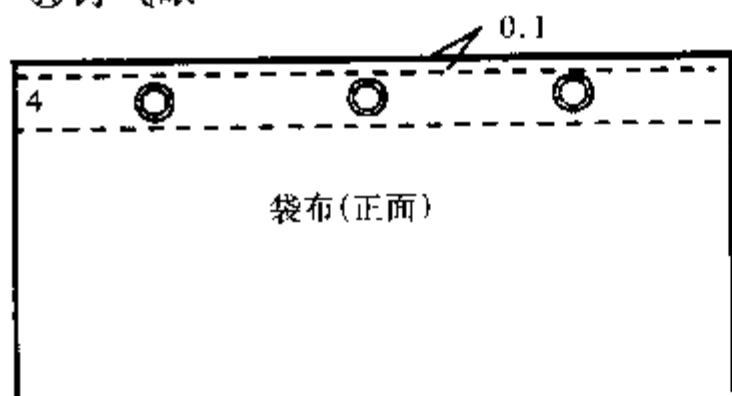

⑫缝合袋底

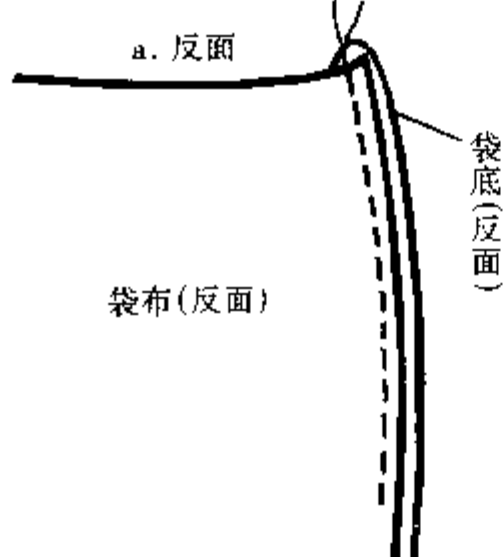

b. 正面

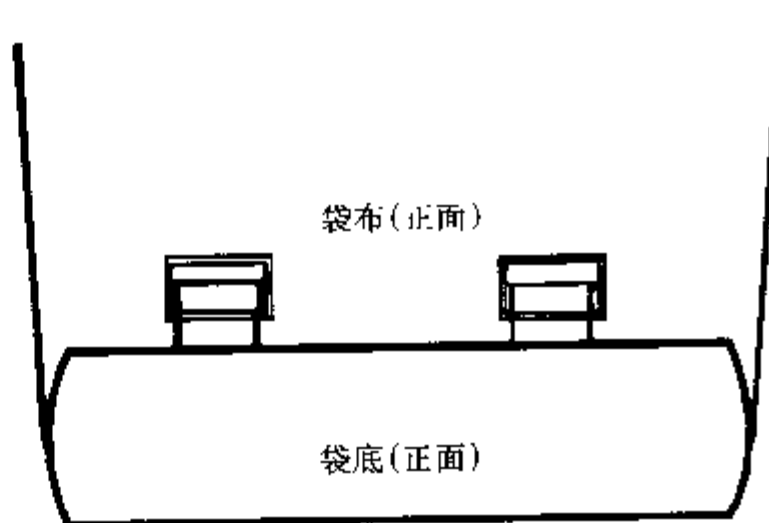

● 子母挂包

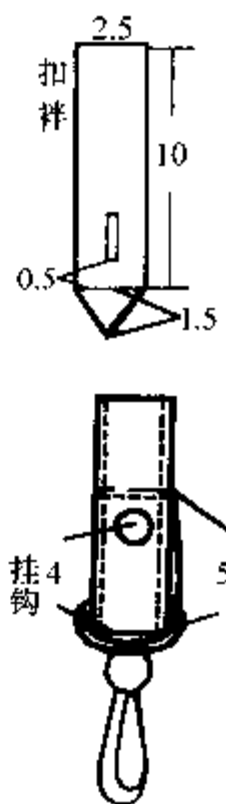
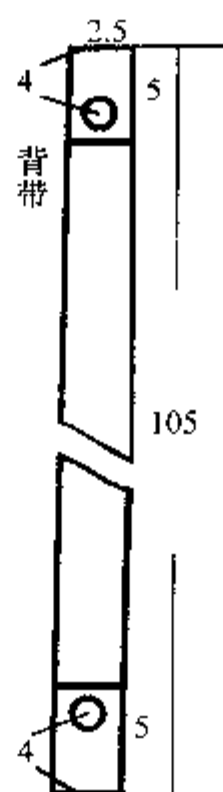
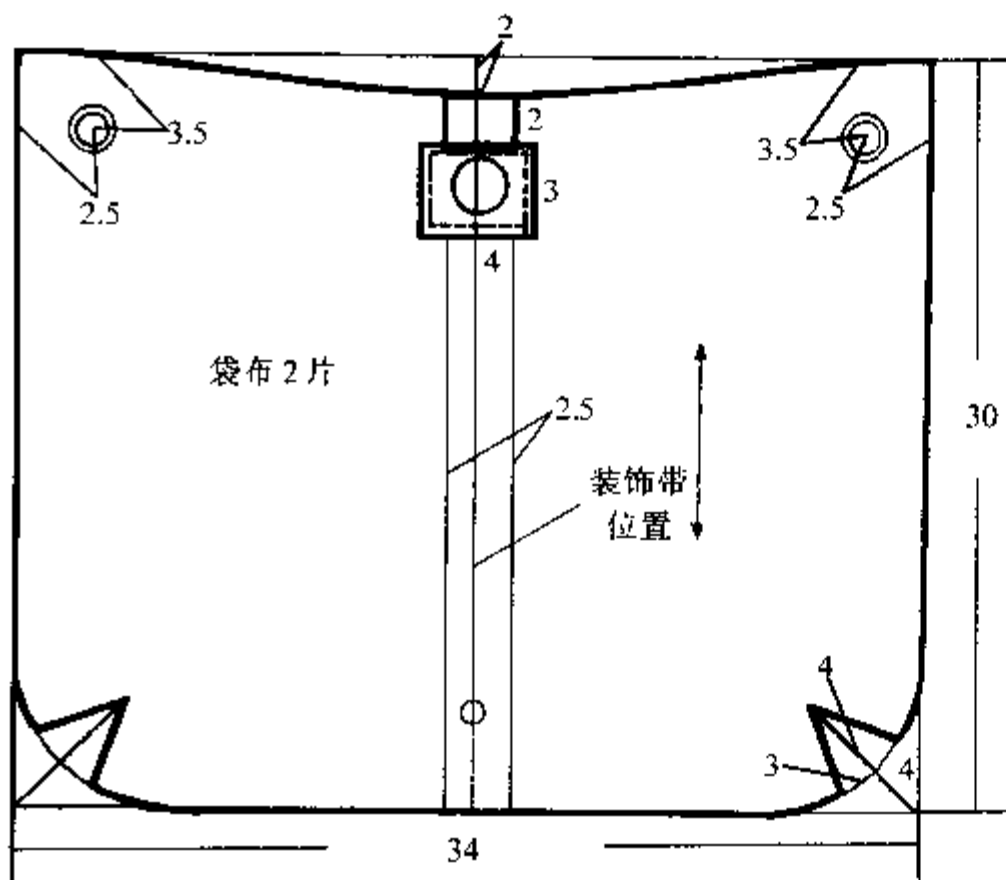
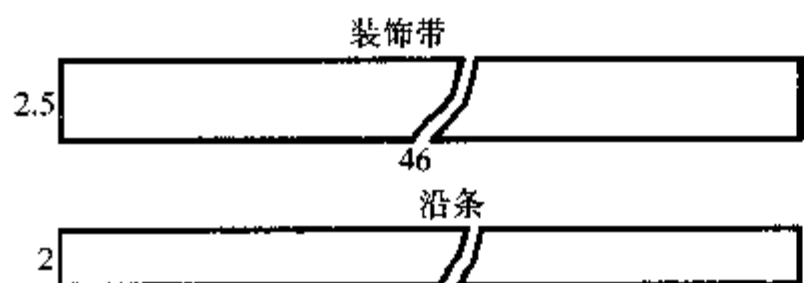
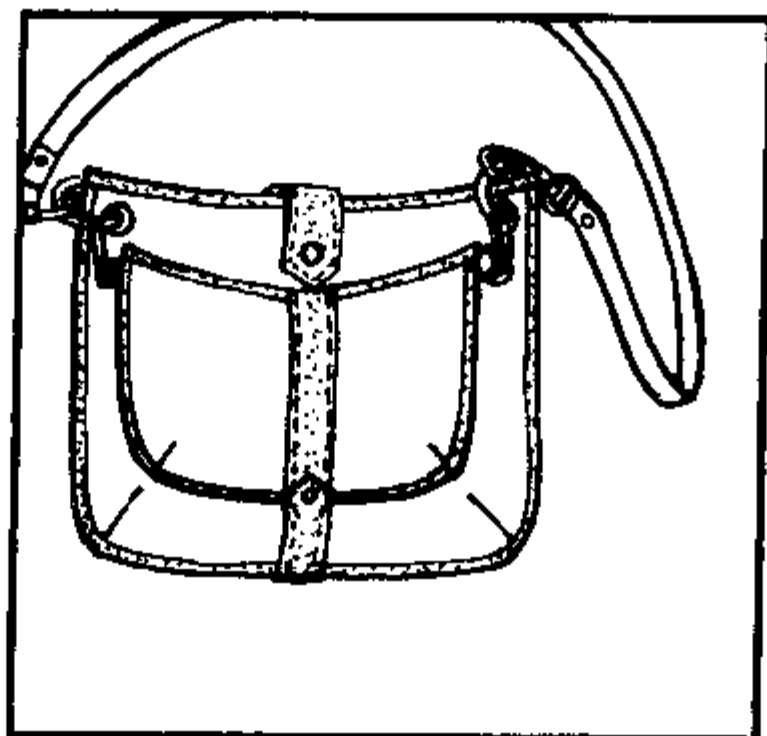
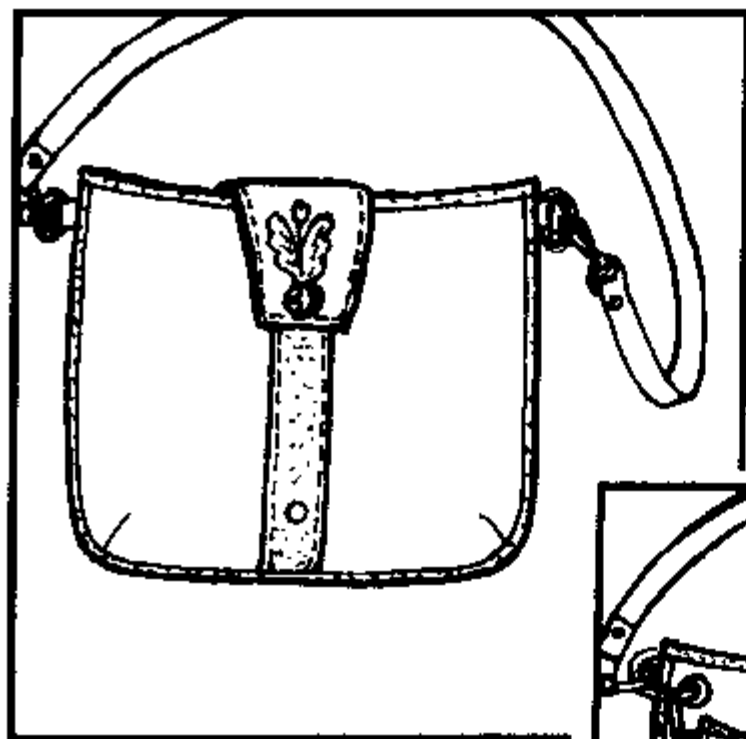

①袋底两角做省，并
将前、后袋布缝合

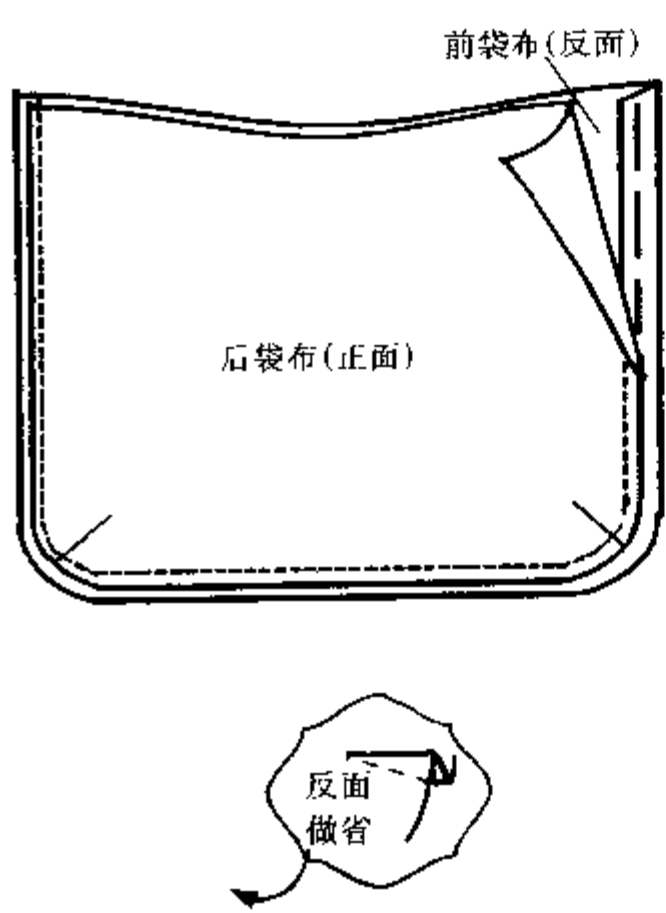

②袋口用沿条沿边

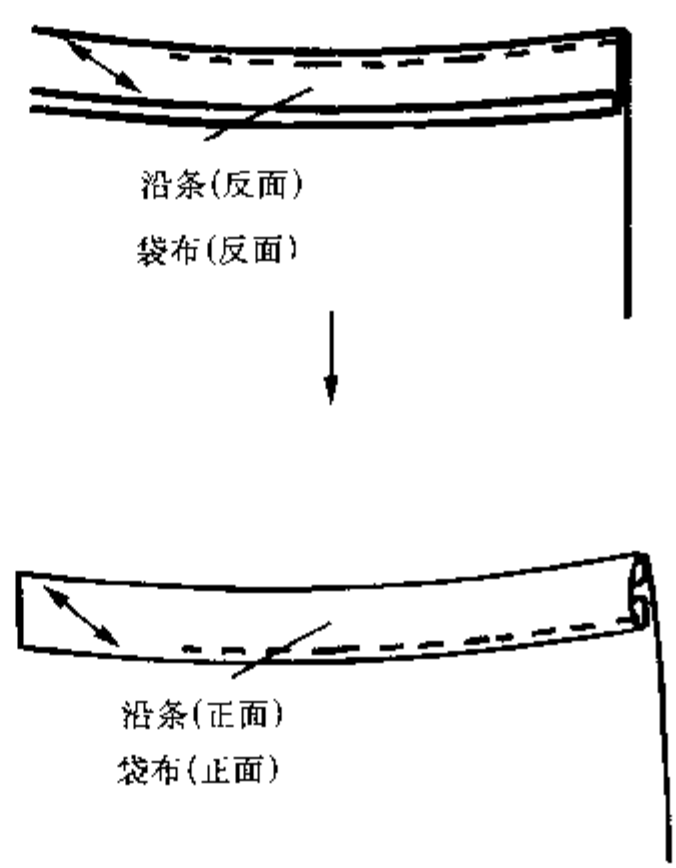

③用皮革做扣袢
缝于袋口中部

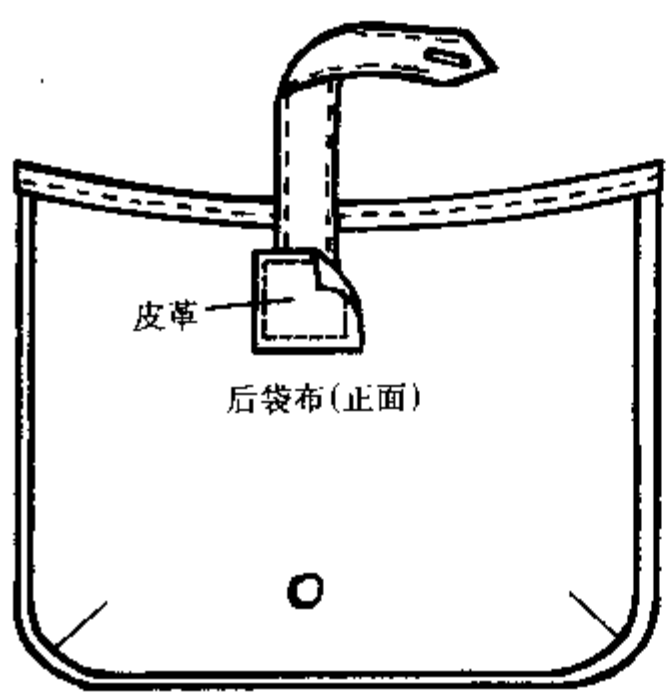

④钉组合扣并在袋口两
端钉气眼加金属环

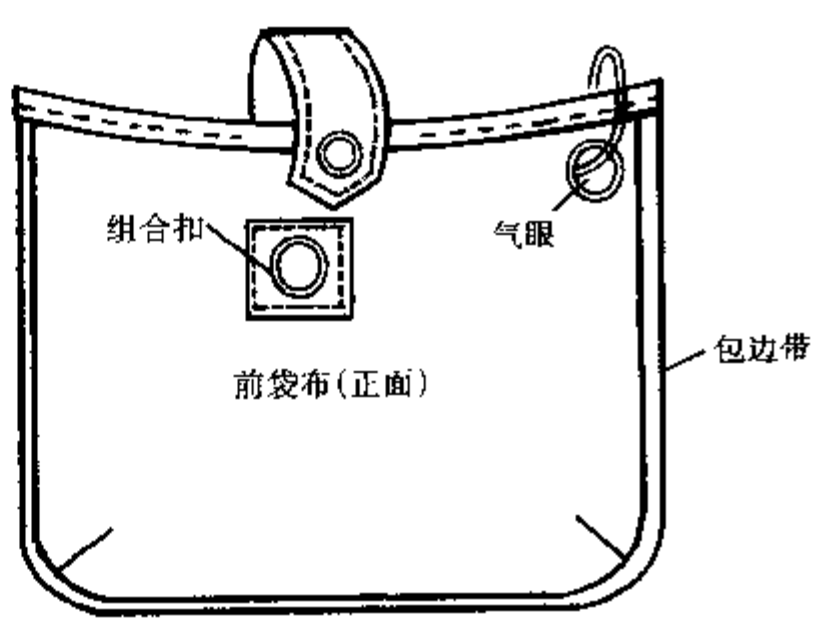

⑤制作小挂包

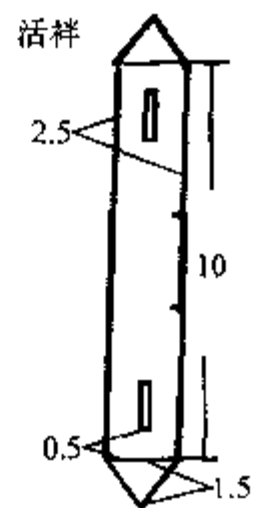
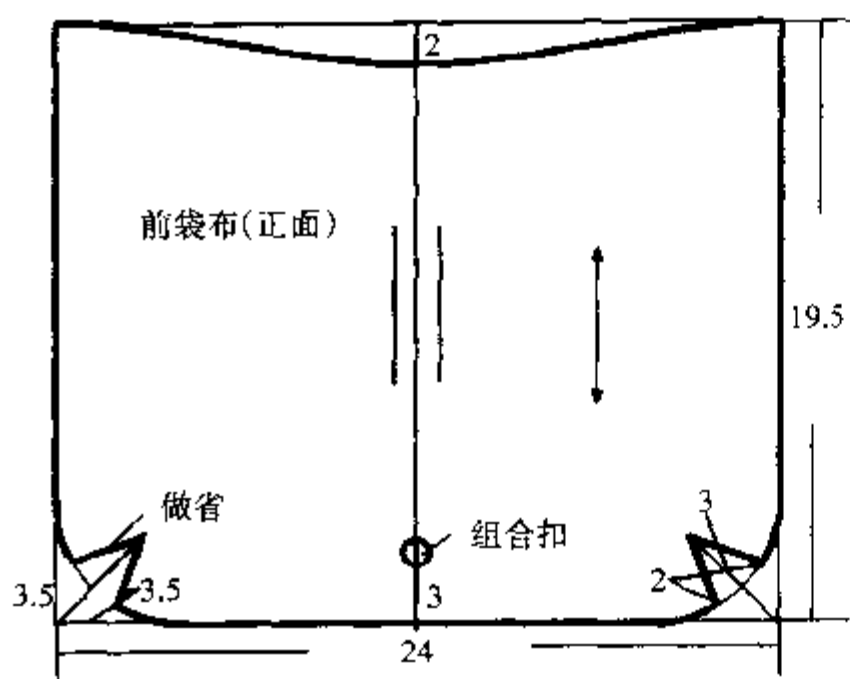

a. 袋布做省, 袋中线加装饰带

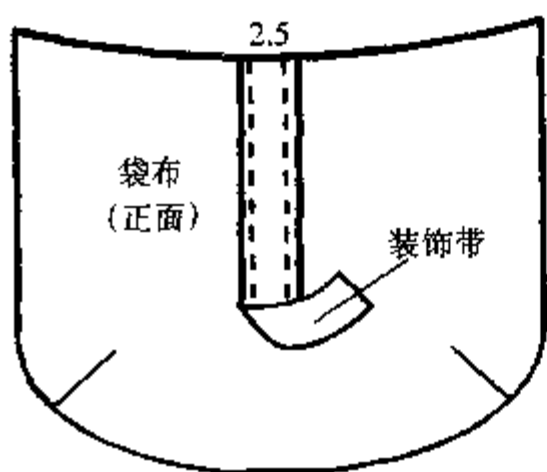
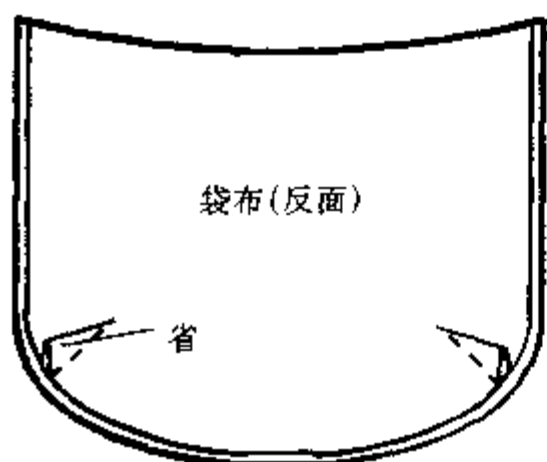

b. 缉拉链

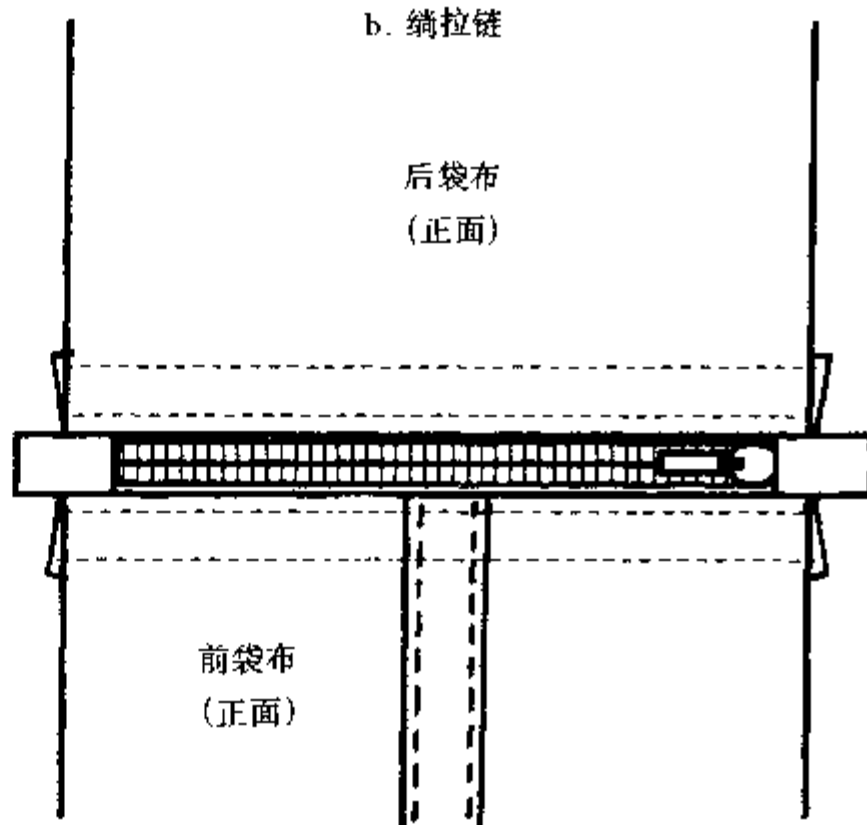

c. 用皮革制作挂钩固定样,缝合前、后袋布侧缝时放入袋口两侧上端

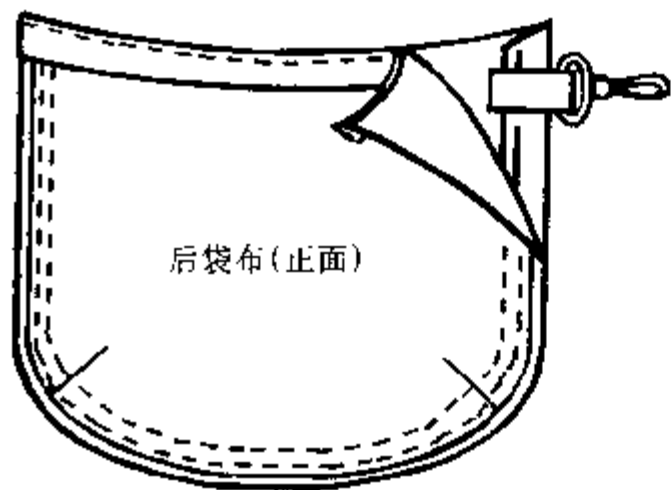

d. 钉组合扣

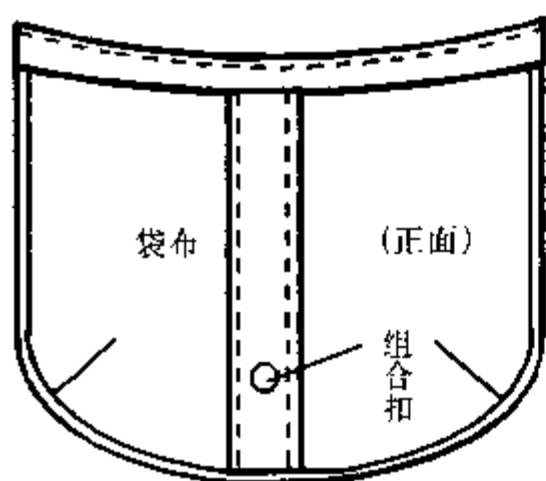

⑦各式扣袢

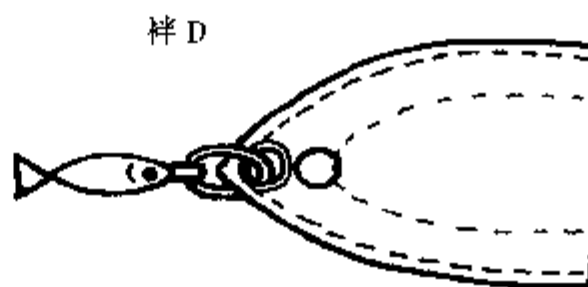
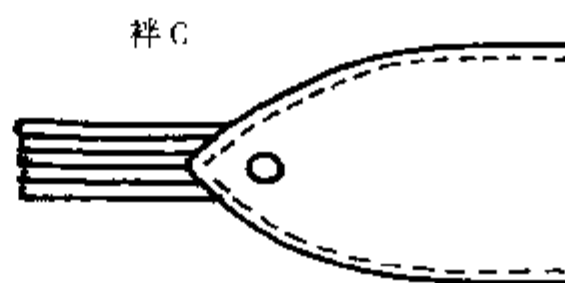
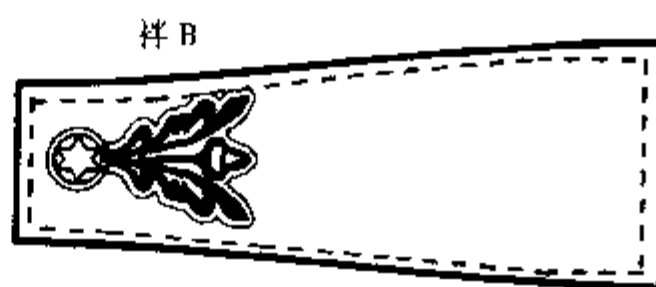
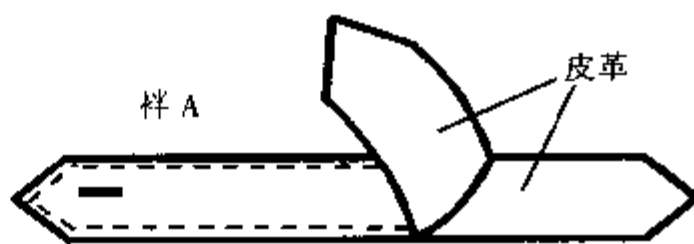

⑥制作背带

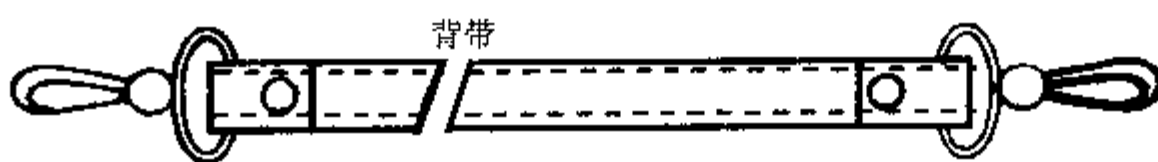

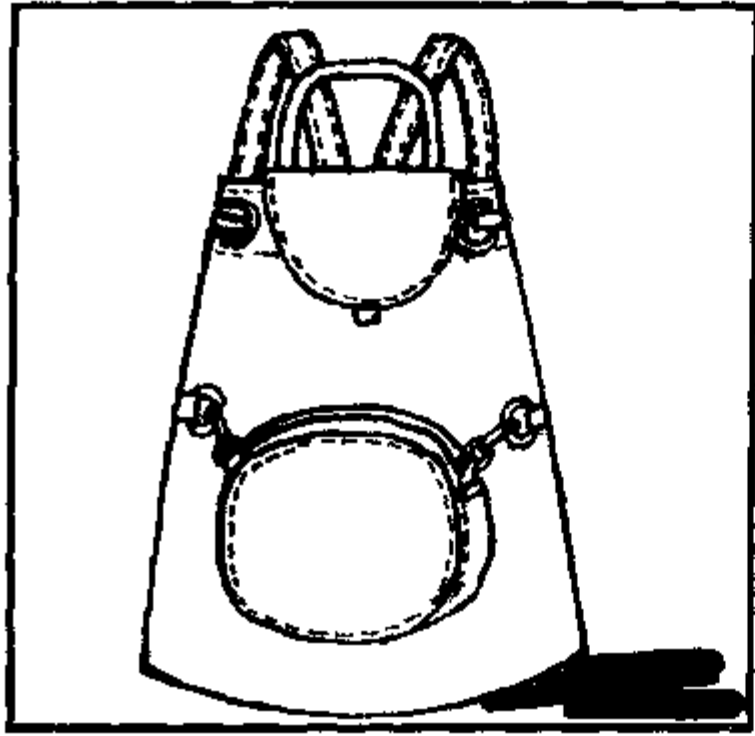

● 双肩背子母袋

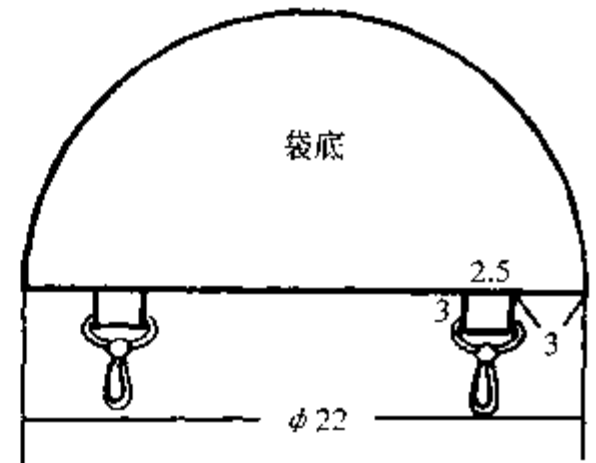
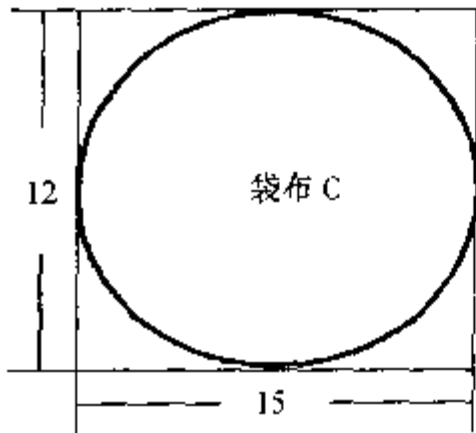
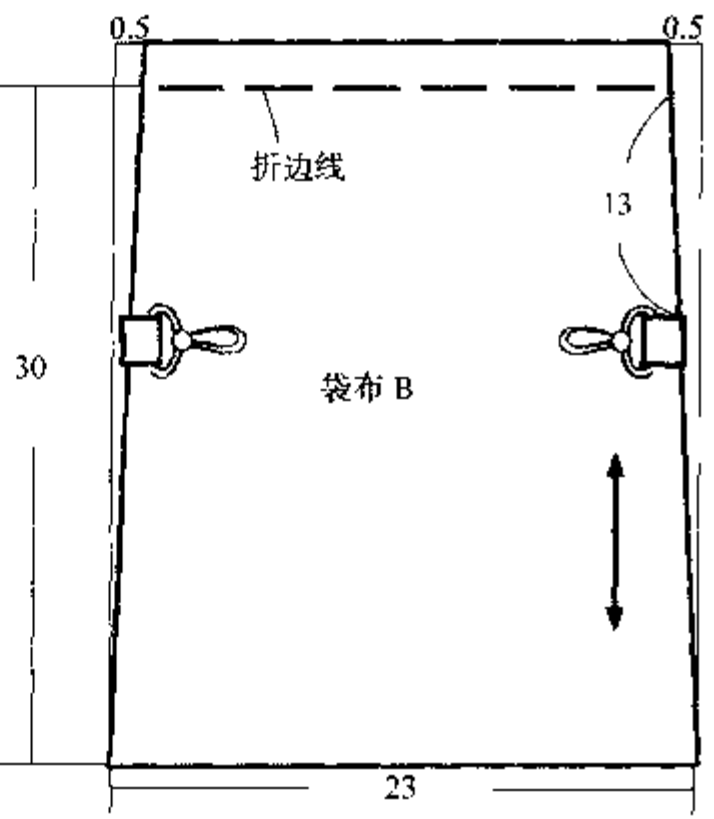
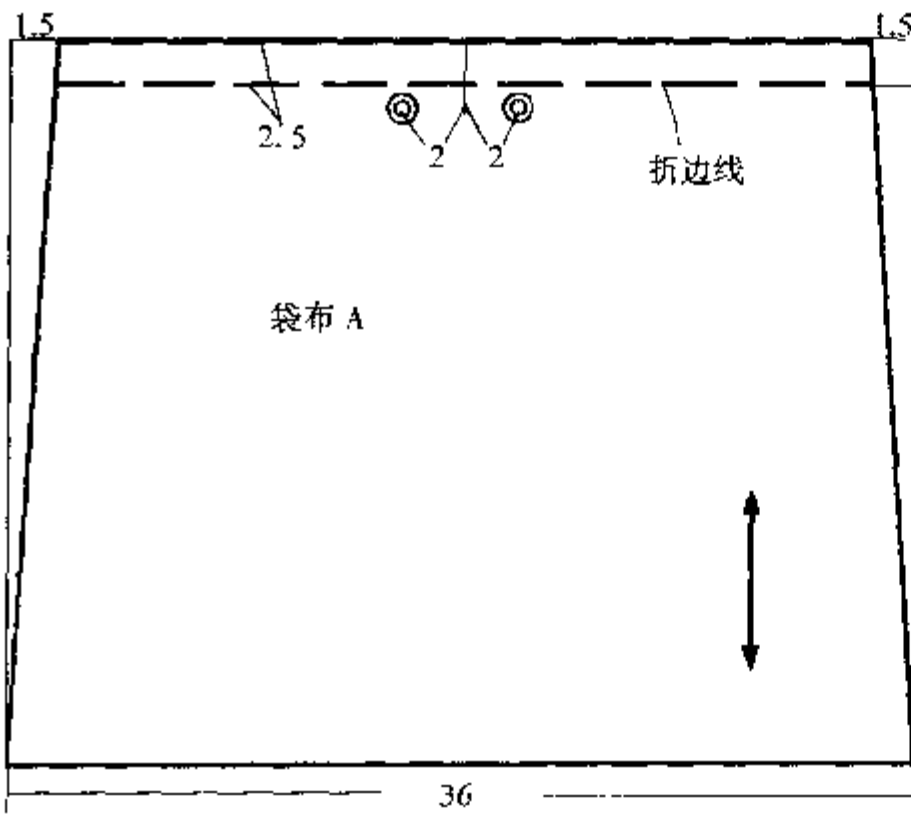
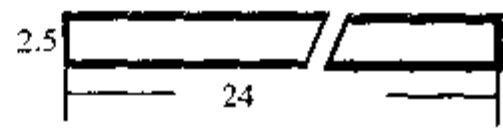

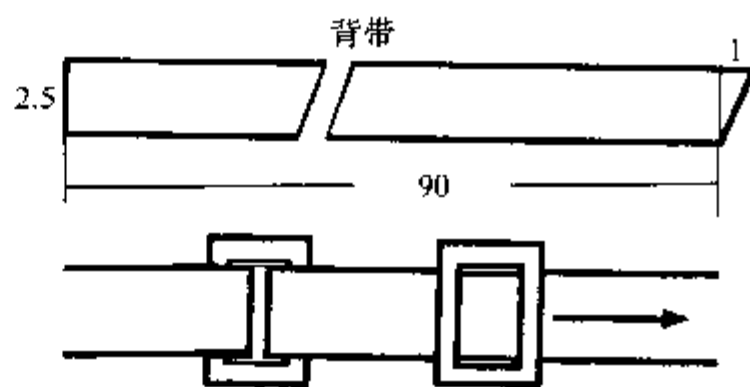
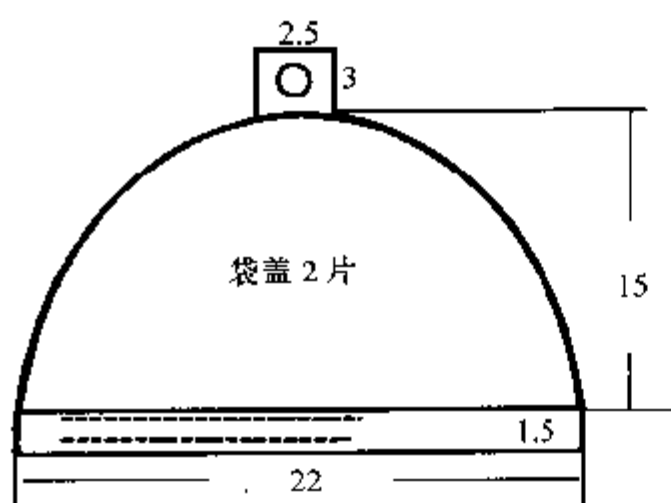

①制作小挂包

a. 缝开口拉链

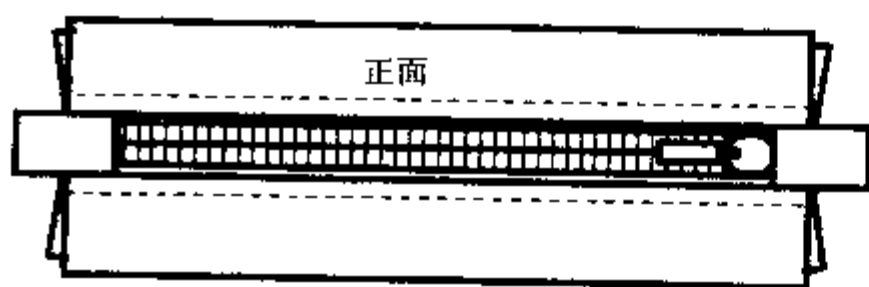

c. 缝合成型的袋墙

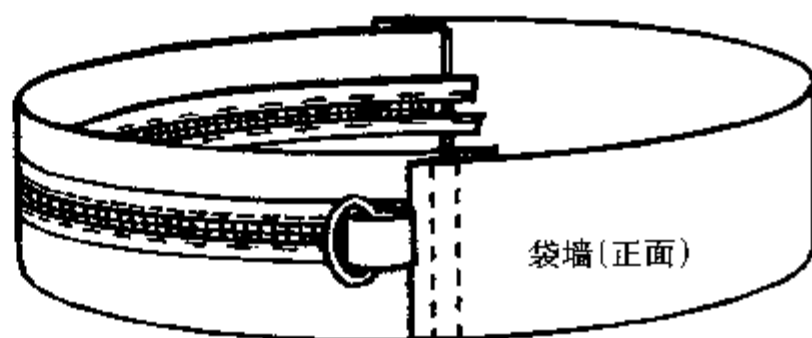

b. 缝合袋墙

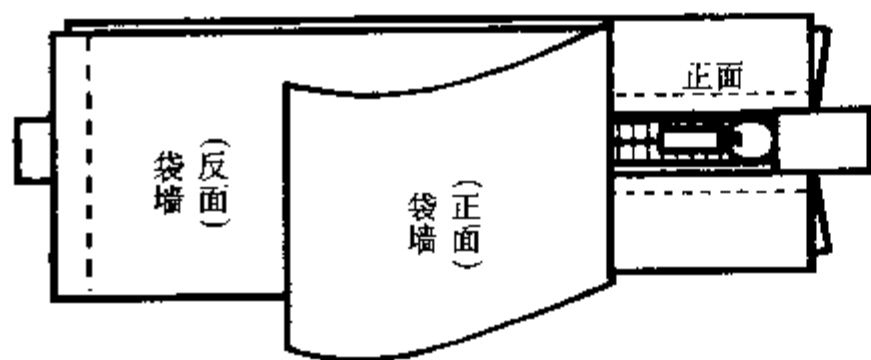

d. 袋墙与前、后袋布缝合

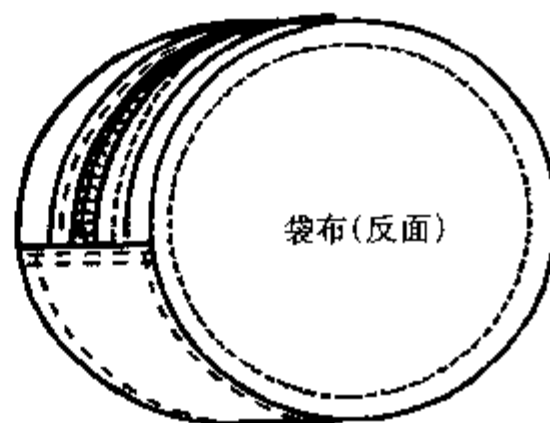

e. 表面缉明线

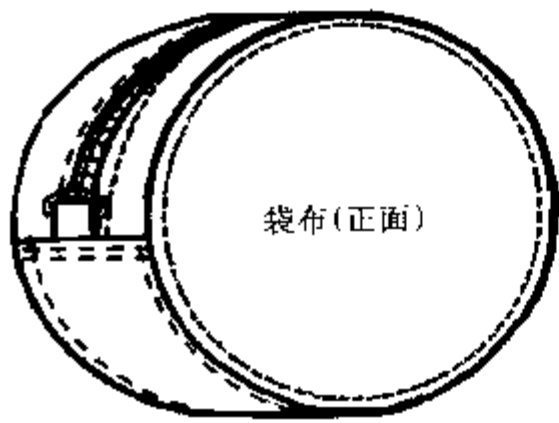

②将挂钩袂与后袋布缝合

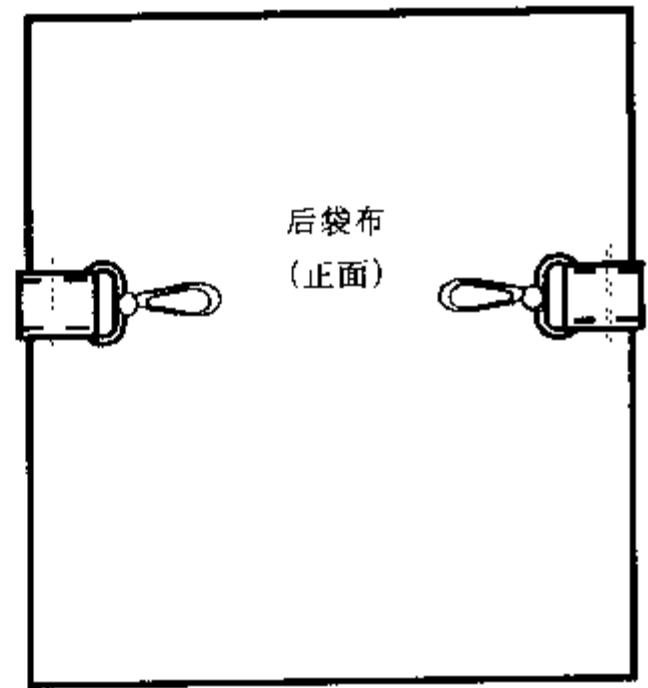

③缝合两边侧缝

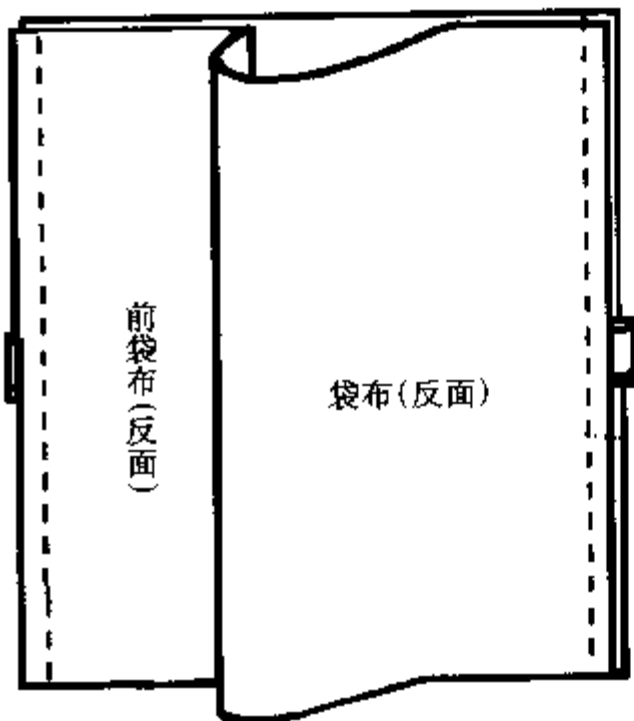

④袋口串绳

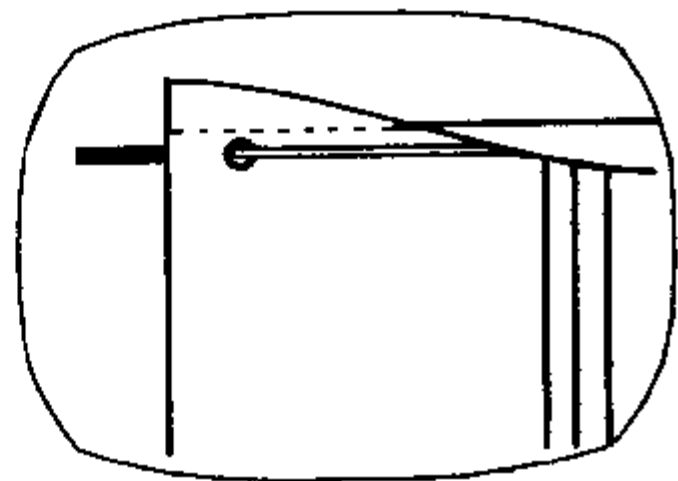

⑤袋底加袂并与袋布缝合

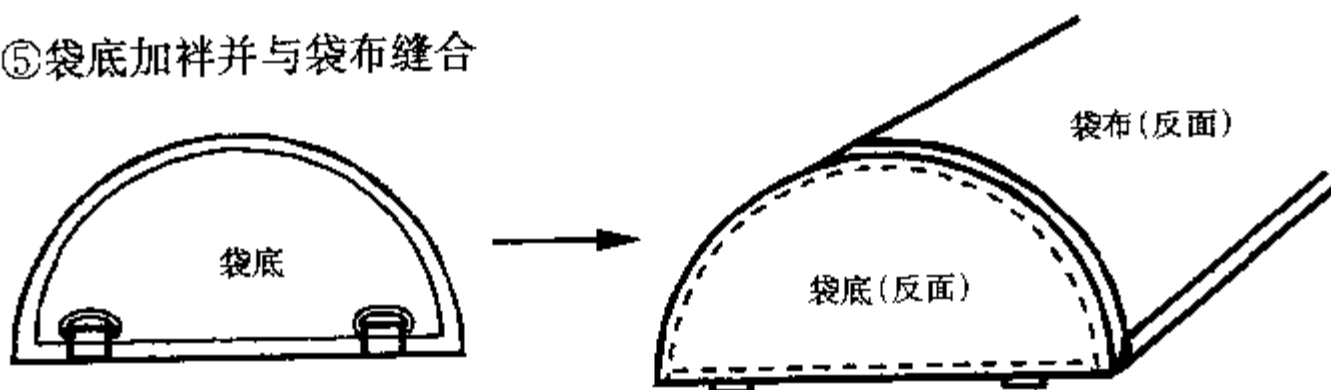

⑥制作背带并加金属扣

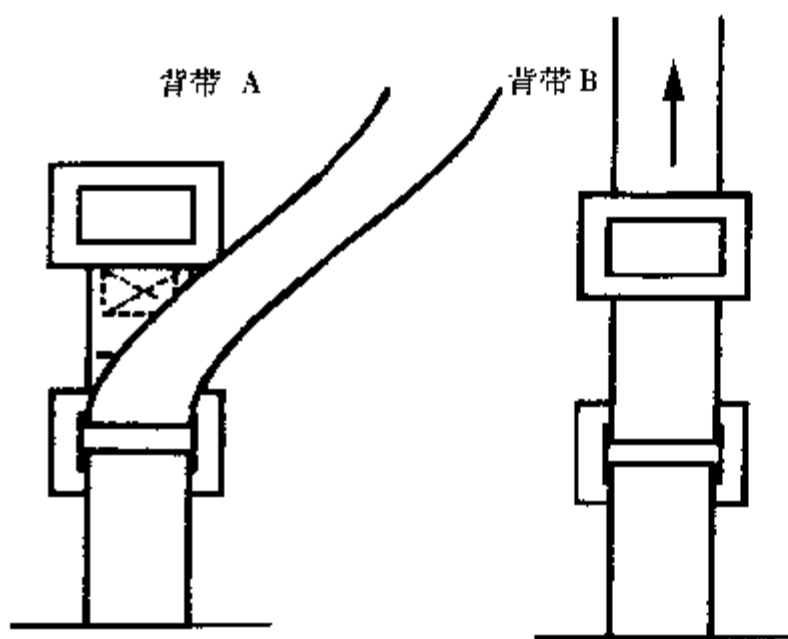

⑦加扣袷做袋盖

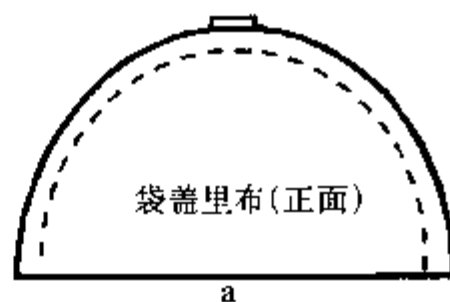

⑧将背带、提带、袋盖缝合于袋布上

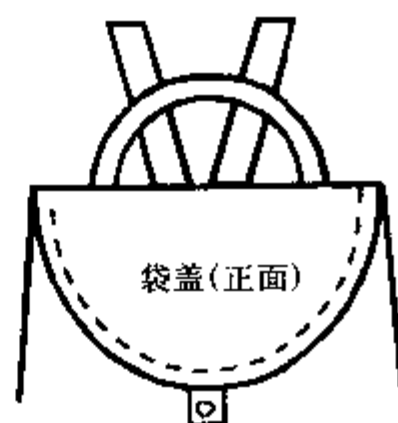
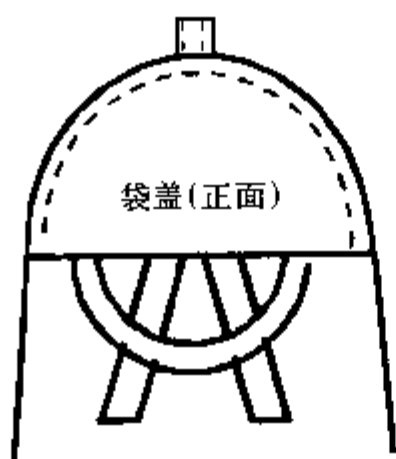
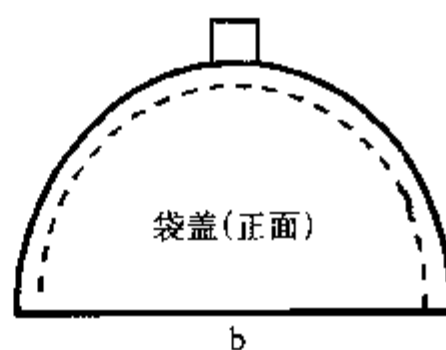
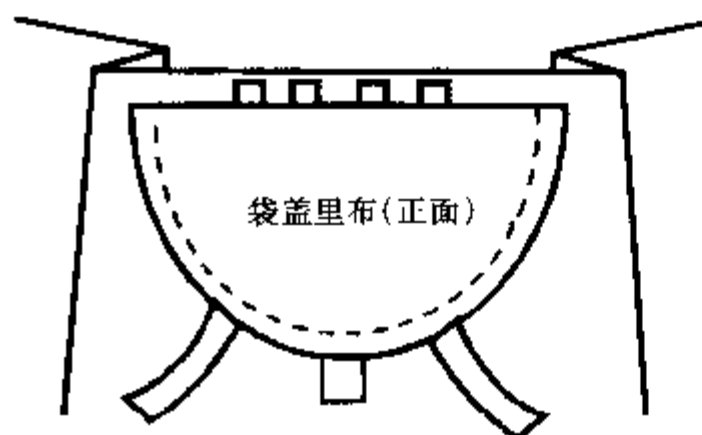



●抽口少女双肩背袋

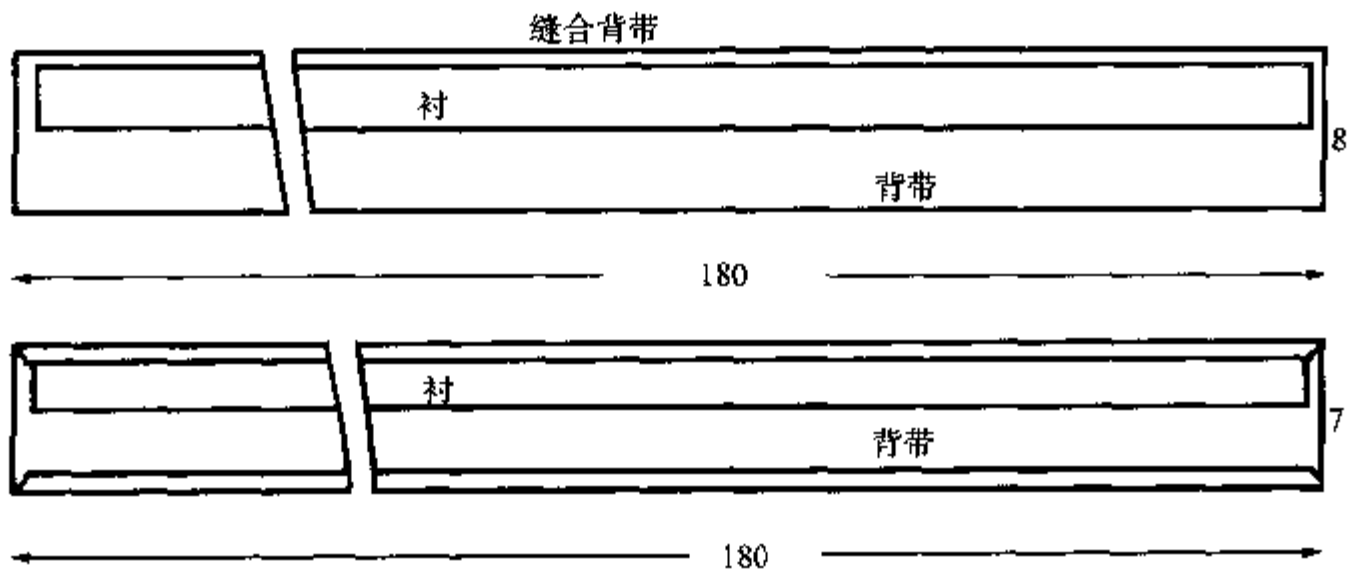
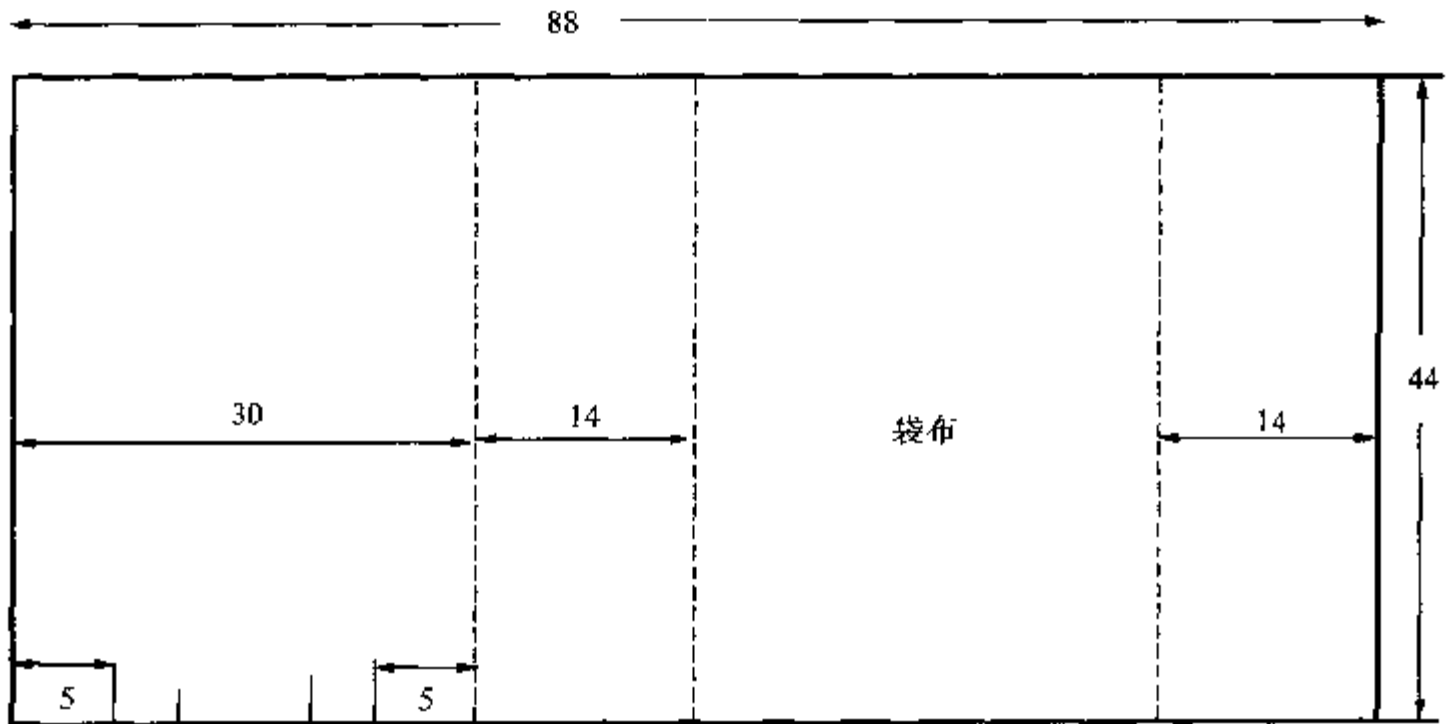
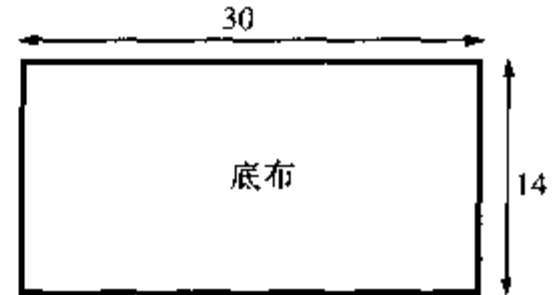

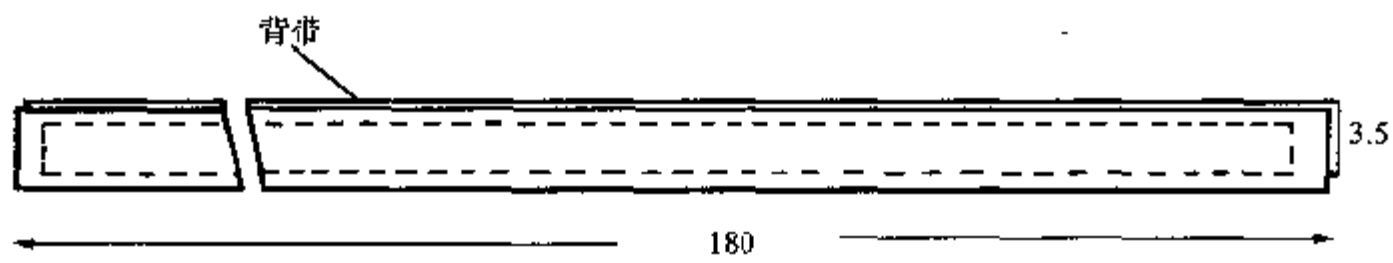

①在袋布的串绳位上钉气眼

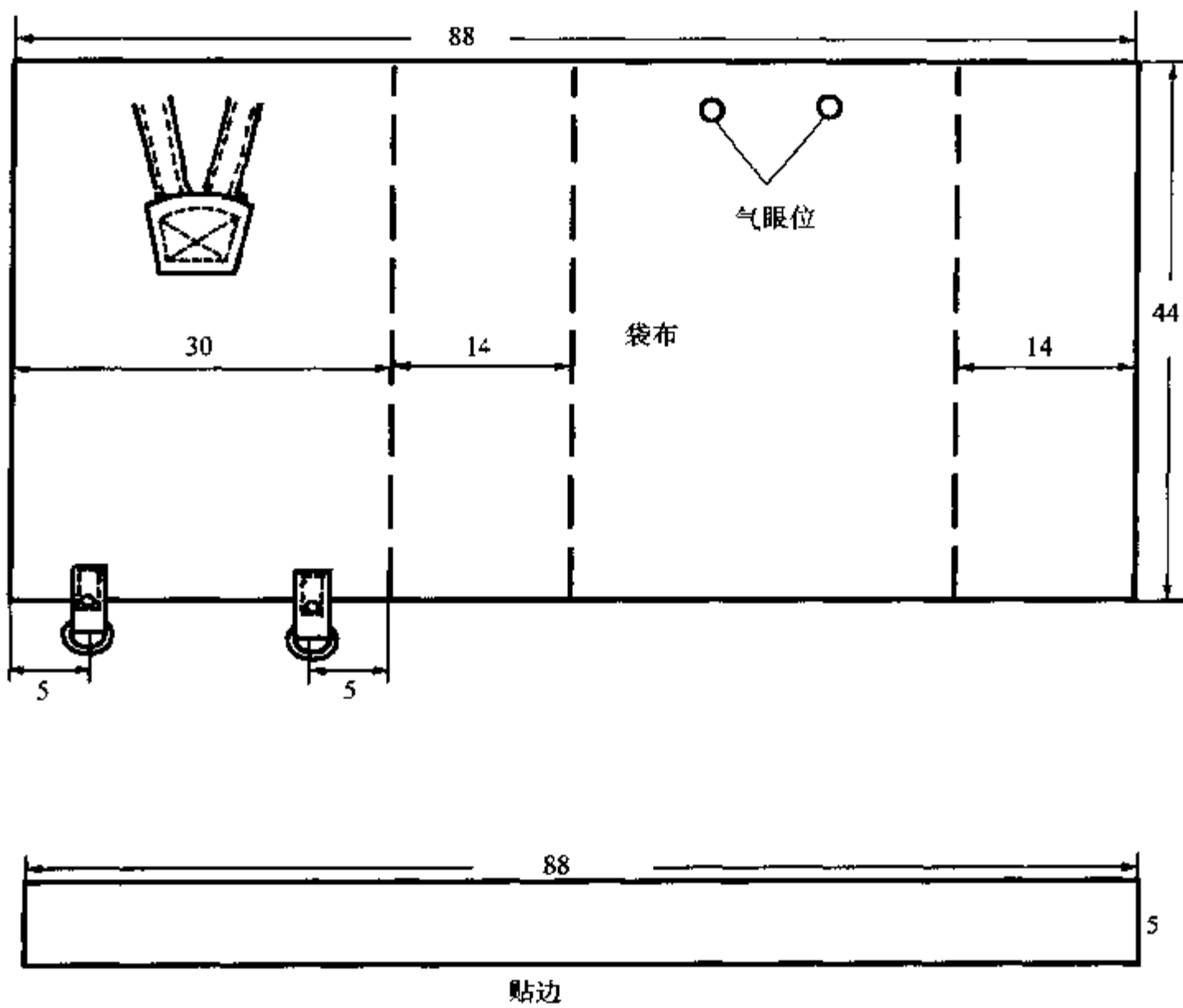

②缝合袋布

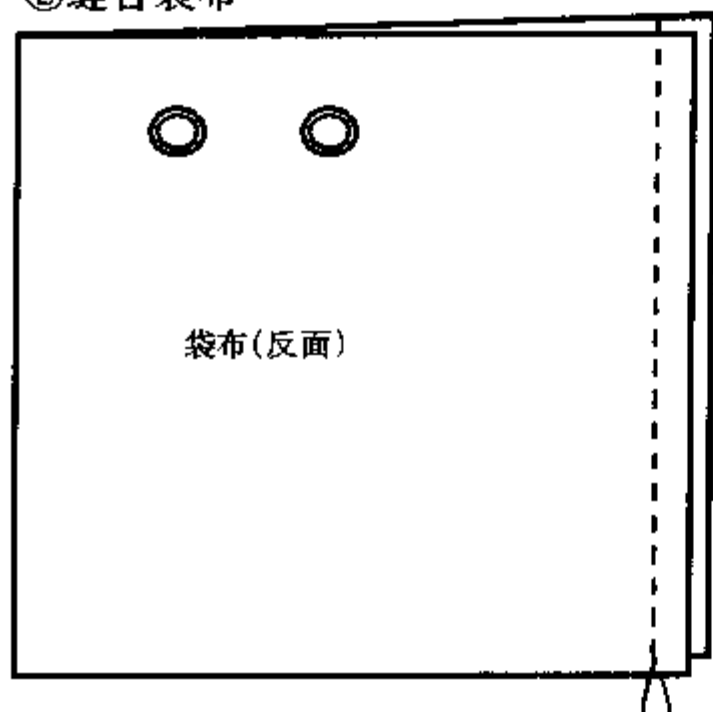

③缝合袋口贴边

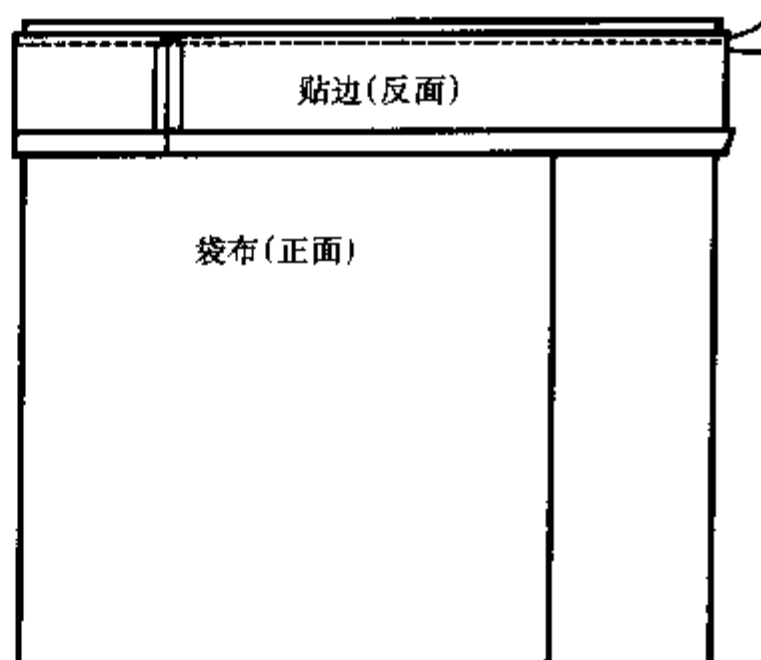

④缉缝贴边下缘

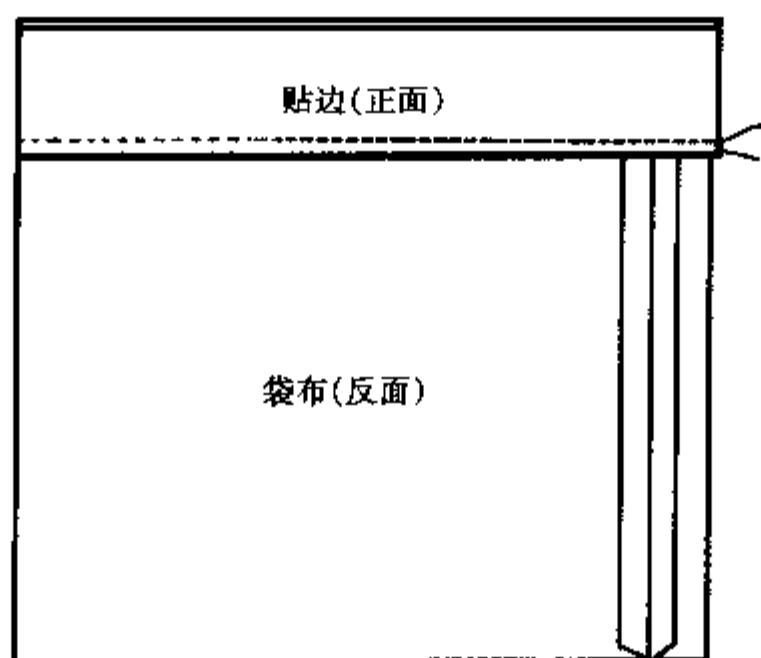

⑥串抽绳

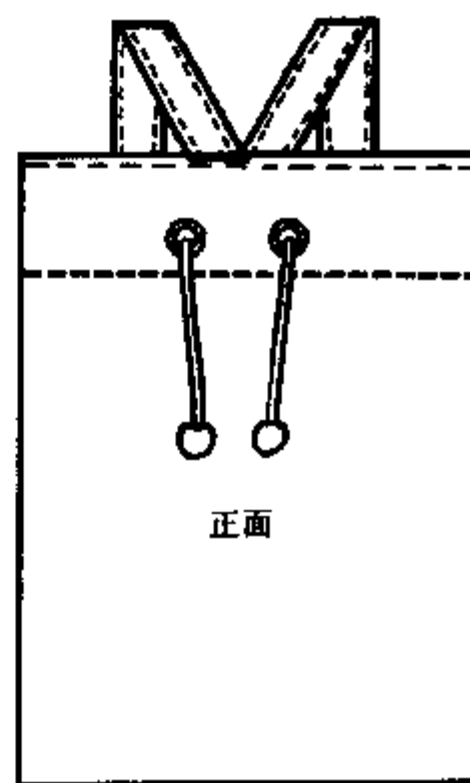

⑤缝合袋底

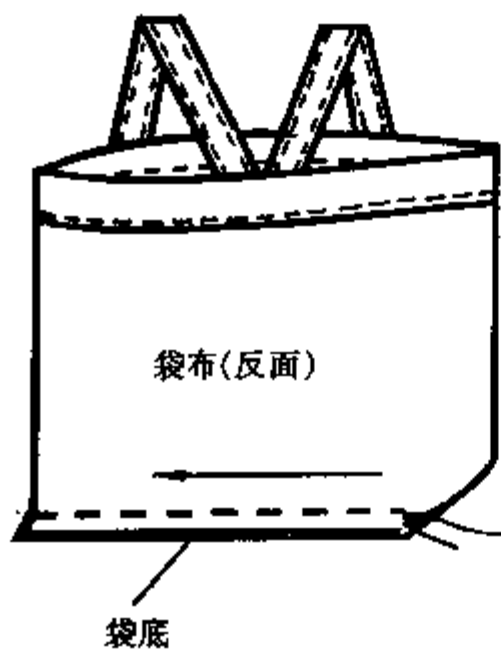

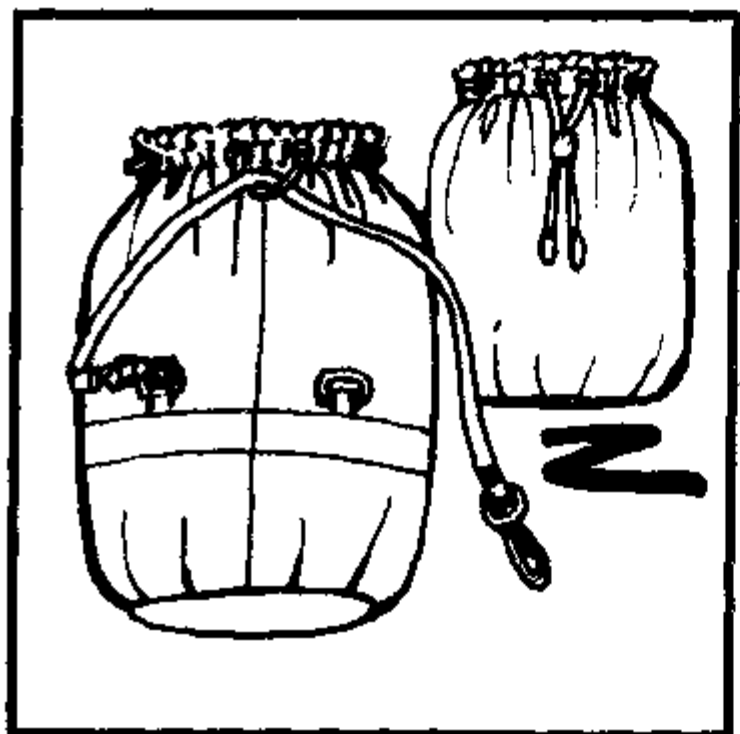

● 旅游抽口双肩背圆筒袋

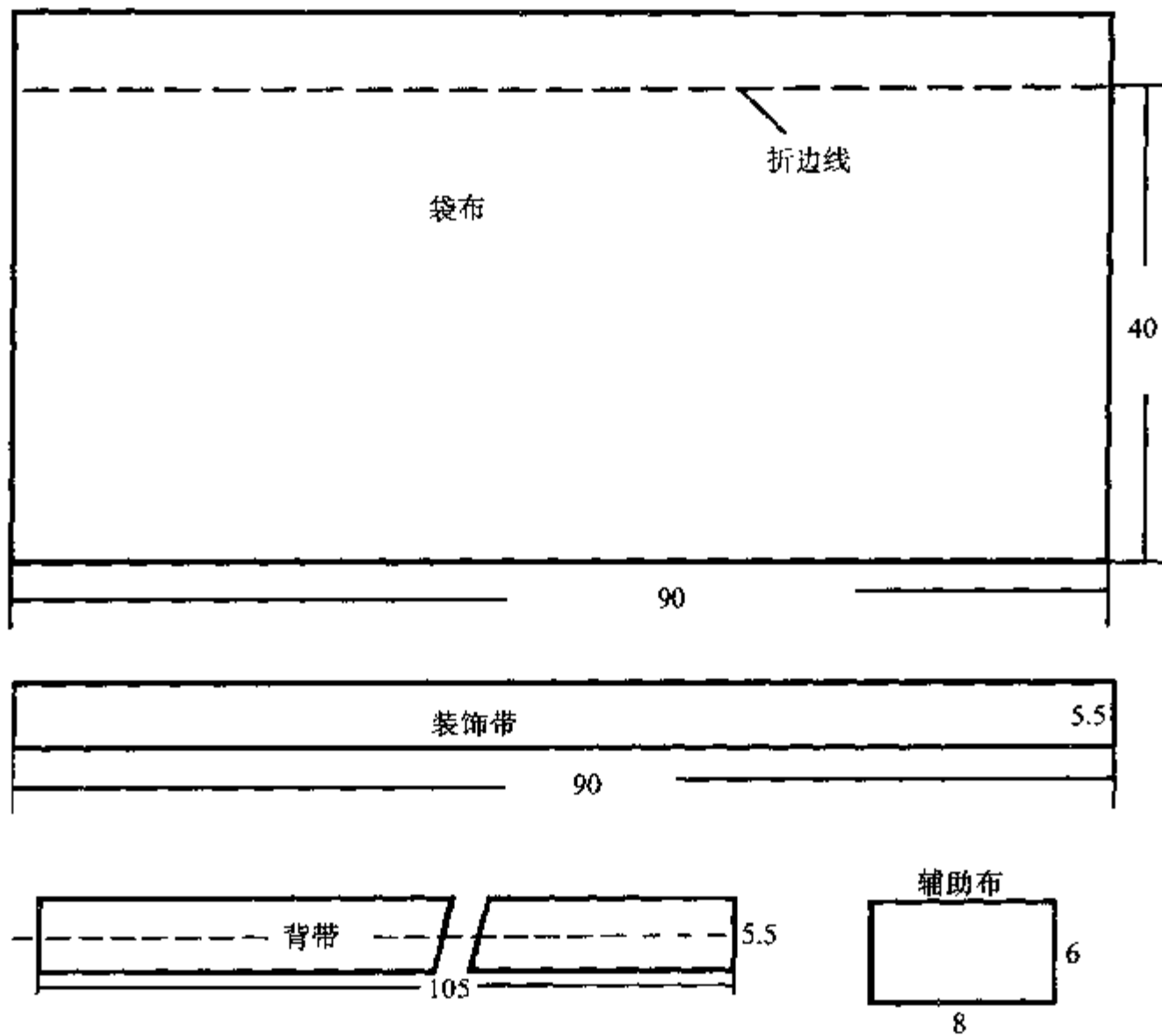
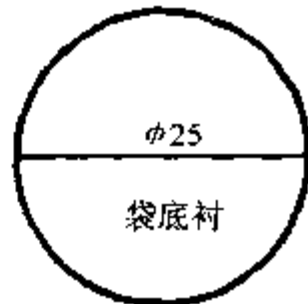
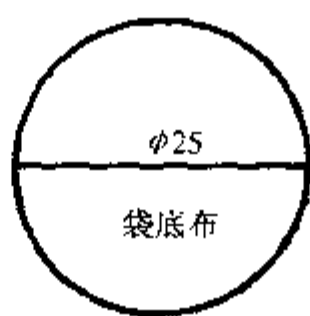

①折装饰带边

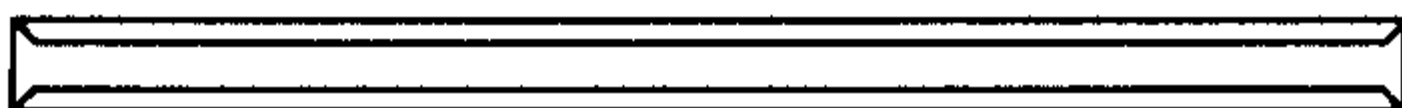

装饰带(反面)

②缉缝装饰带边并夹缝吊环

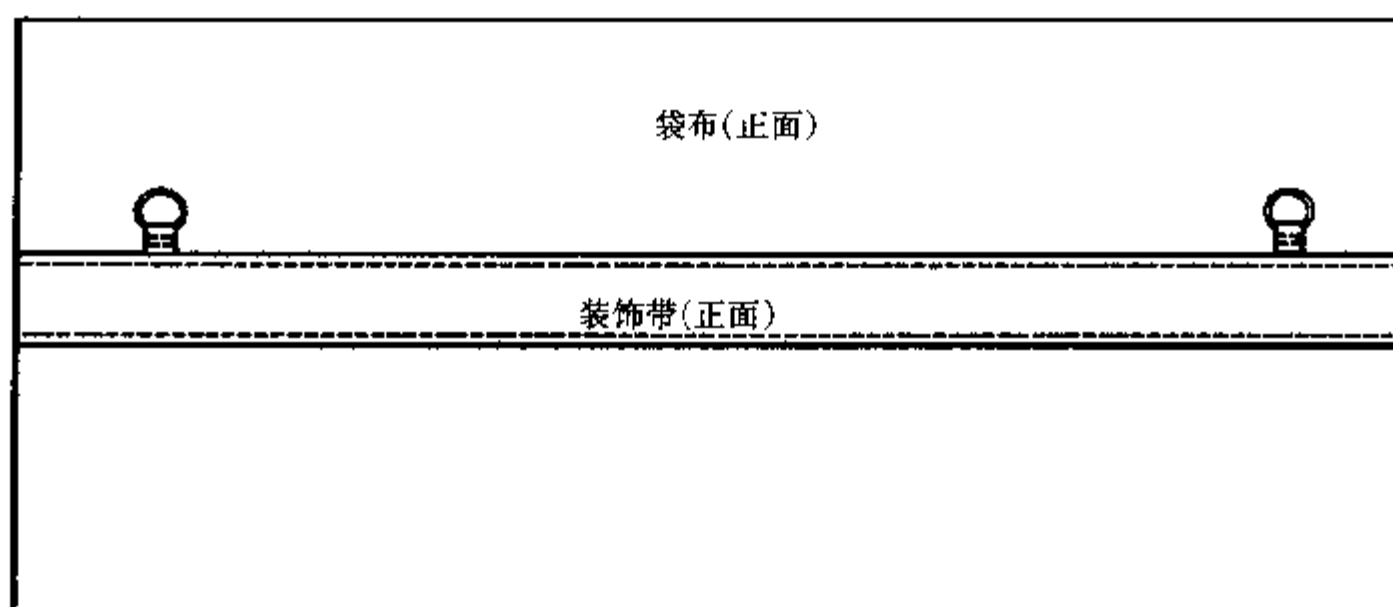

袋布(正面)

装饰带(正面)

③将包袋的后中心线缝合,并劈缝熨烫

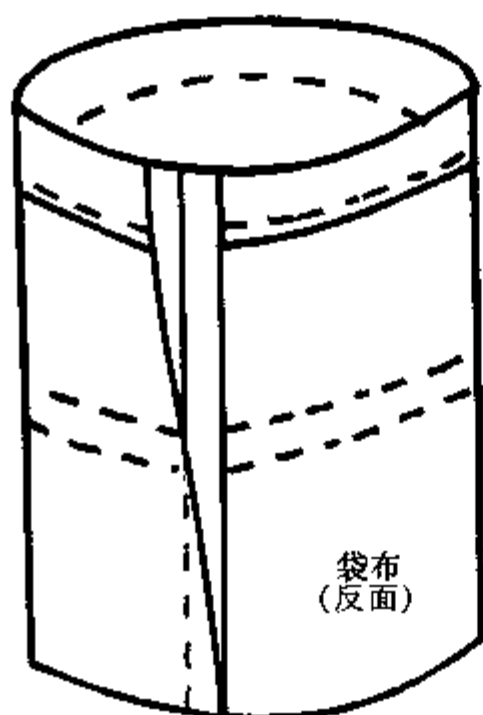

袋布(反面)

④袋口处钉气眼

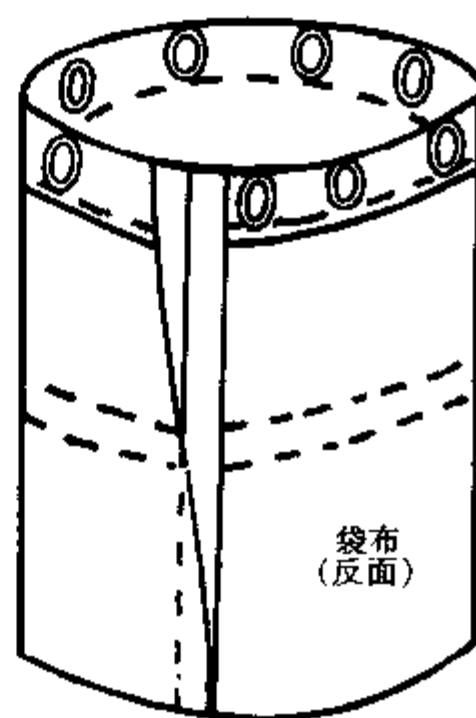

袋布(反面)

⑤缝合袋底布

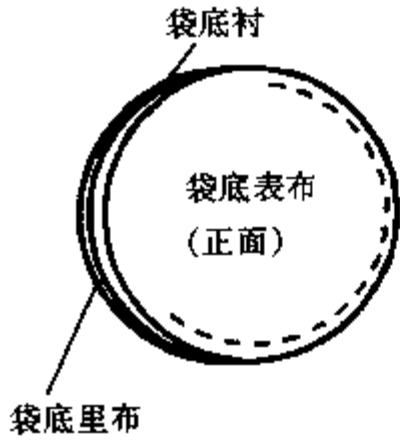

⑥将袋底布与袋布缝合

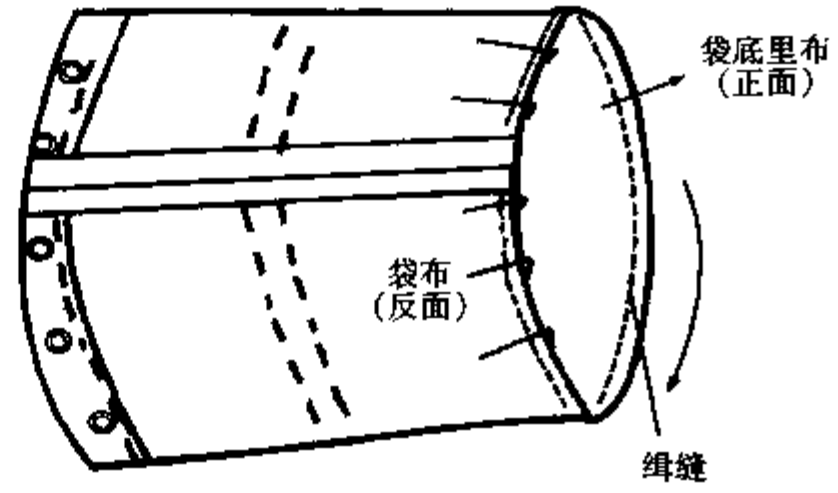

⑦制作辅助部件



⑧串袋口绳

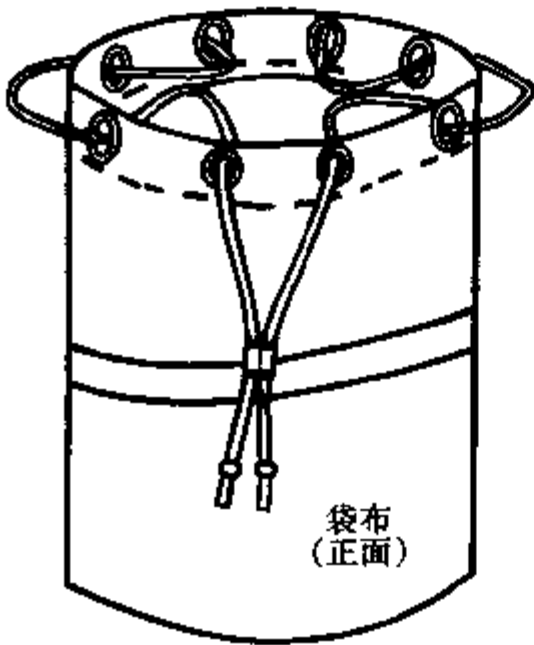

⑨缝背带

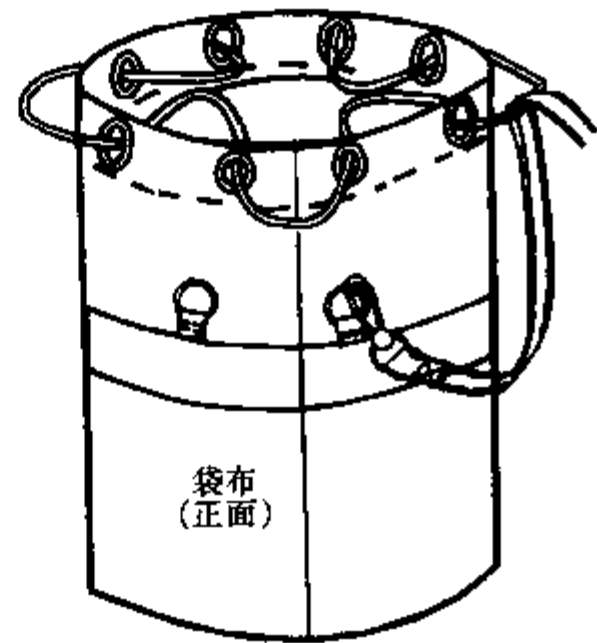



● 蝶结装饰购物提包

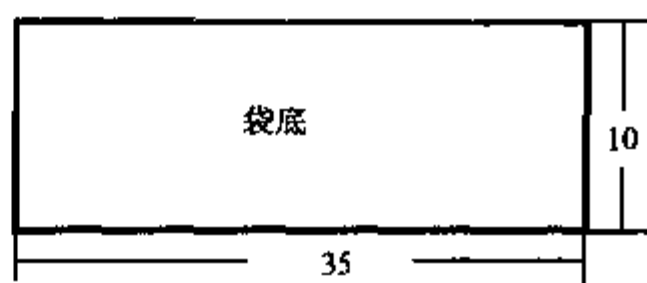
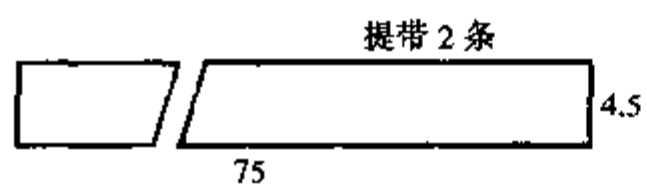
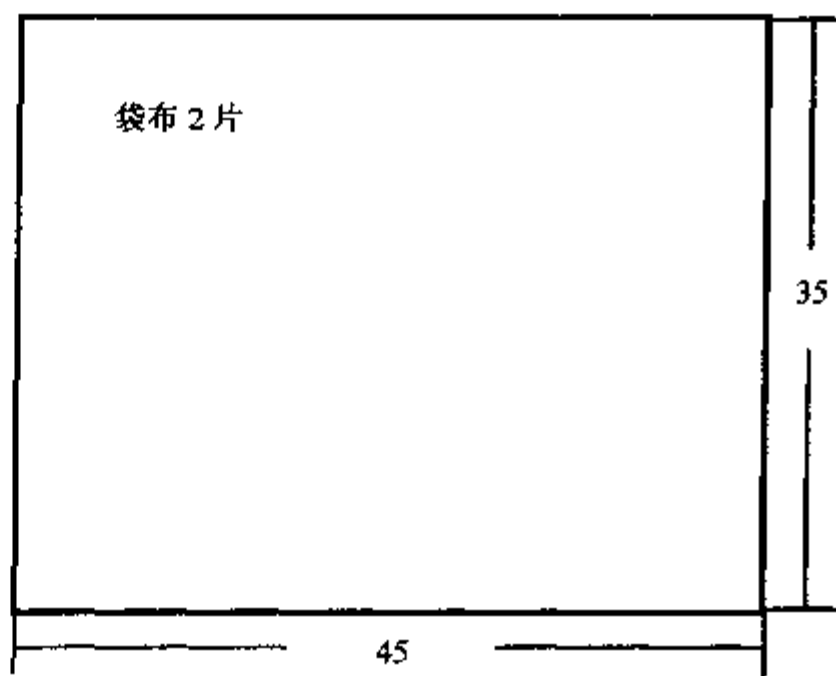

① 缝合袋布两边侧缝

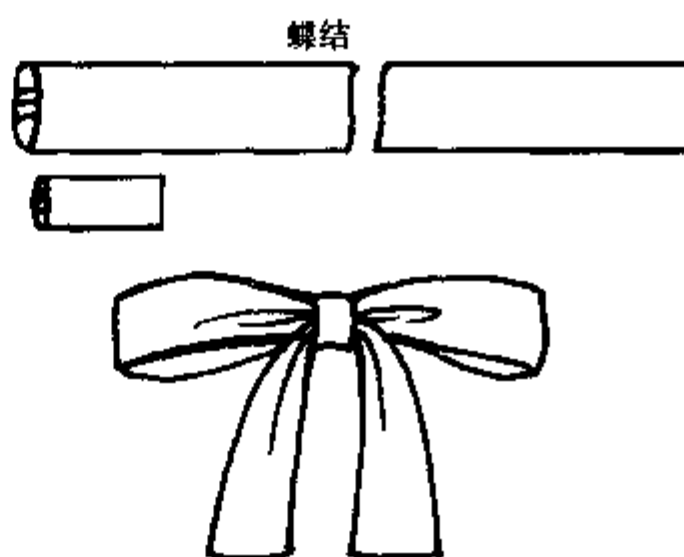
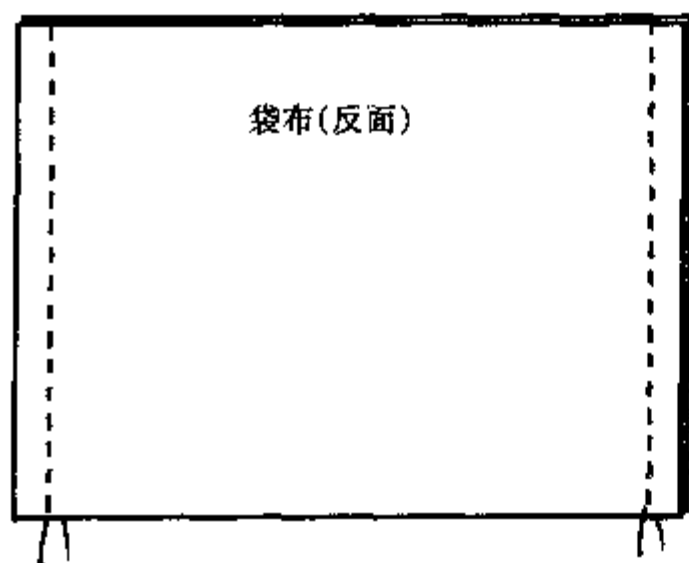

②袋底加衬并与袋布缝合

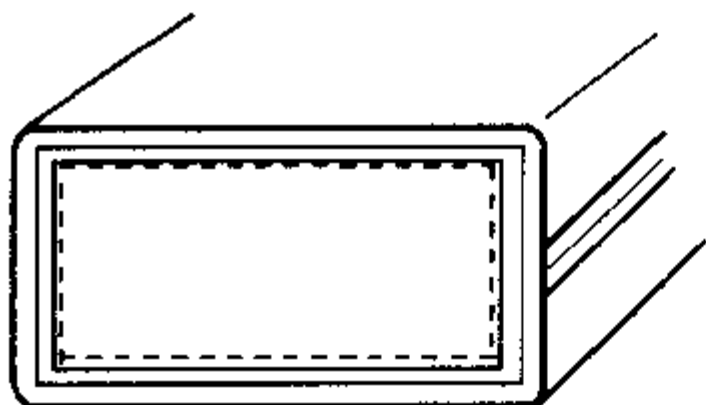

③袋口内加贴边,缉明线

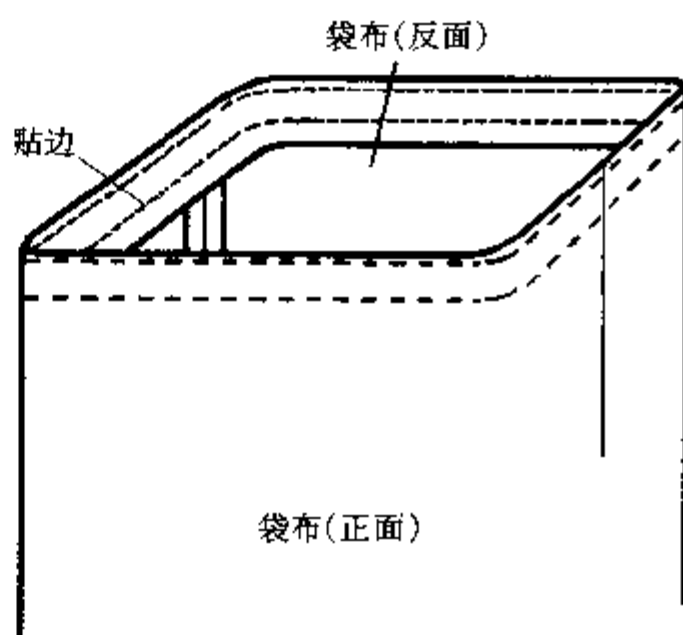

④缝提带及装饰带

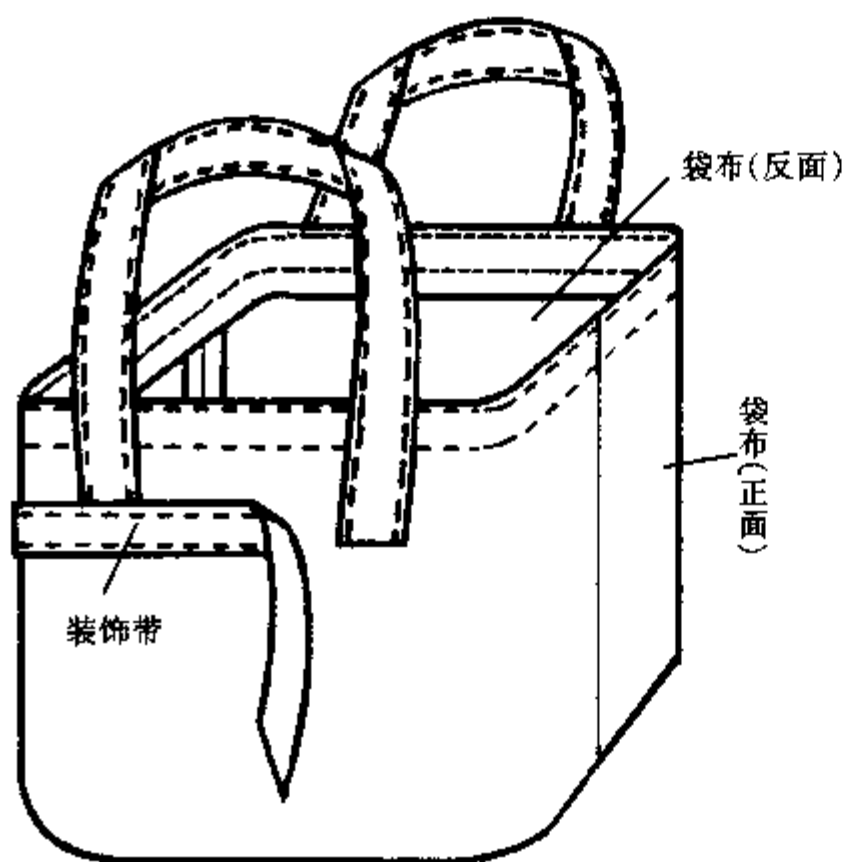

⑤钉组合扣

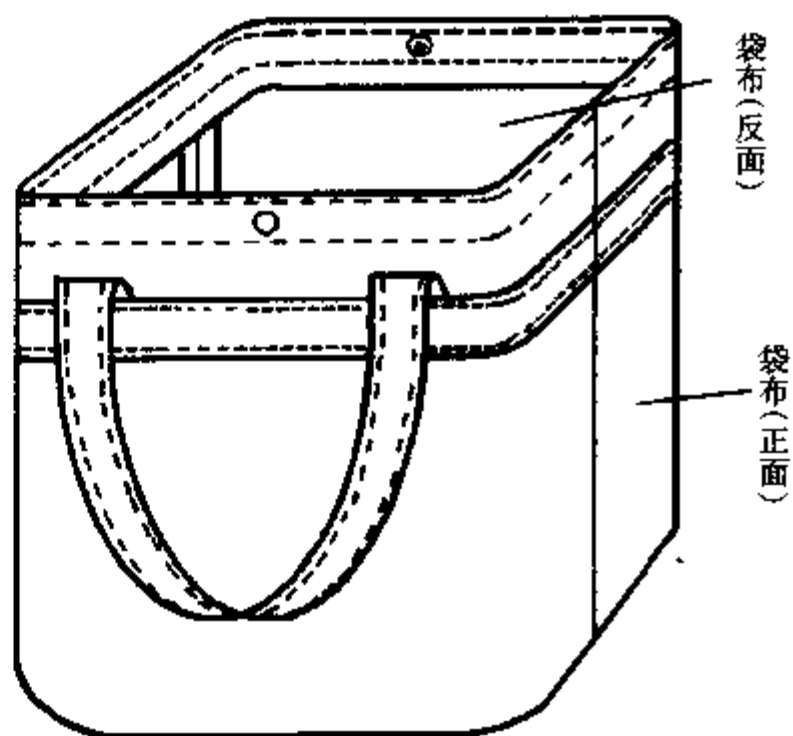

● 休闲购物挎包

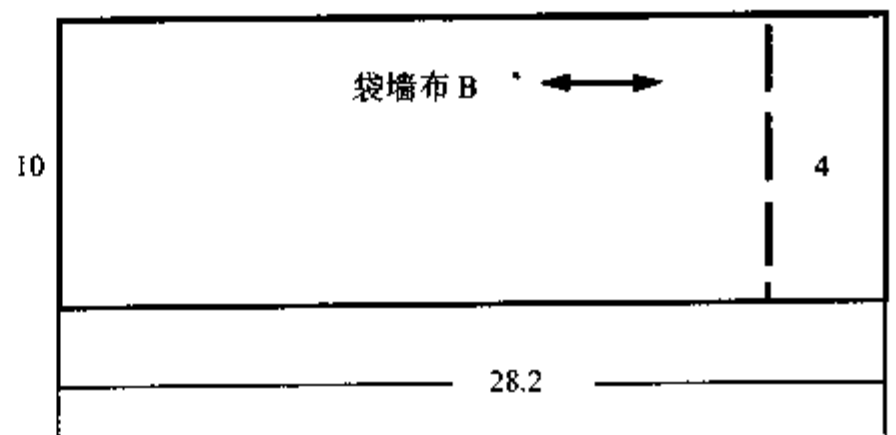
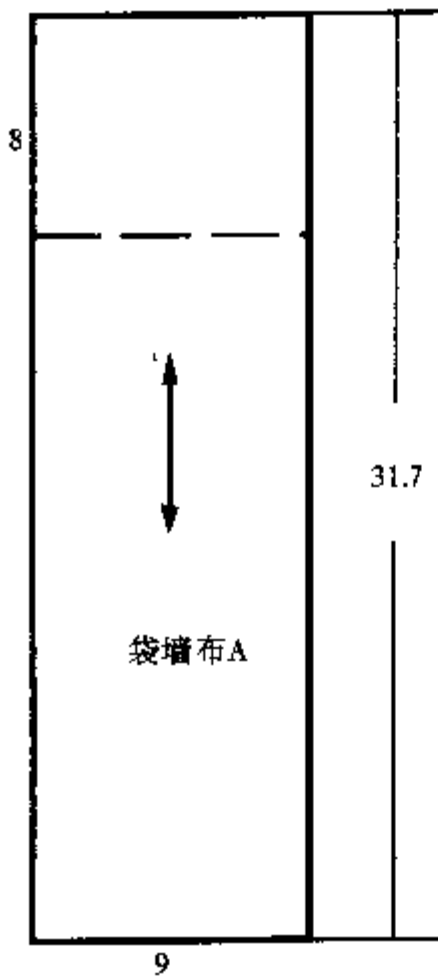
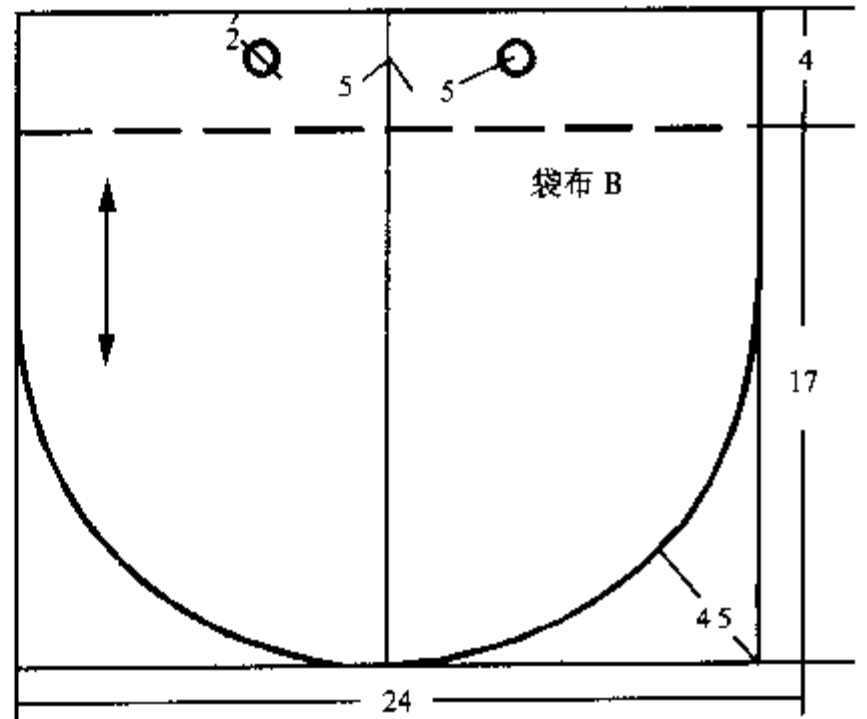
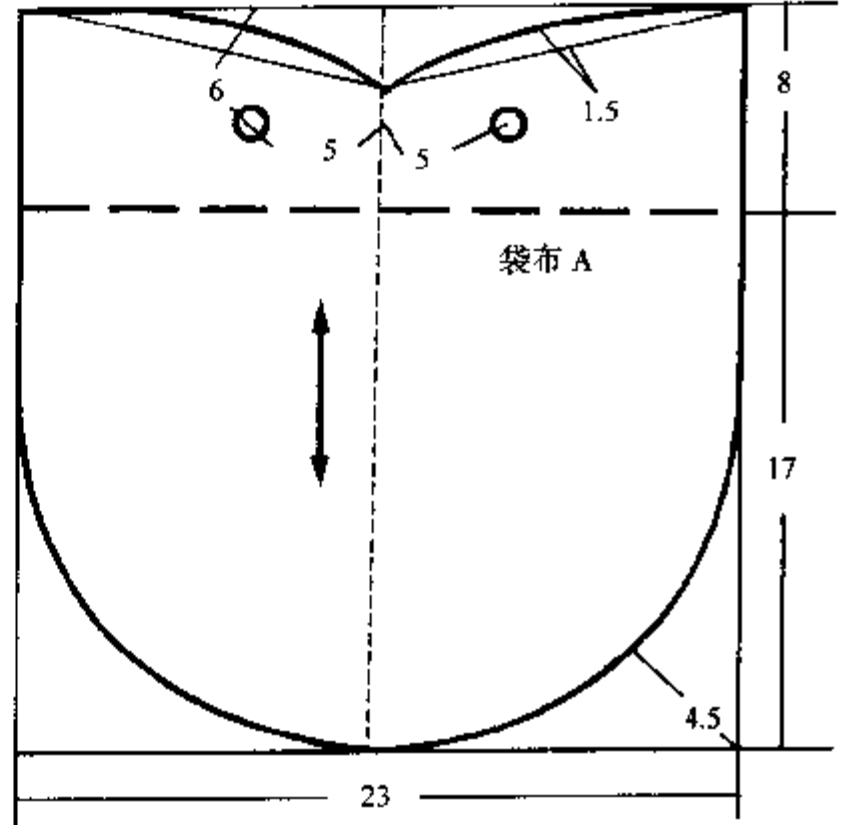

①袋布 A 与袋墙布 A 缝合

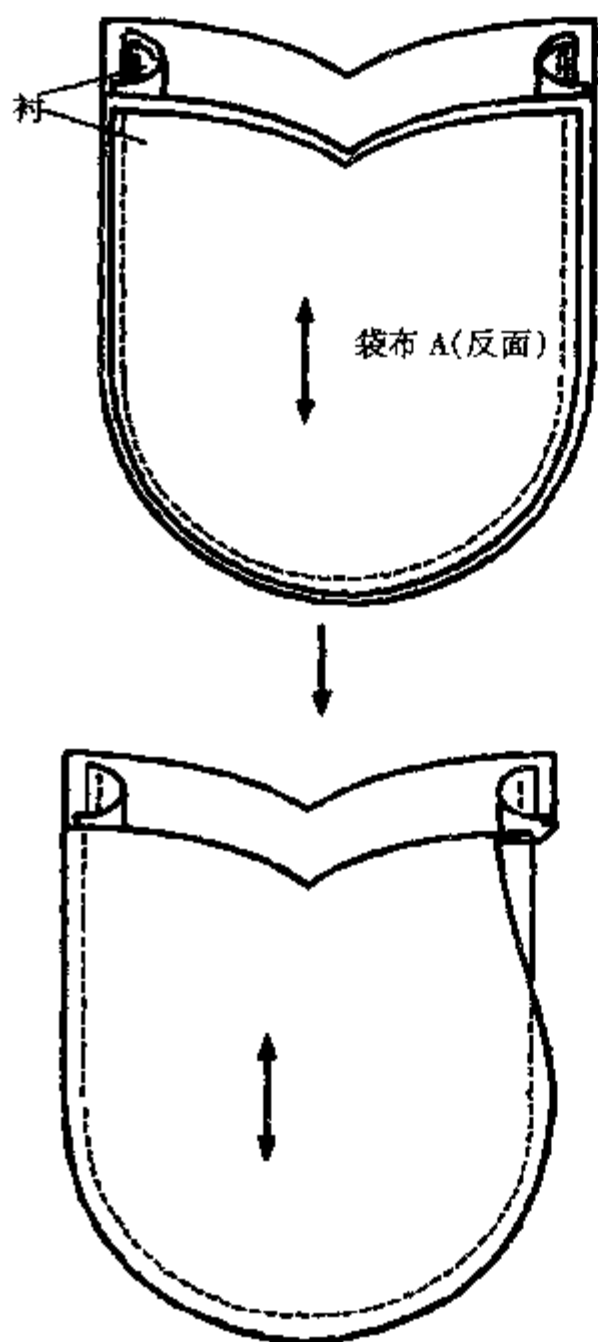

②做袋口贴边



③袋口贴边与袋布 A 缝合

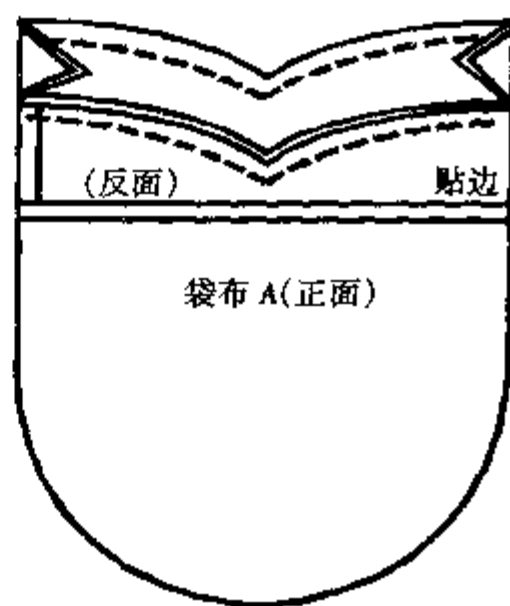

④钉气眼穿绳

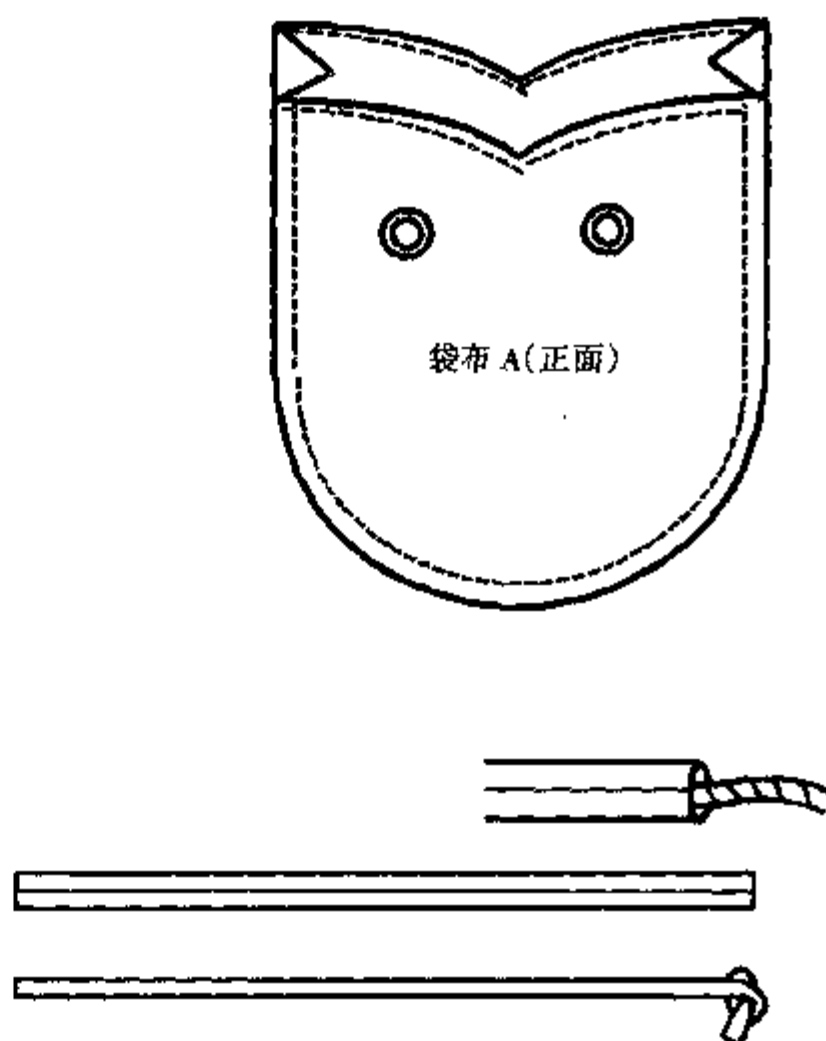

⑤袋布 B 与袋墙布 B 缝合

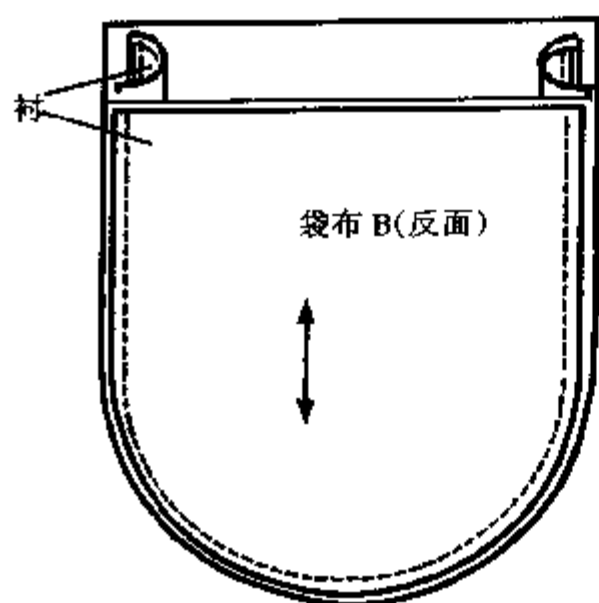

⑥做袋口贴边

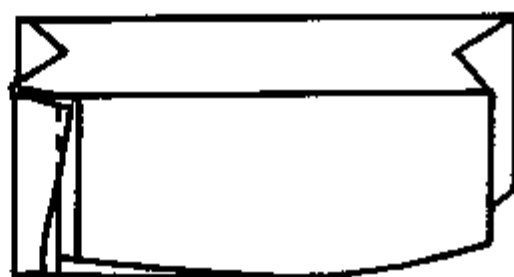

⑦袋口贴边与袋布 B 缝合

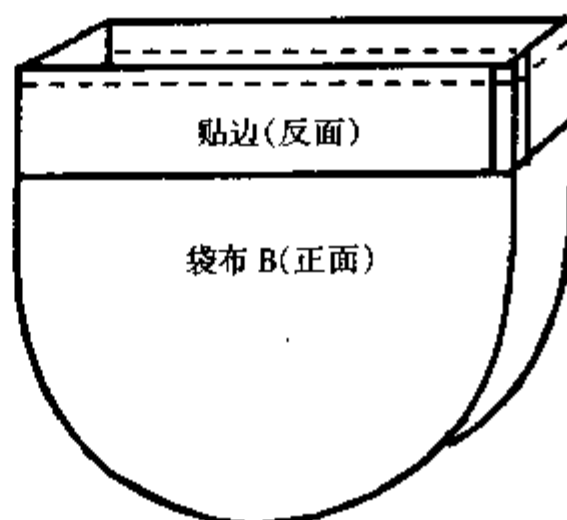
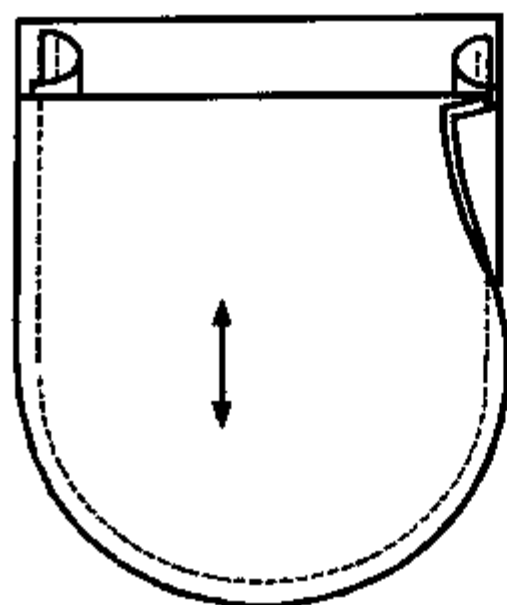

⑧钉气眼穿绳

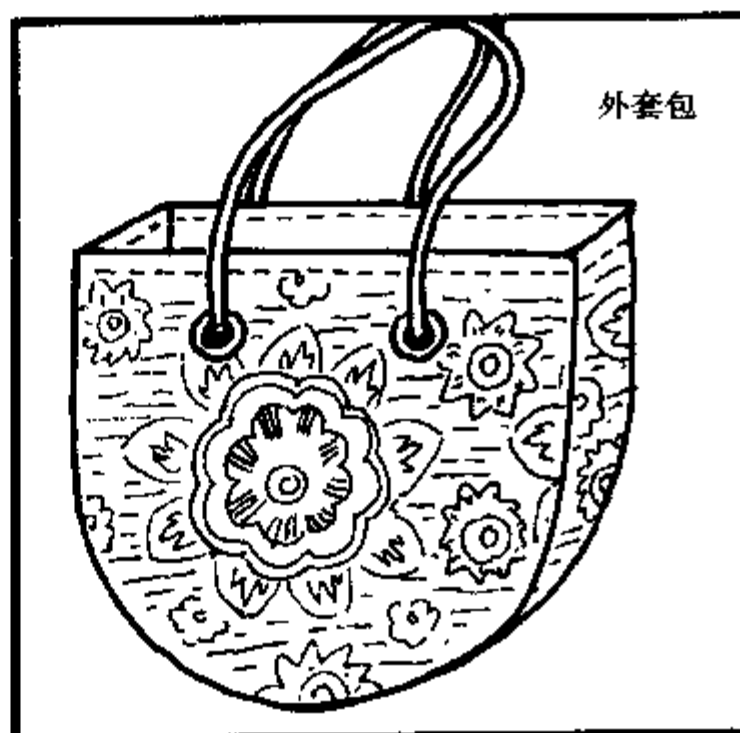
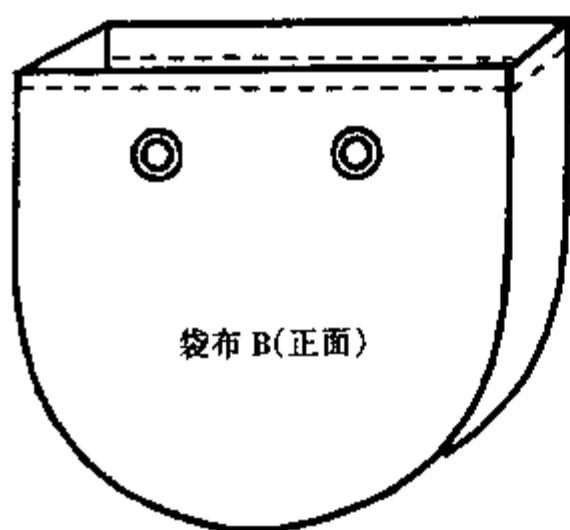

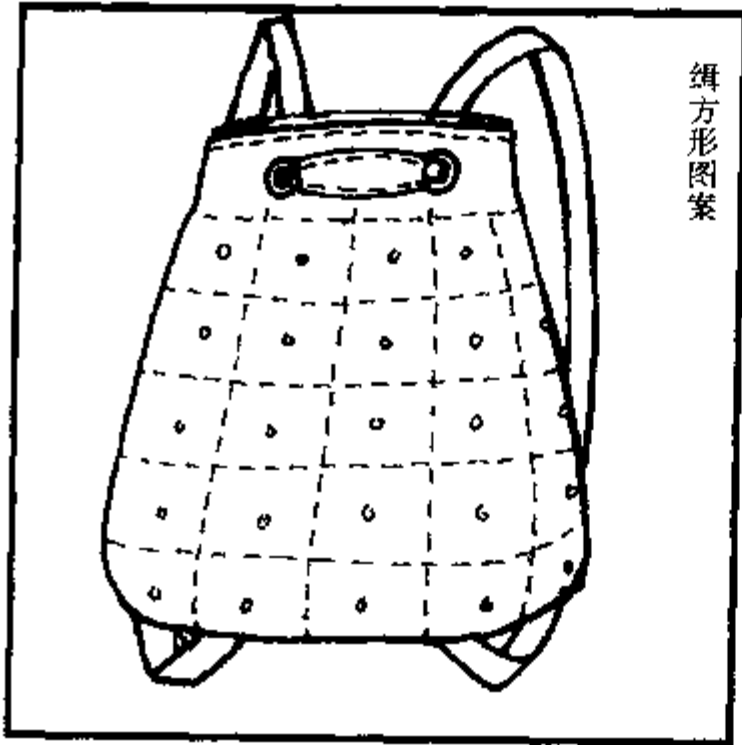

●折口双肩背袋

①袋底布与袋布缝合

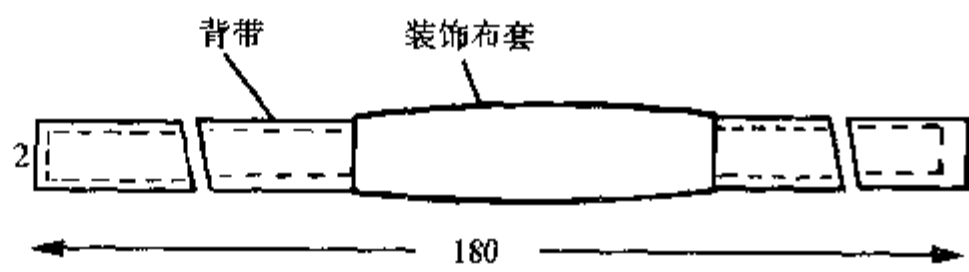
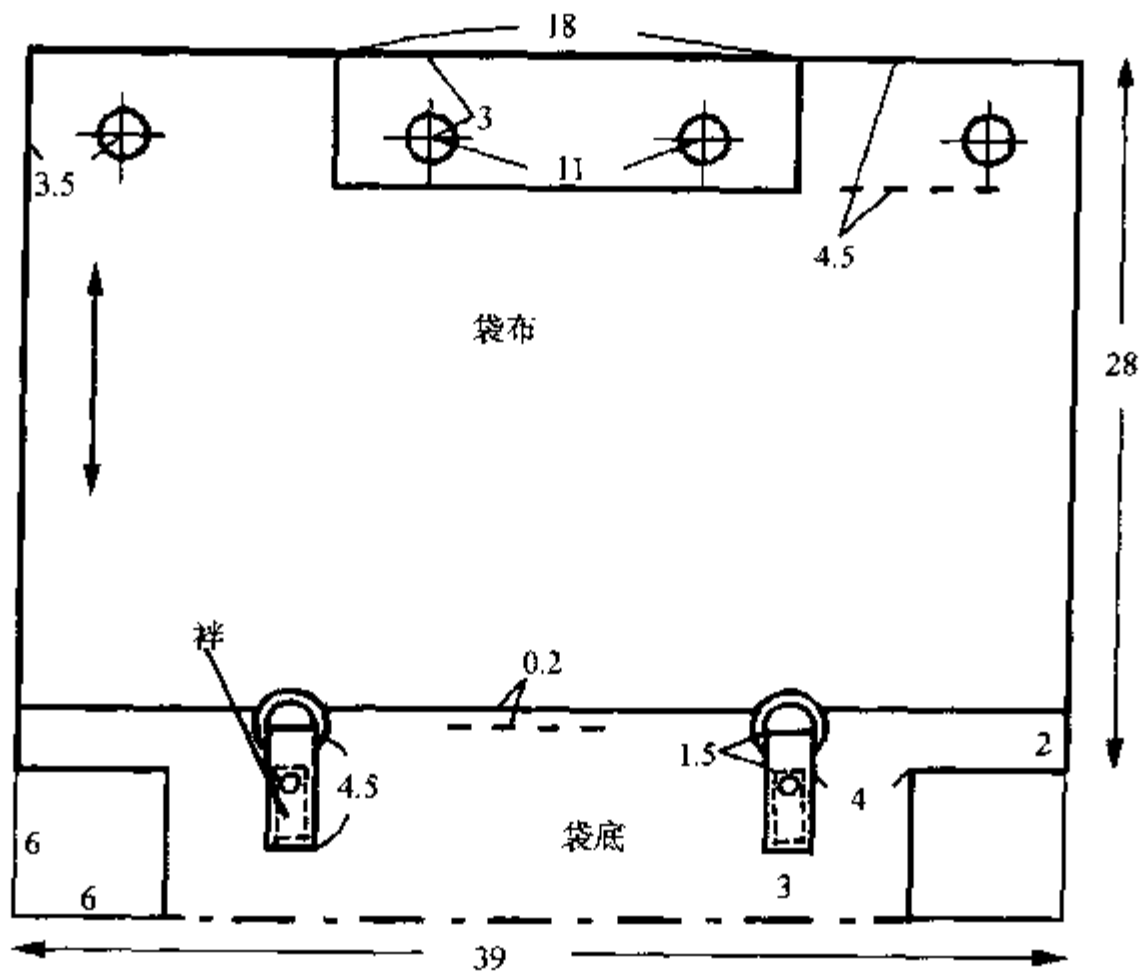
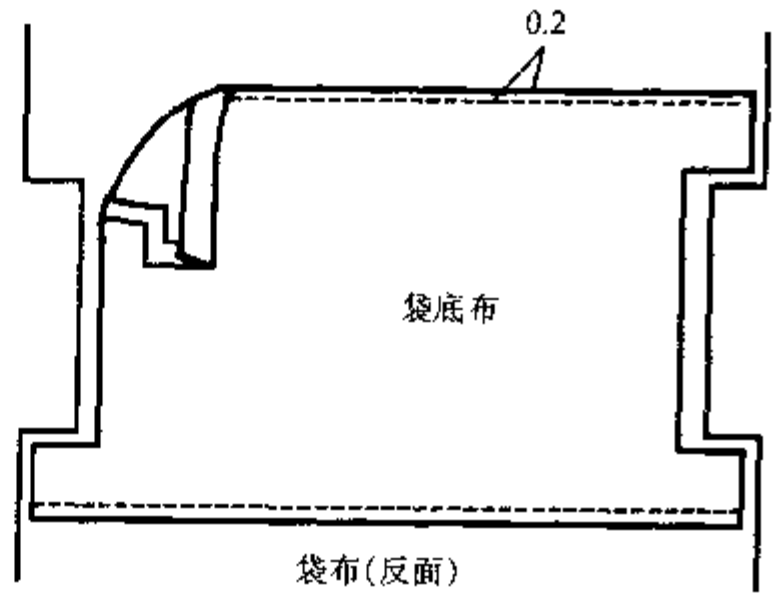

②缝合侧缝和袋底角

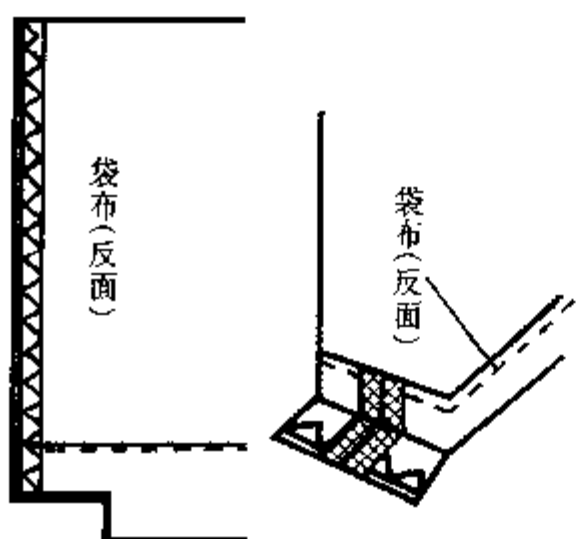

③袋底部加金属环

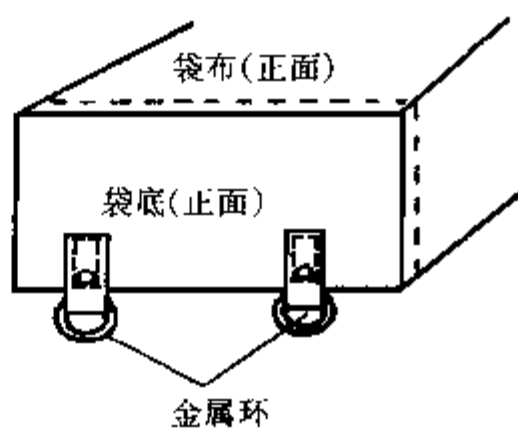

④缝制袋口边

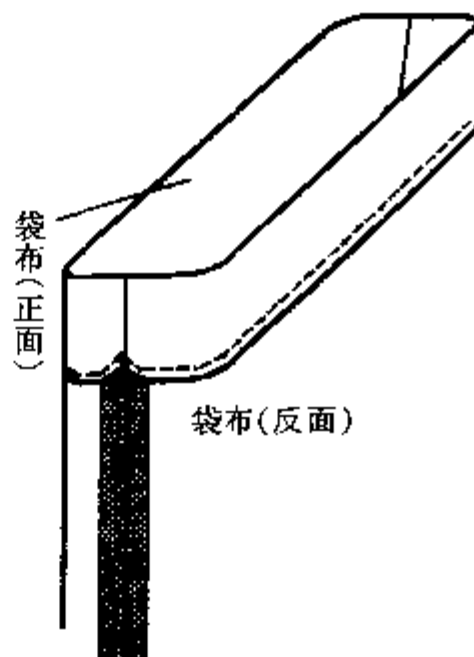
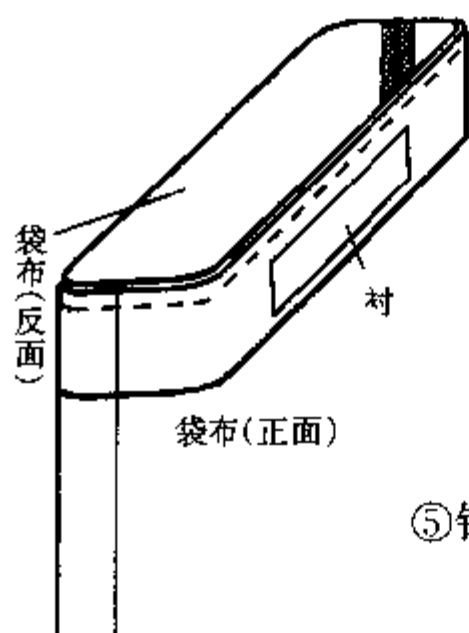

⑤钉气眼

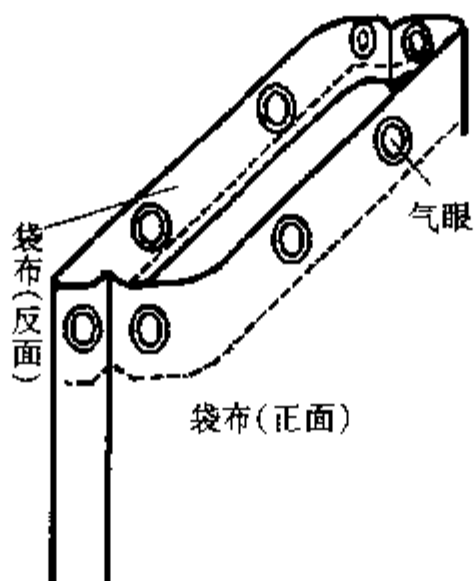

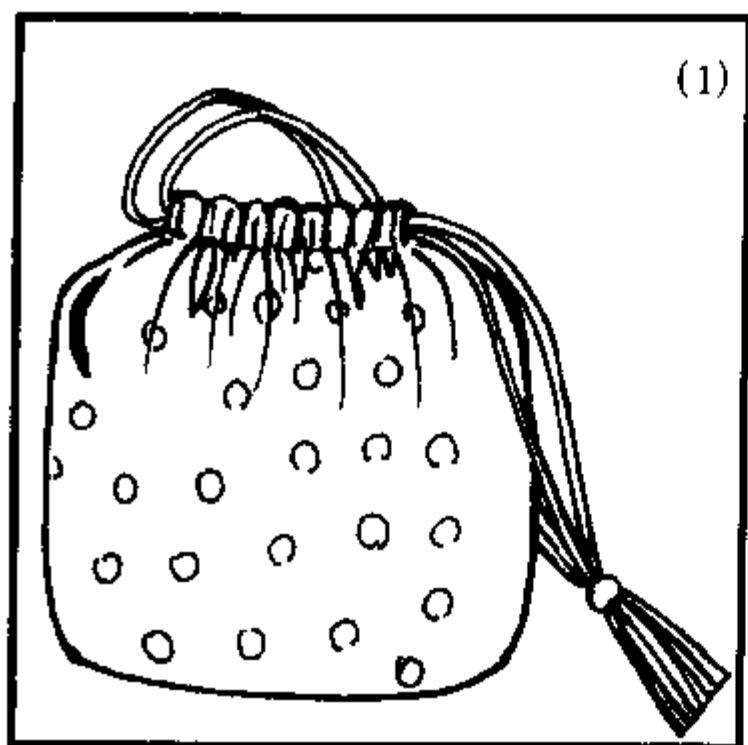

● 圆筒抽口手袋

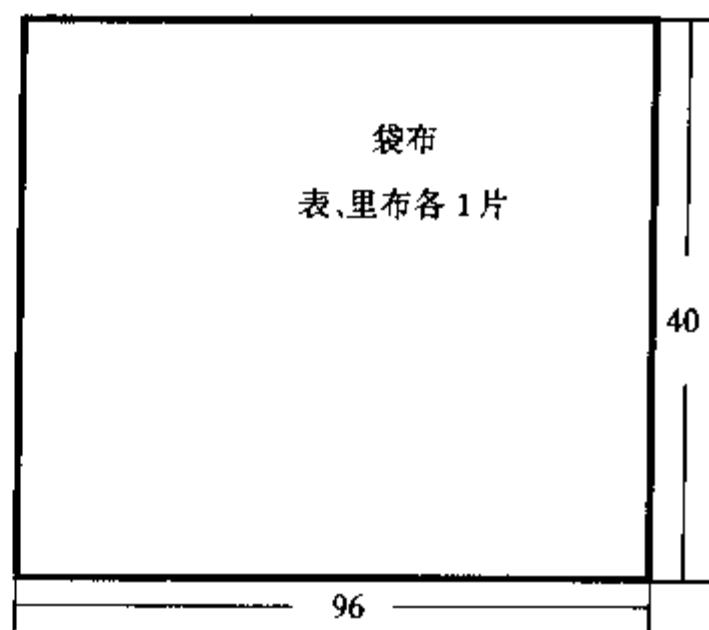

① 缝合侧缝

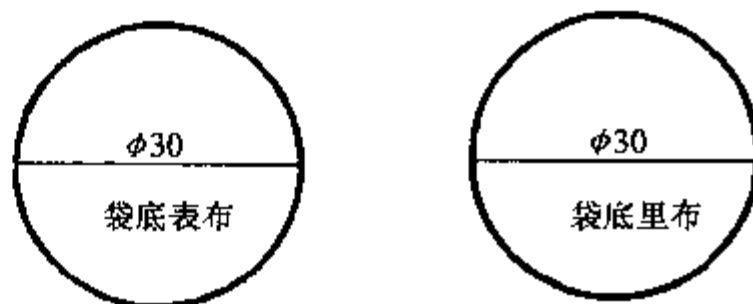
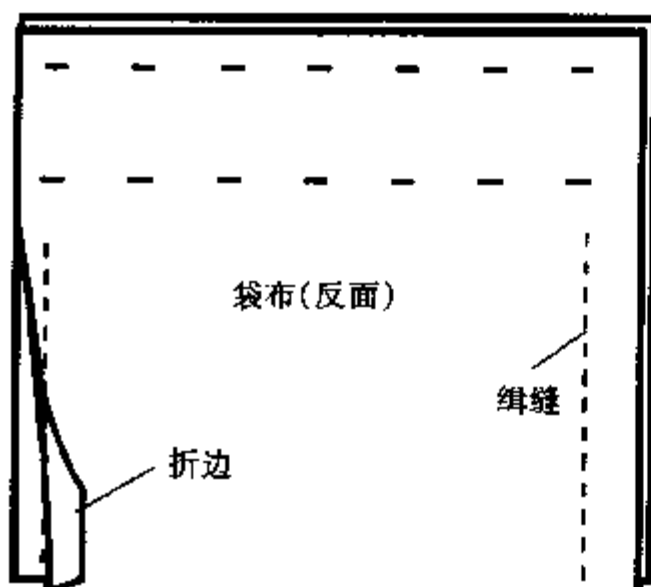

② 侧缝上端设通绳口

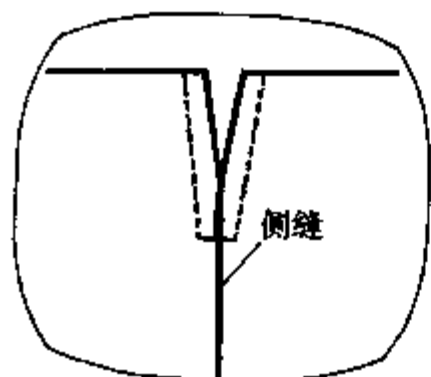

③ 袋口向内折为贴边

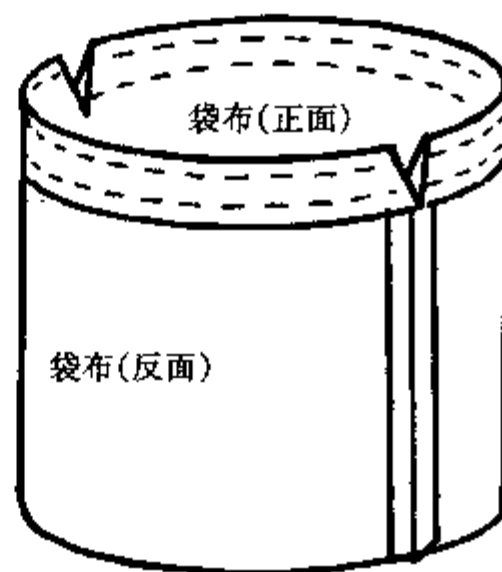

④袋底与袋布缝合

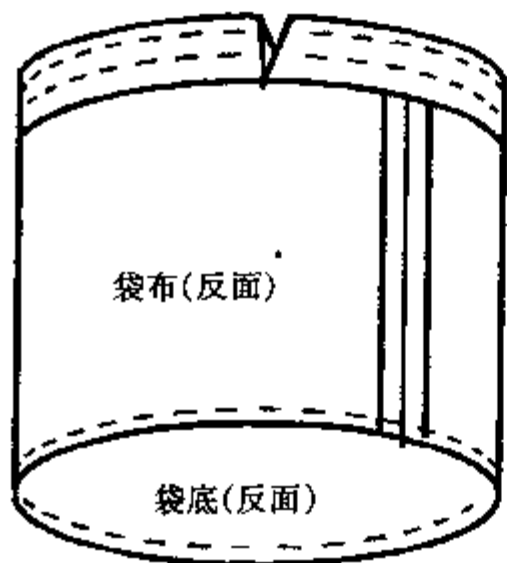

⑤缝合袋里布

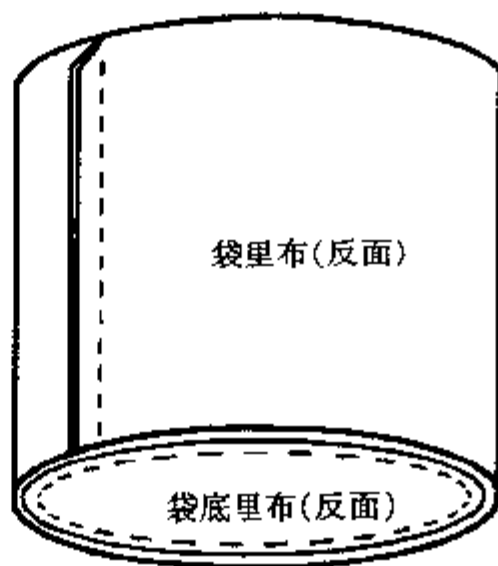

⑥袋里布与袋布贴边缝

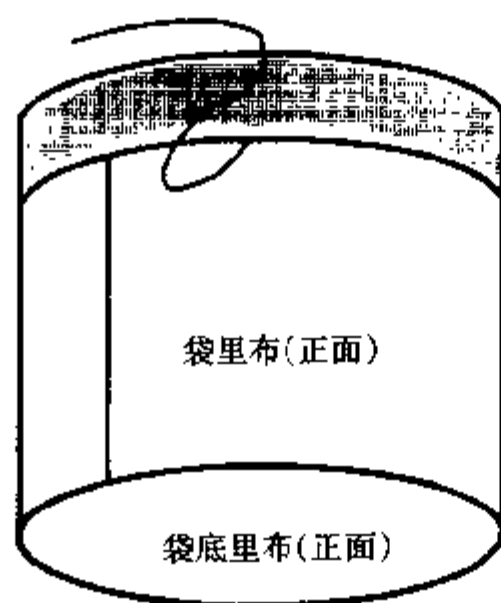

⑦将两条绳子分别穿入通绳口

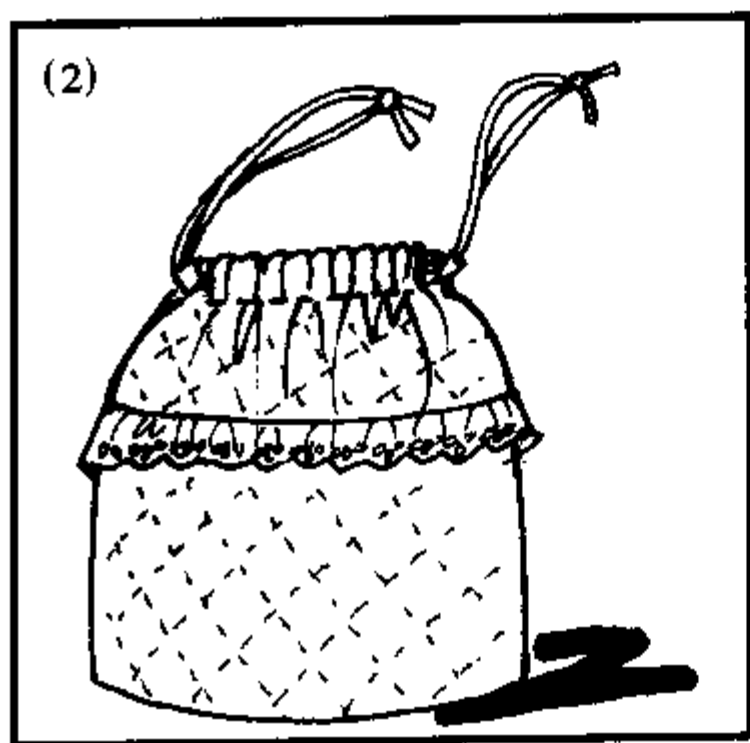
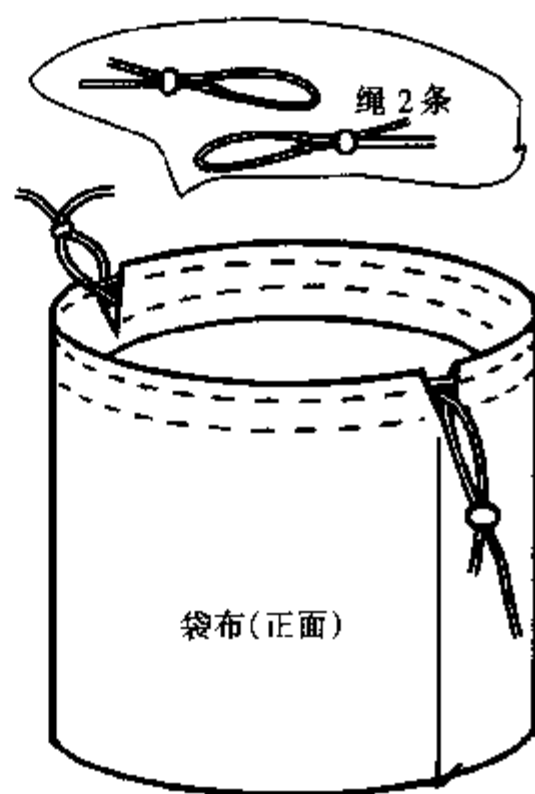

缉缝菱形图案及花边

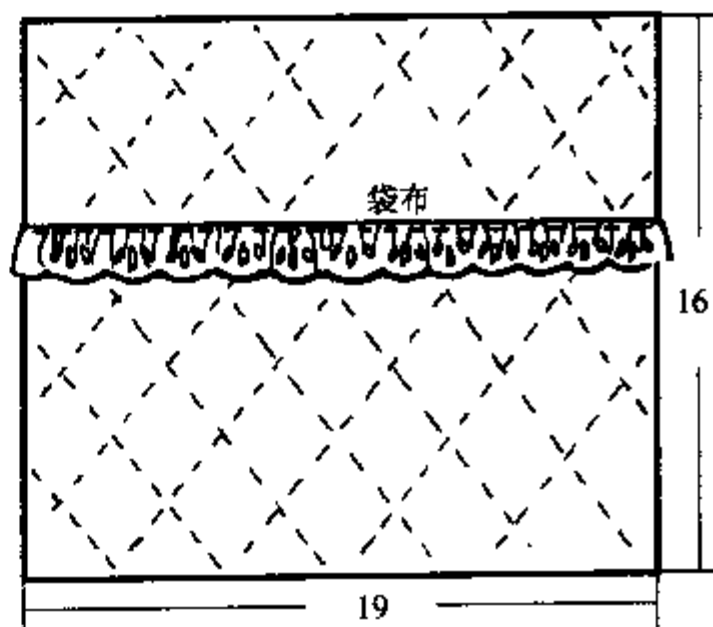

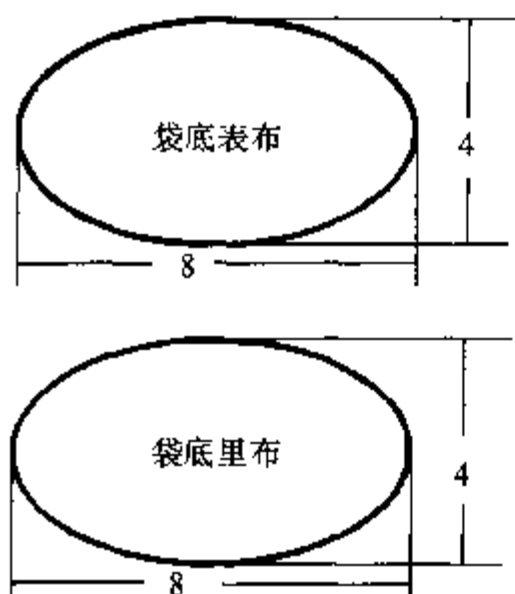

将两条绳子分别穿入通绳口

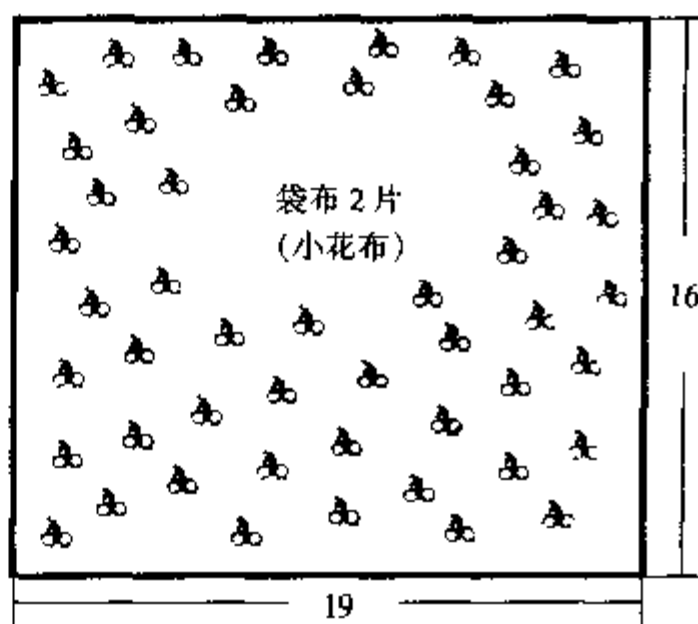
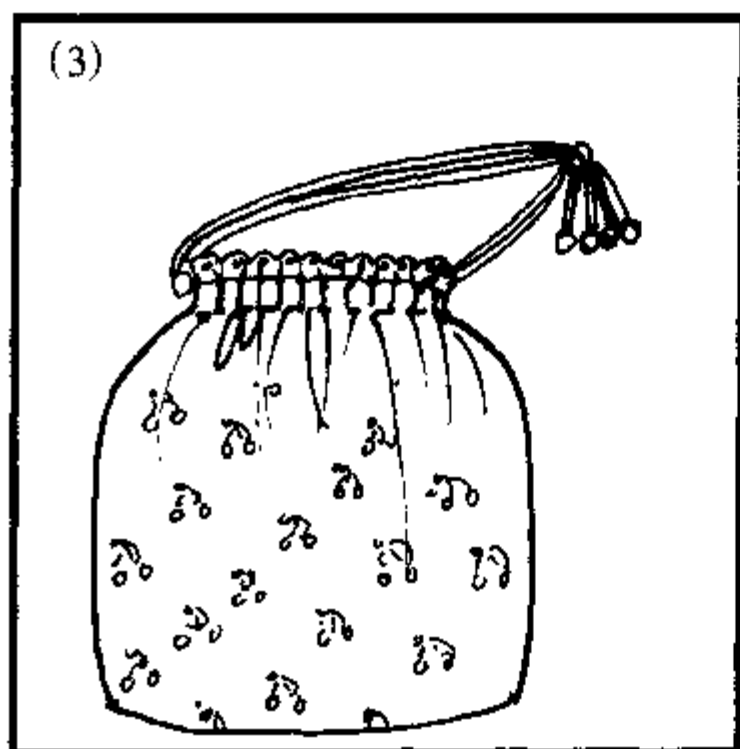

①缝合侧缝

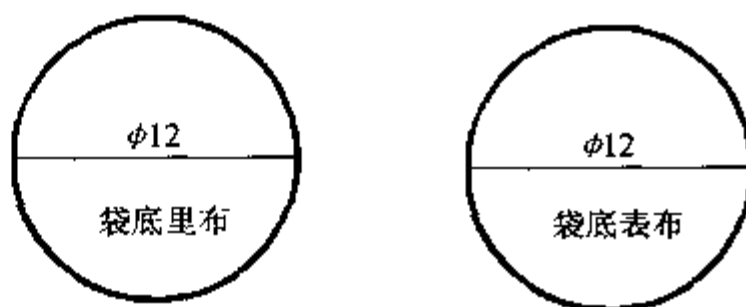
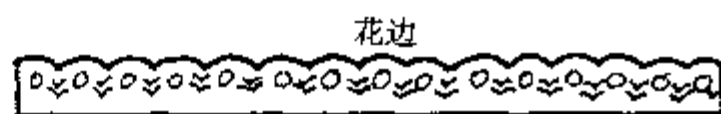
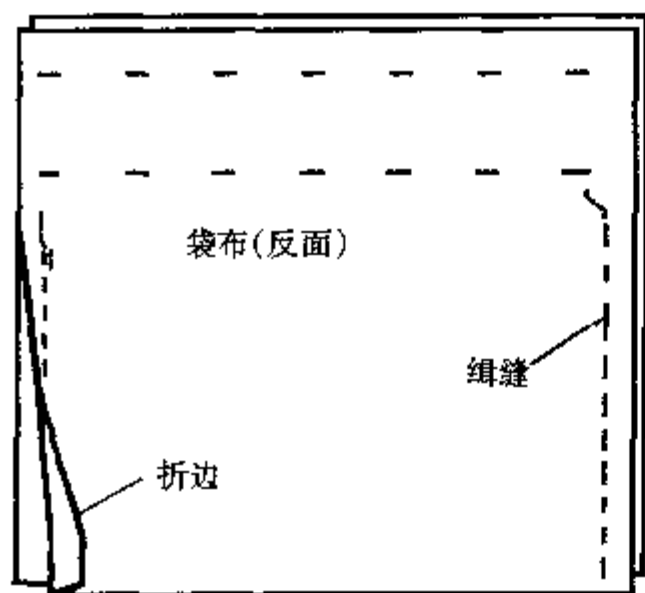

②侧缝上端设通绳口

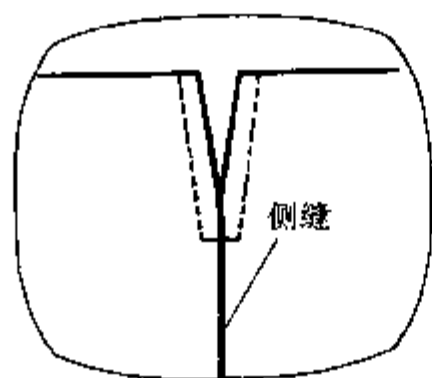

③袋口向内折为贴边

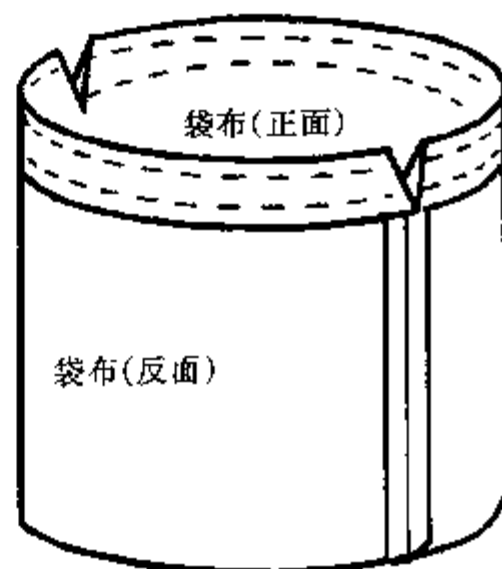

④袋底布与袋布缝合

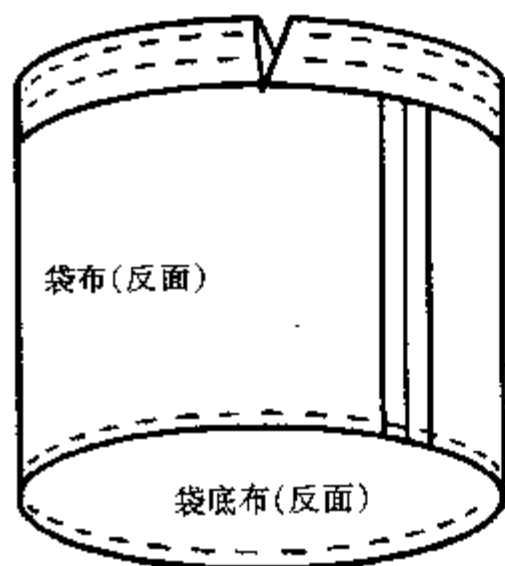

⑤缝合袋里布

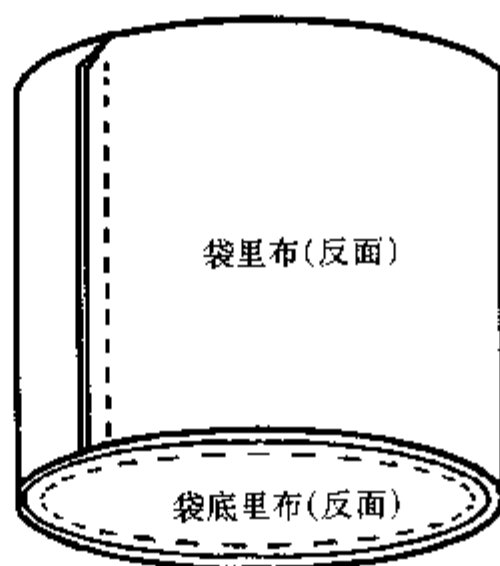

⑥袋里布与袋布贴边缲缝, 并在袋口处缝花边

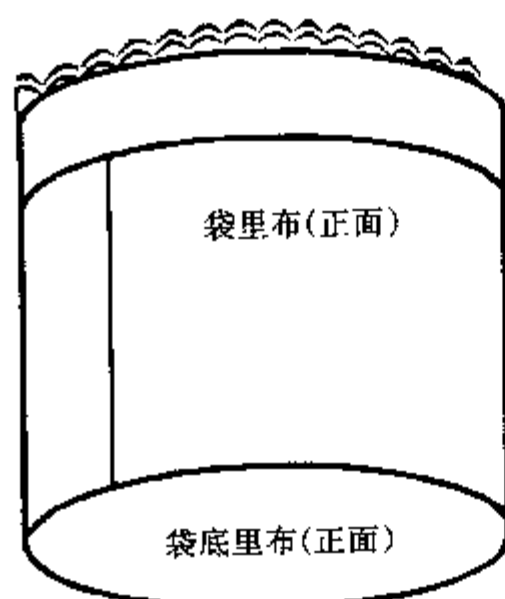

⑦将两条绳子分别穿入通绳口





●珠穗抽口手袋

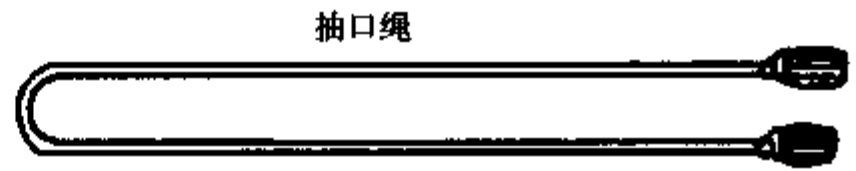
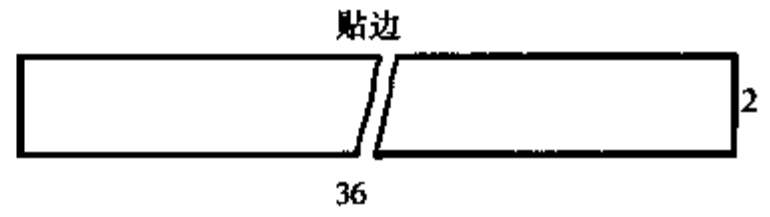
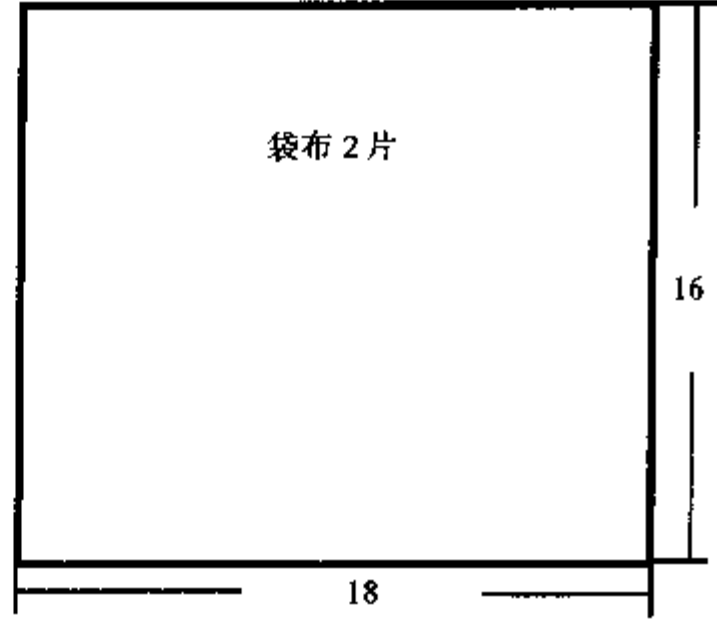

①缝合袋布侧缝

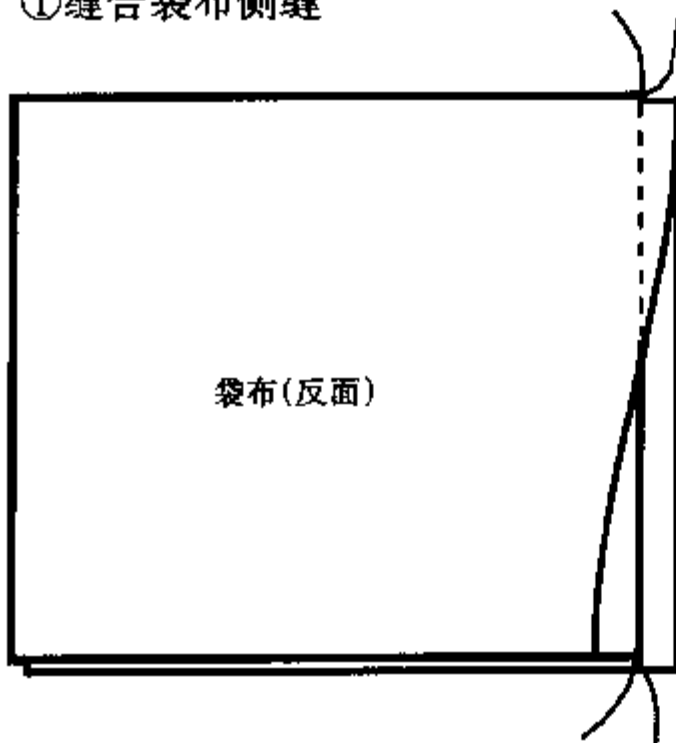

②缝合抽带侧缝

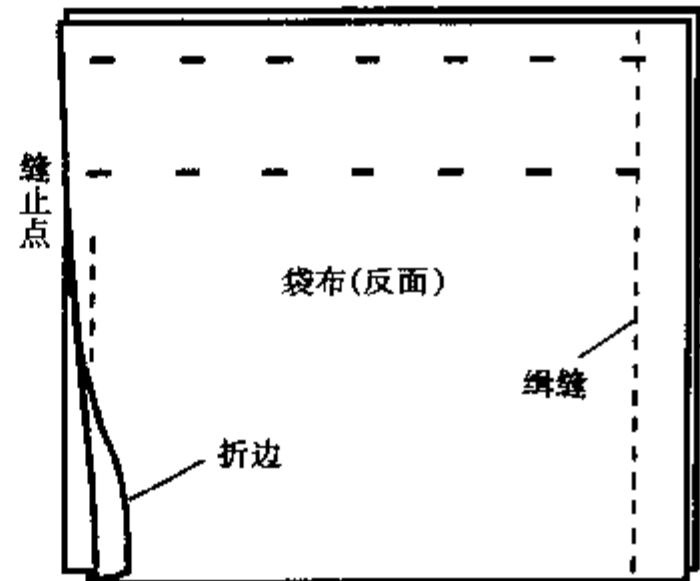

③缝合袋口贴边并夹缝花边

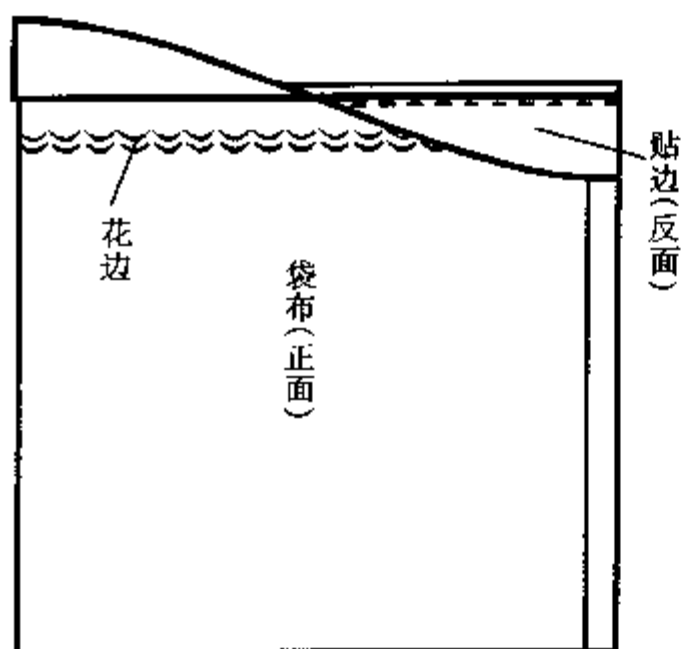

⑤袋口串绳

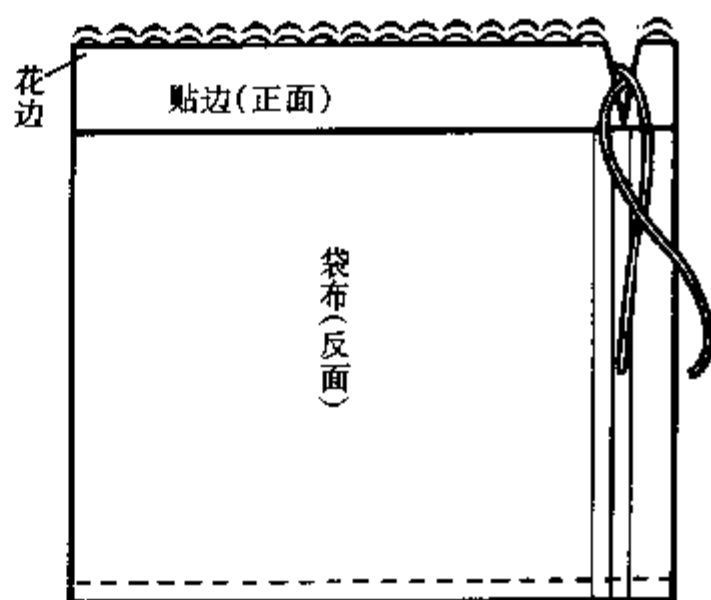

④缝合袋底

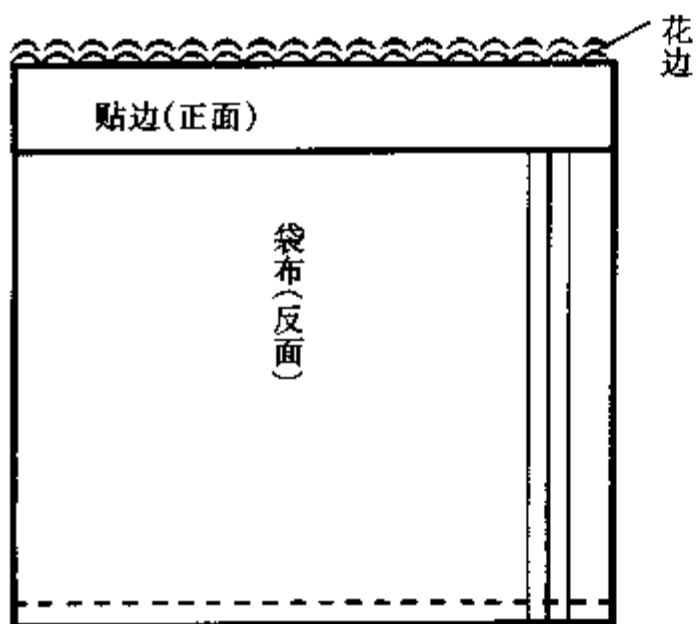

⑥袋底钉缝珠穗

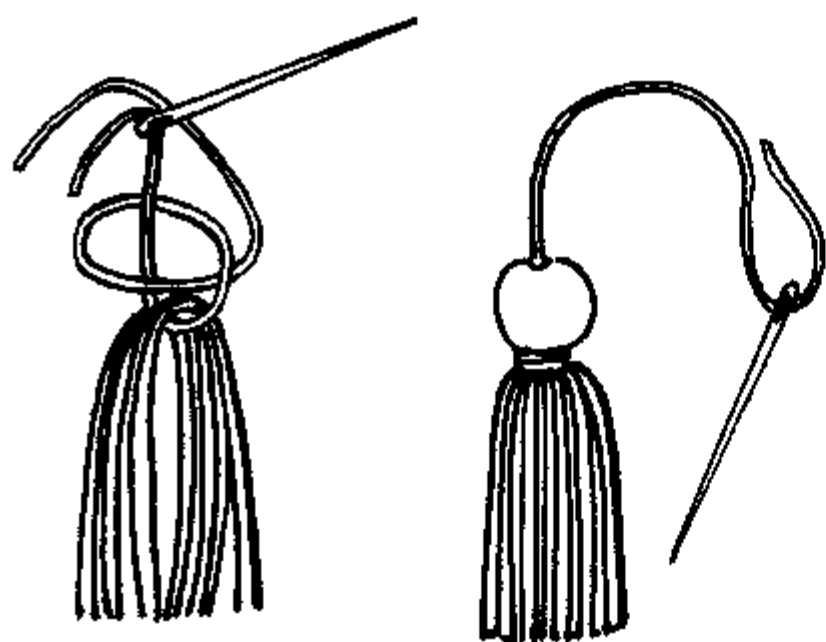
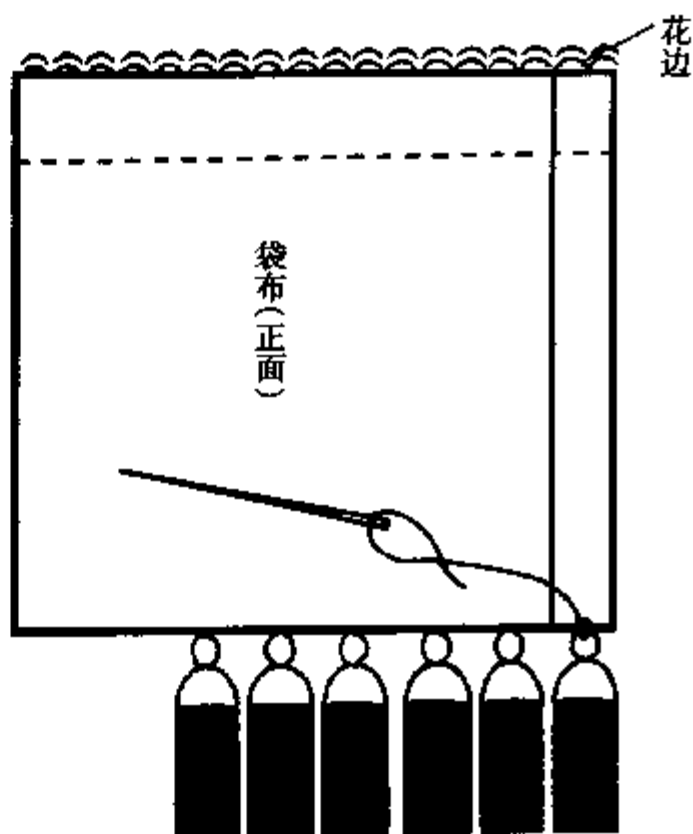

多用装饰挂袋的制作

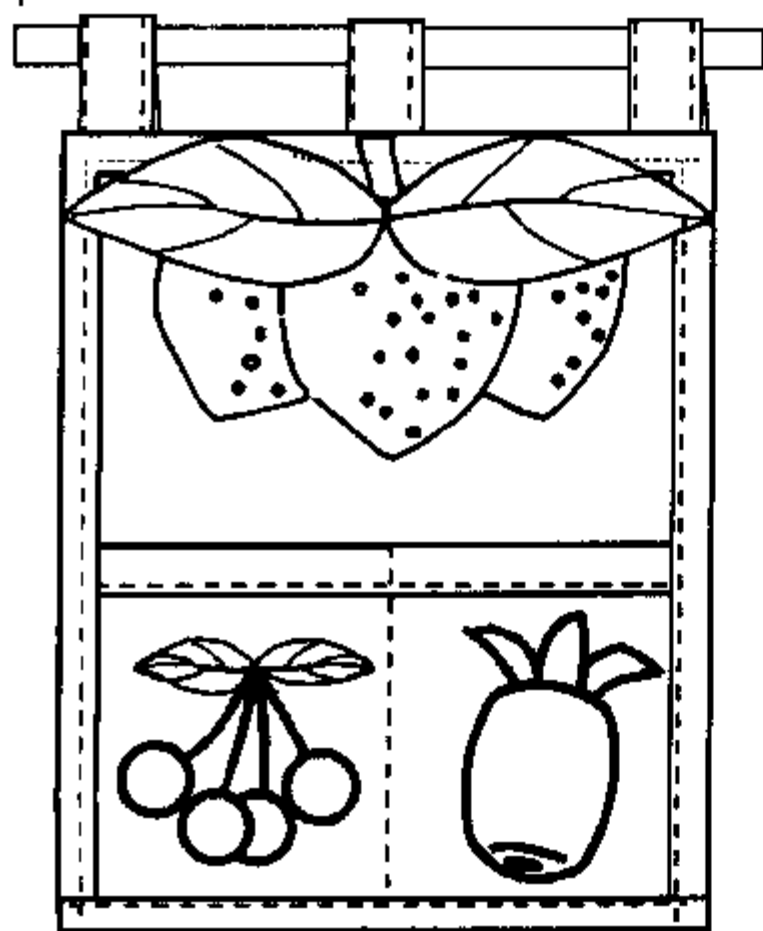

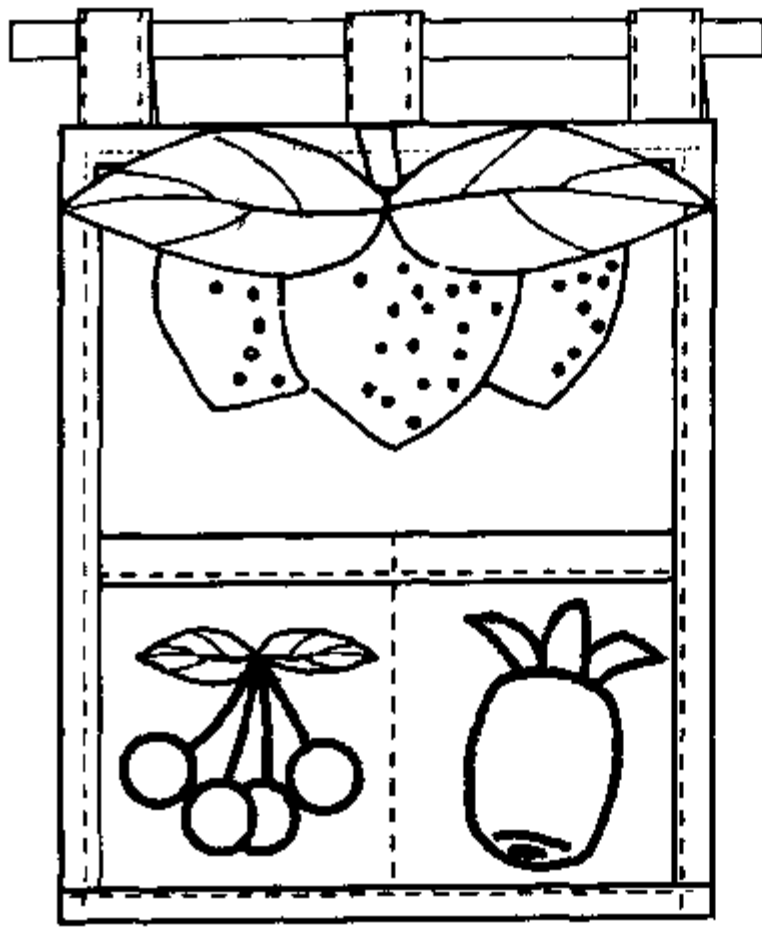

●补花双兜挂袋

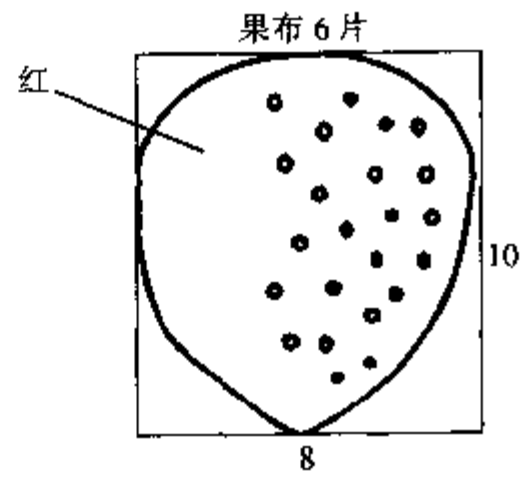
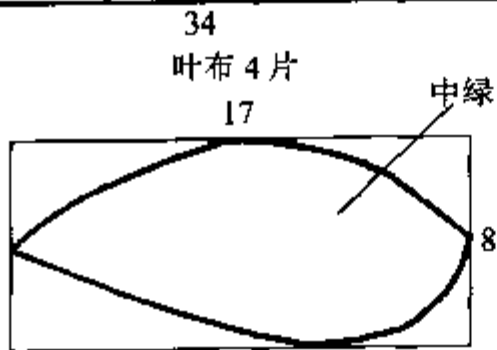
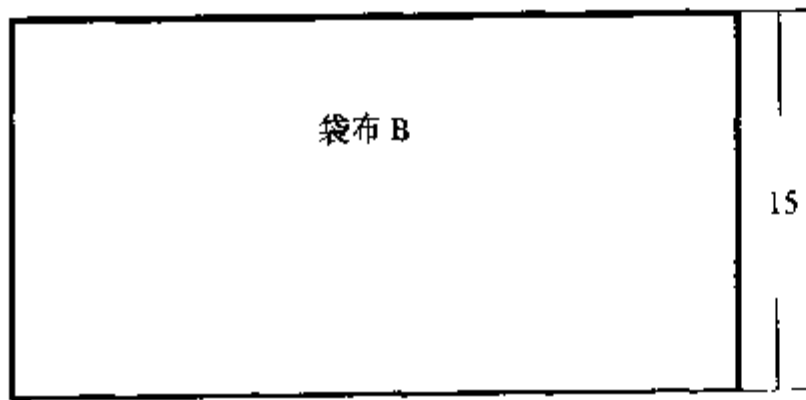
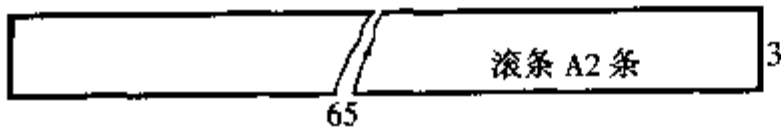
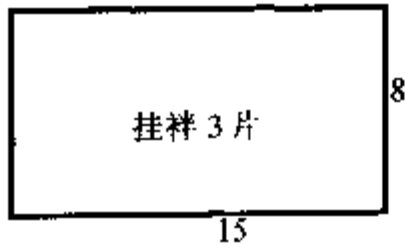
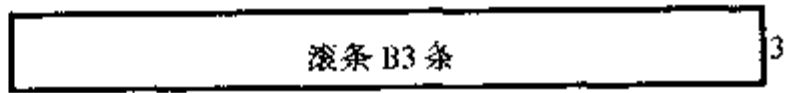
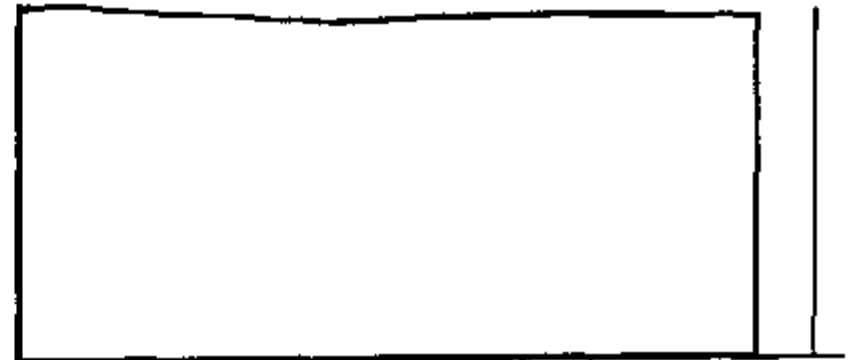
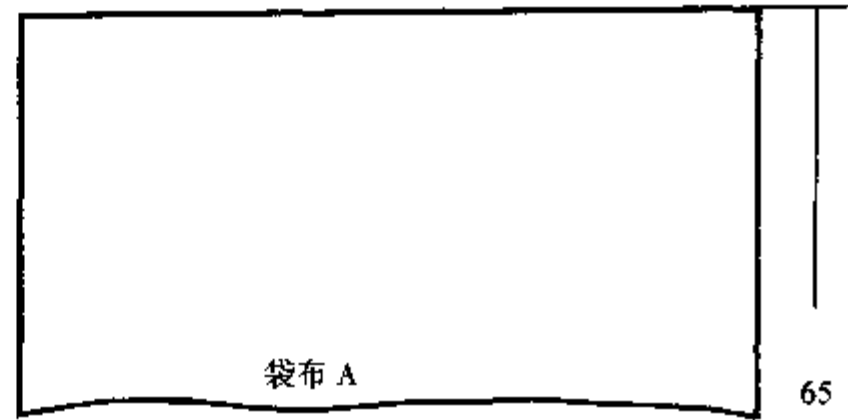

①叶的制作

a. 填充料

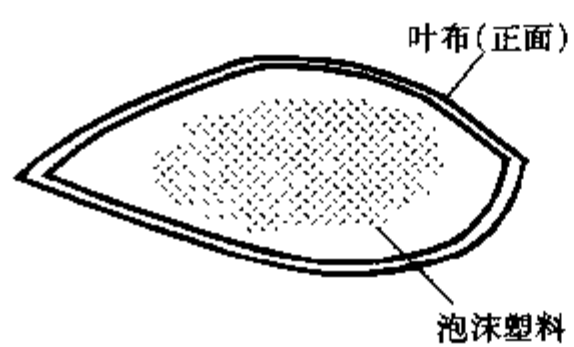

b. 折边及熨烫

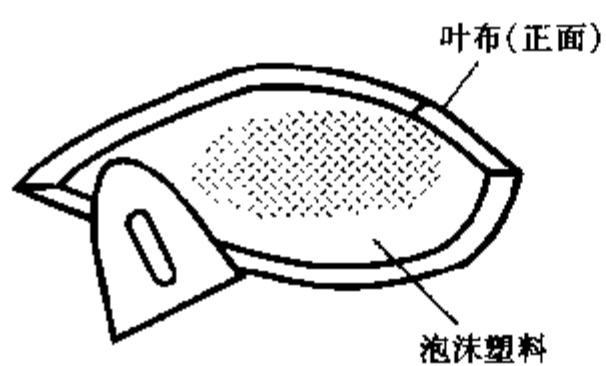

②草莓的制作

a. 填充料

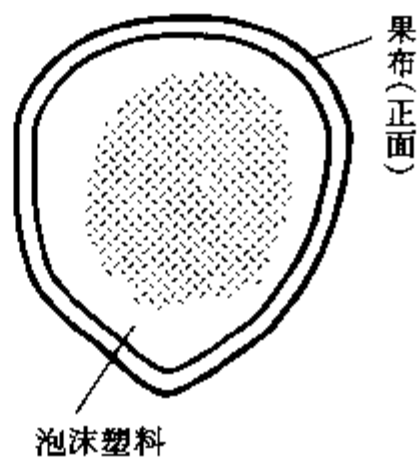

b. 折边及熨烫

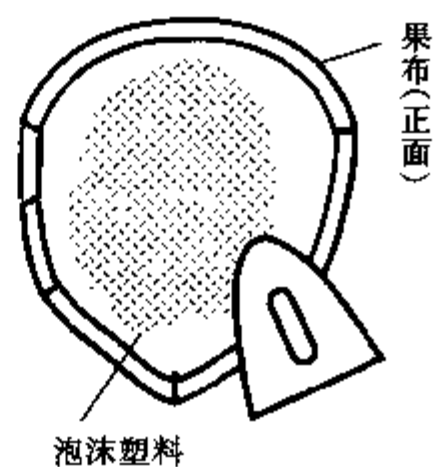

③制作袋布 B 上的装饰物 (剪布贴缝)

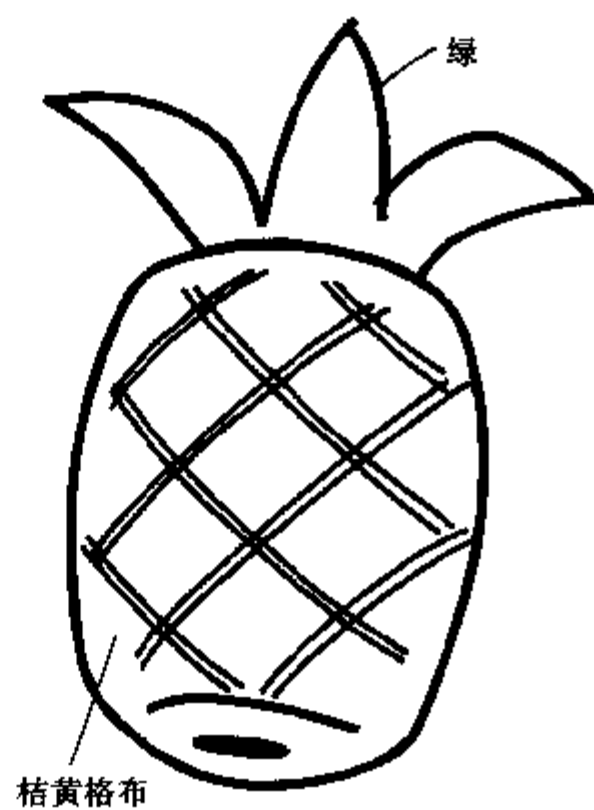
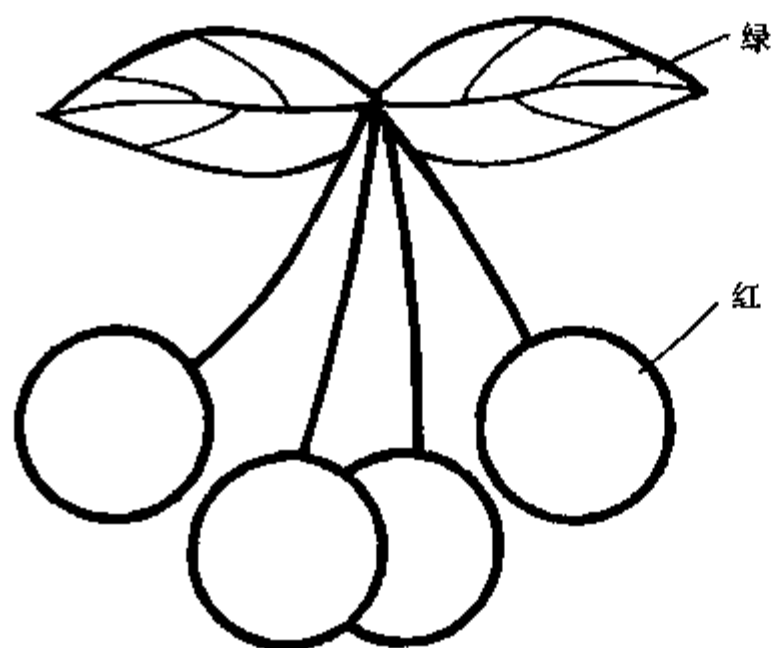

④沿袋布 B 上口边

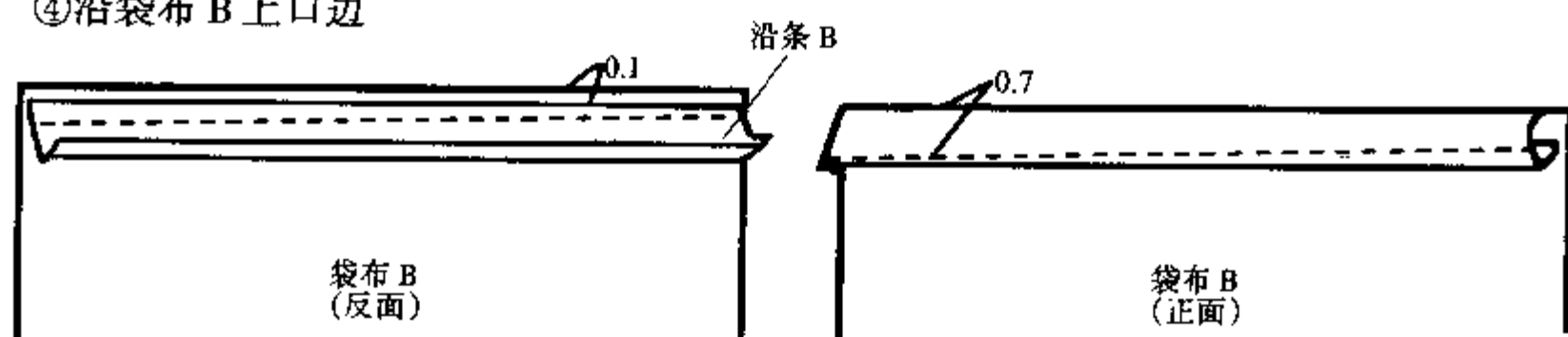

⑤手针繅缝装饰物

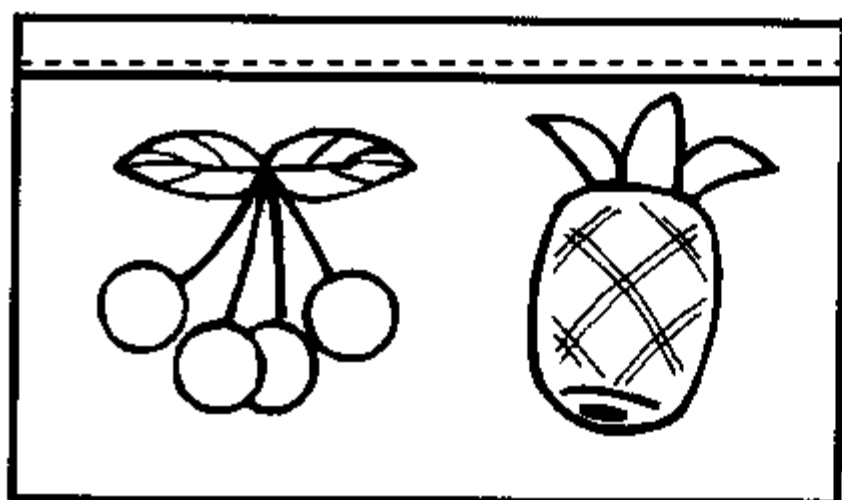

⑥缝合袋布 A 与袋布 B

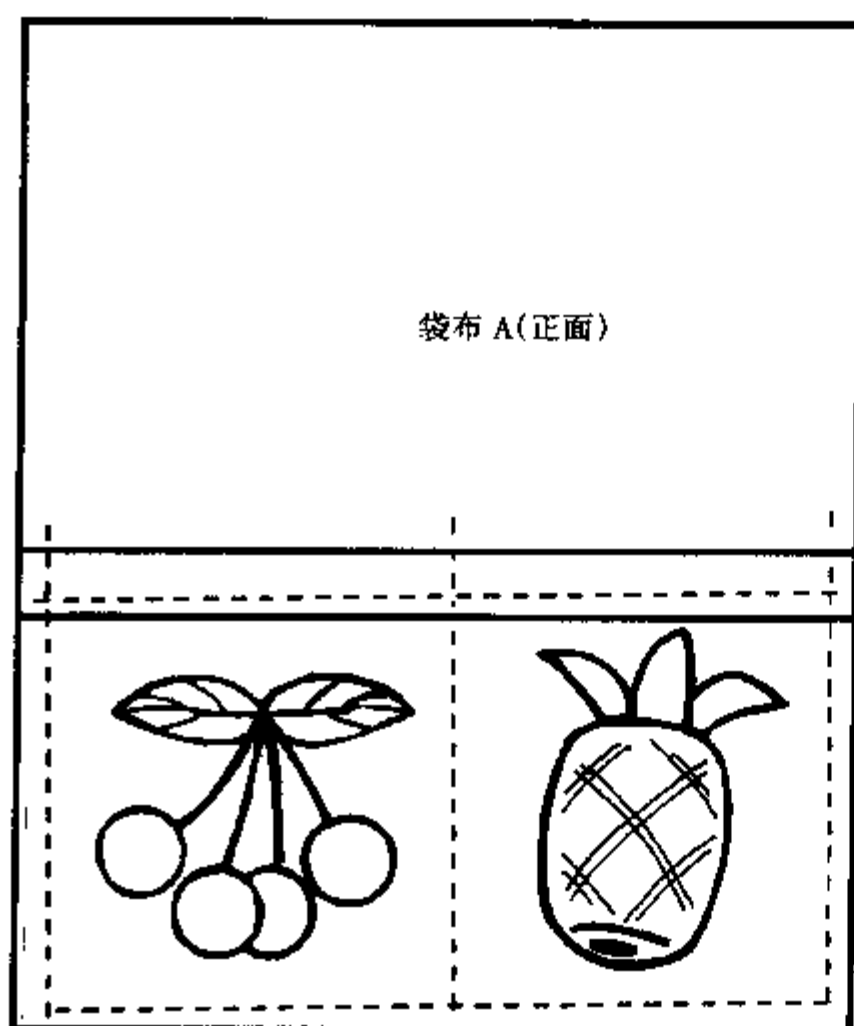

⑦滚边

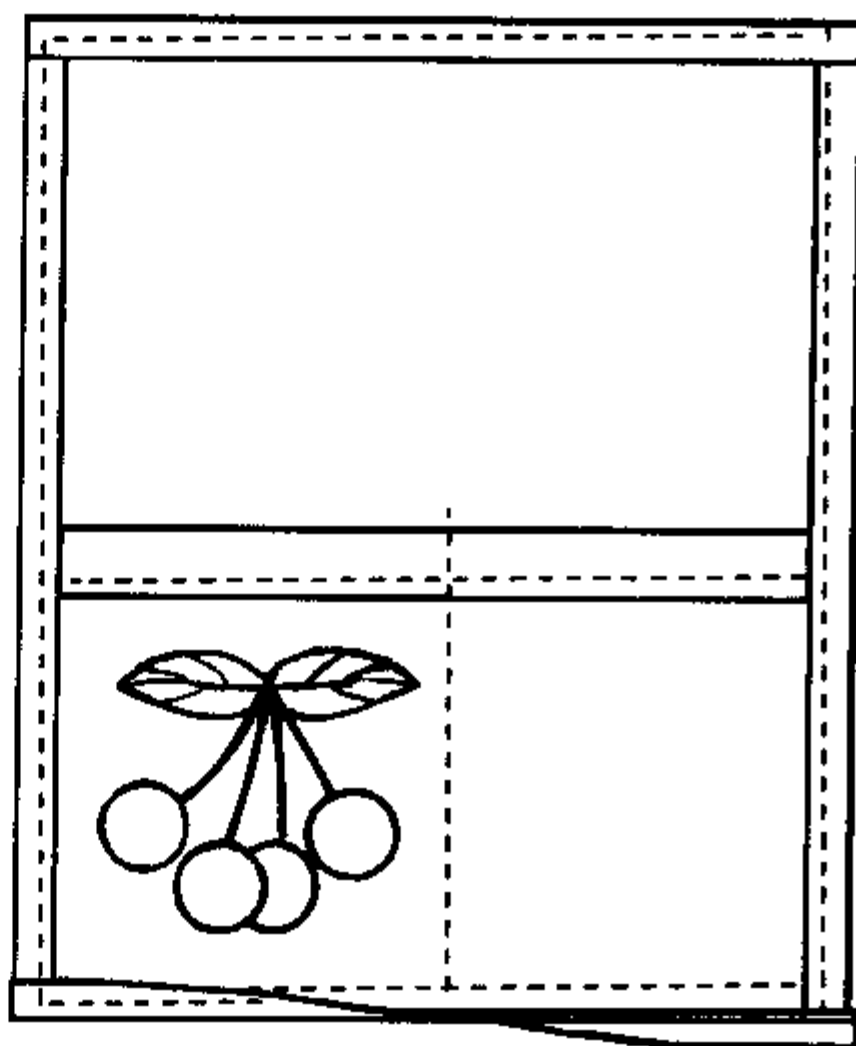

⑧缝合两侧挂袂

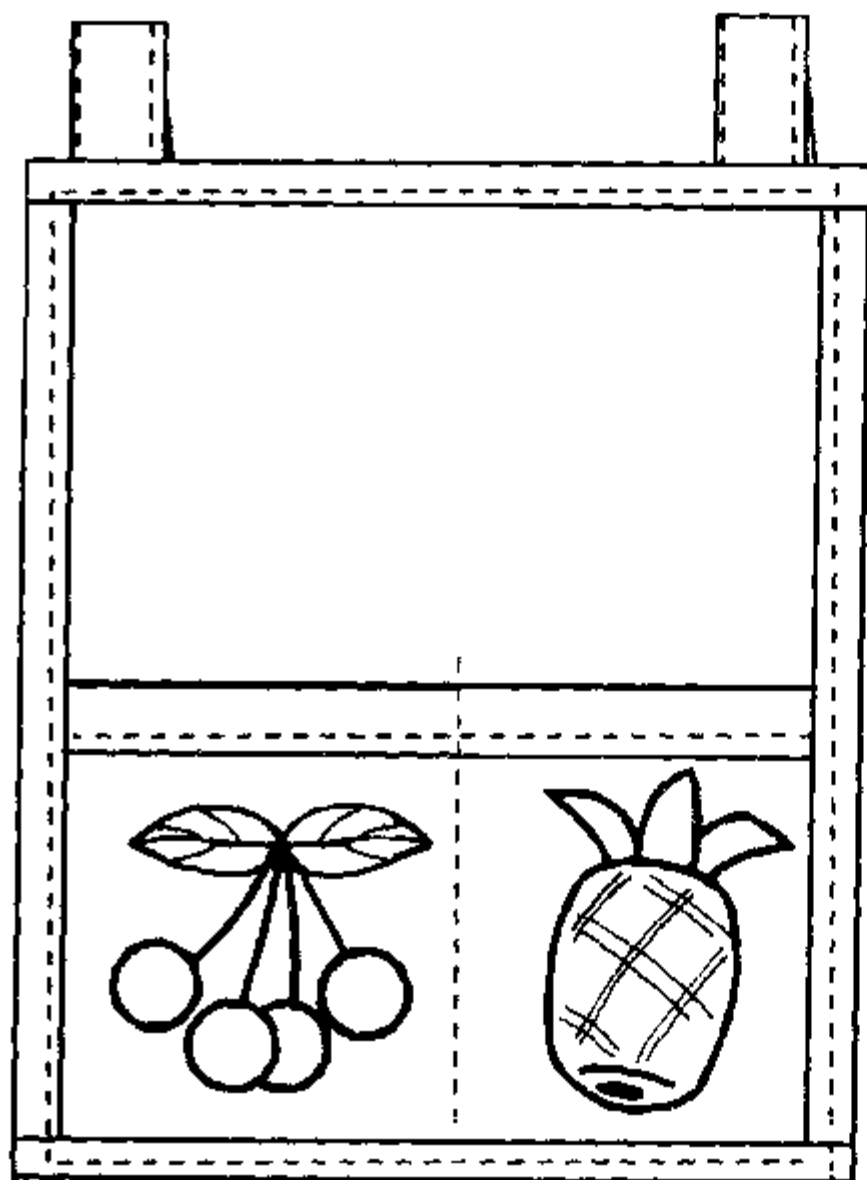

⑨组合固定装饰草莓(粘贴)

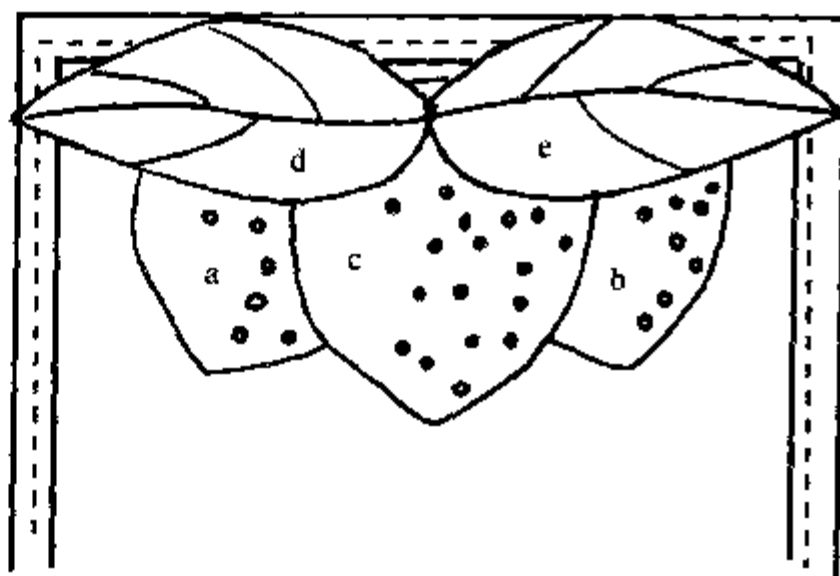

⑩缝合中心挂袂及果蒂

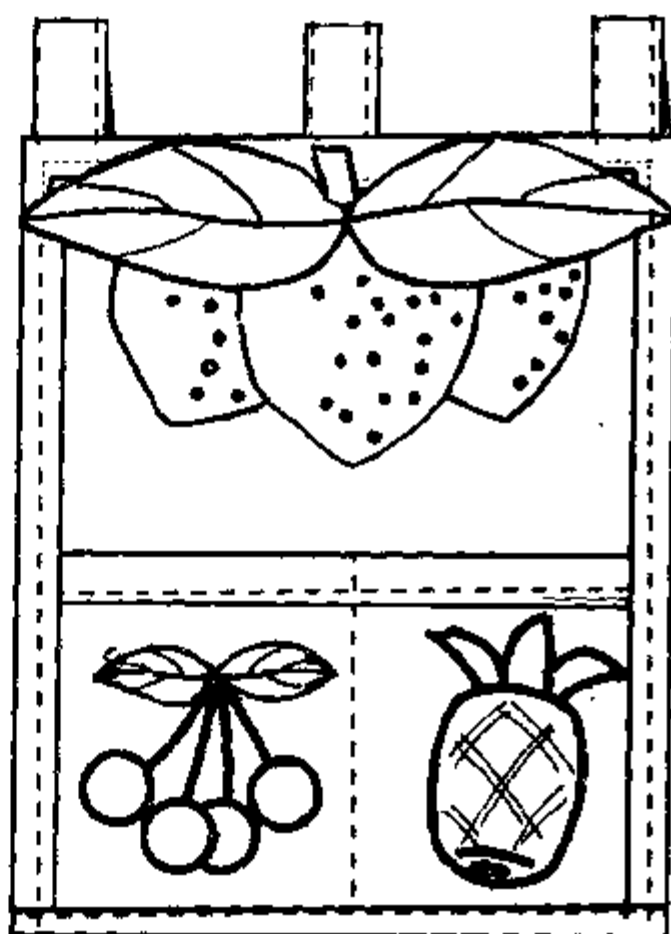

⑩手针线缝装饰草莓

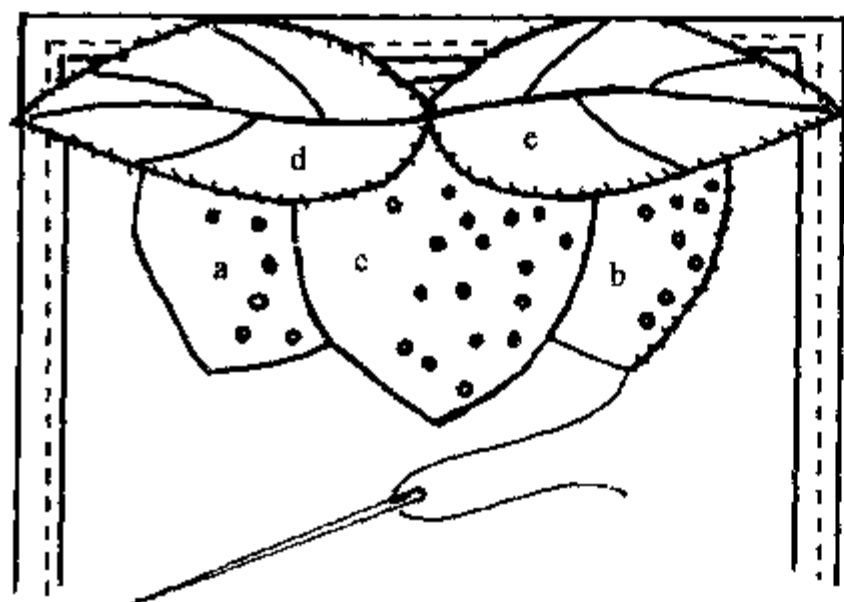

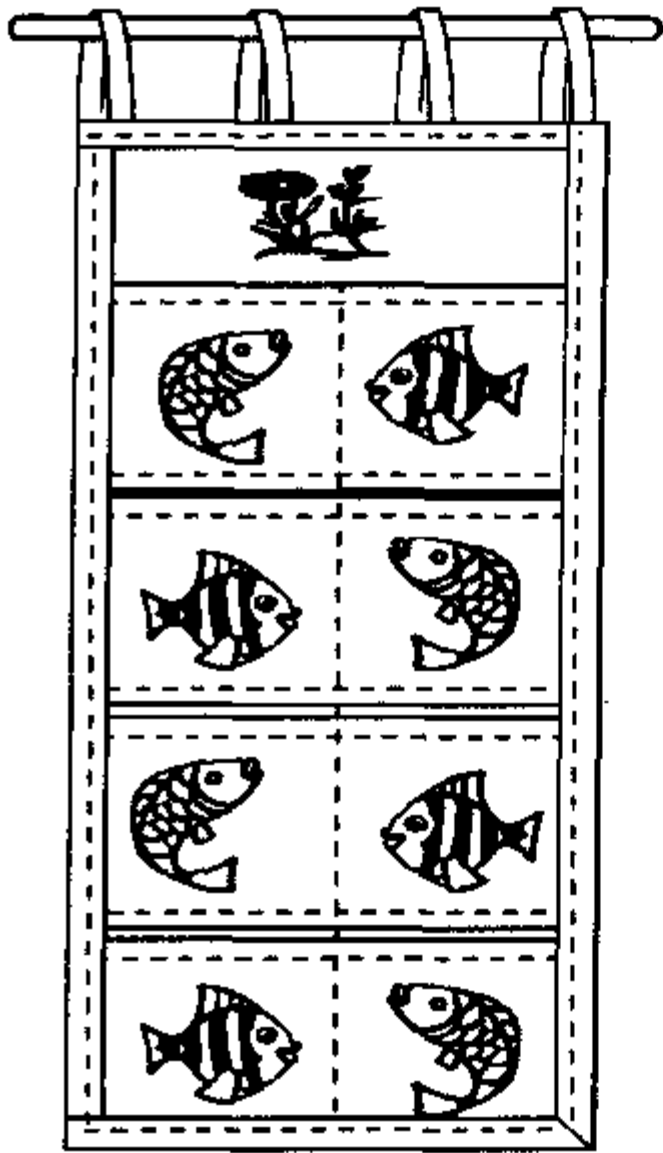

● 多用鱼纹挂袋

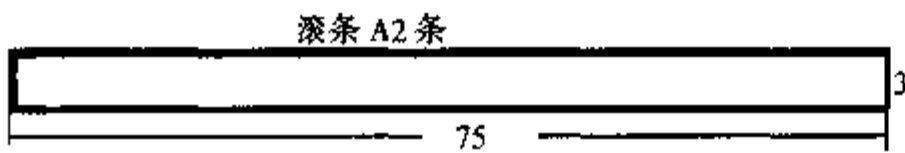
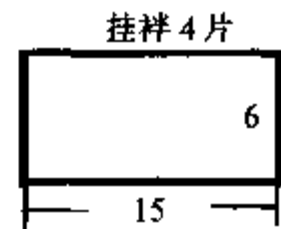
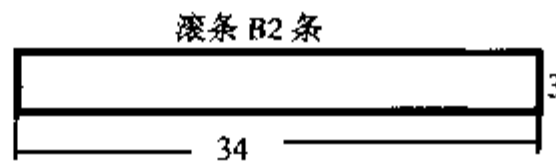
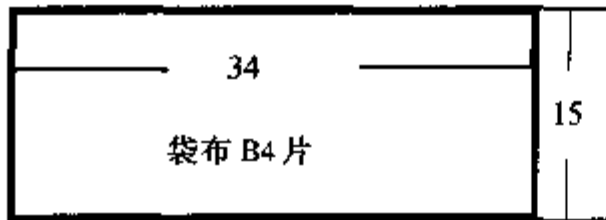
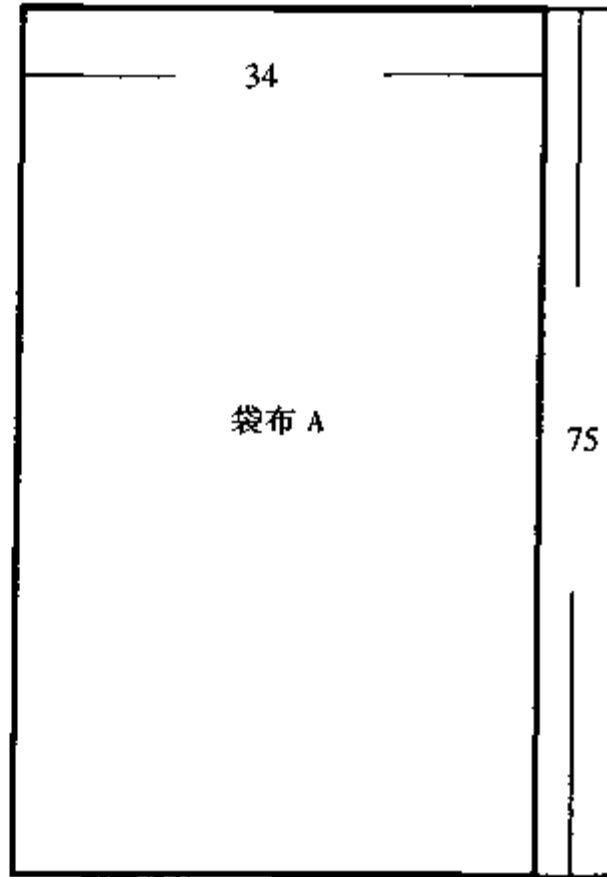

①折边

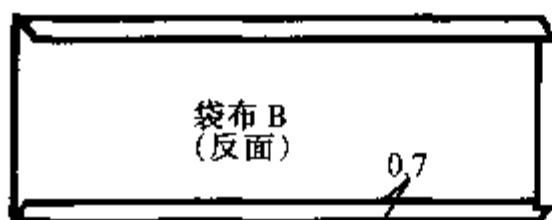

②缉缝袋布 B

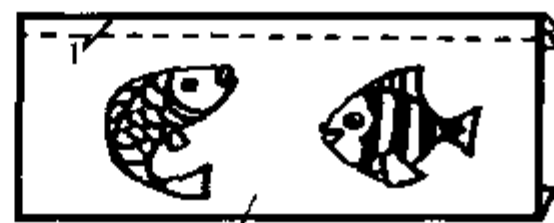

袋布 B(正面)

③缝合袋布 A 与袋布 B

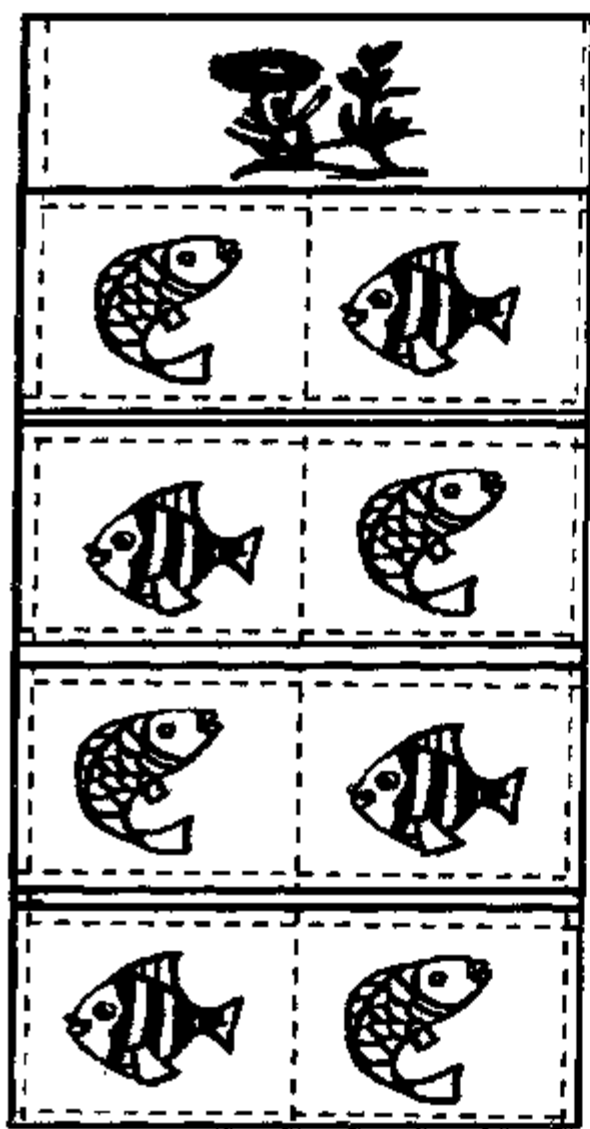

④滚条折边

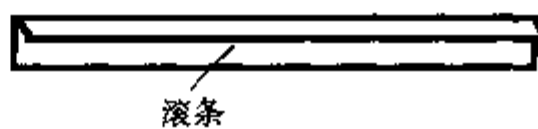

⑤袋布滚边

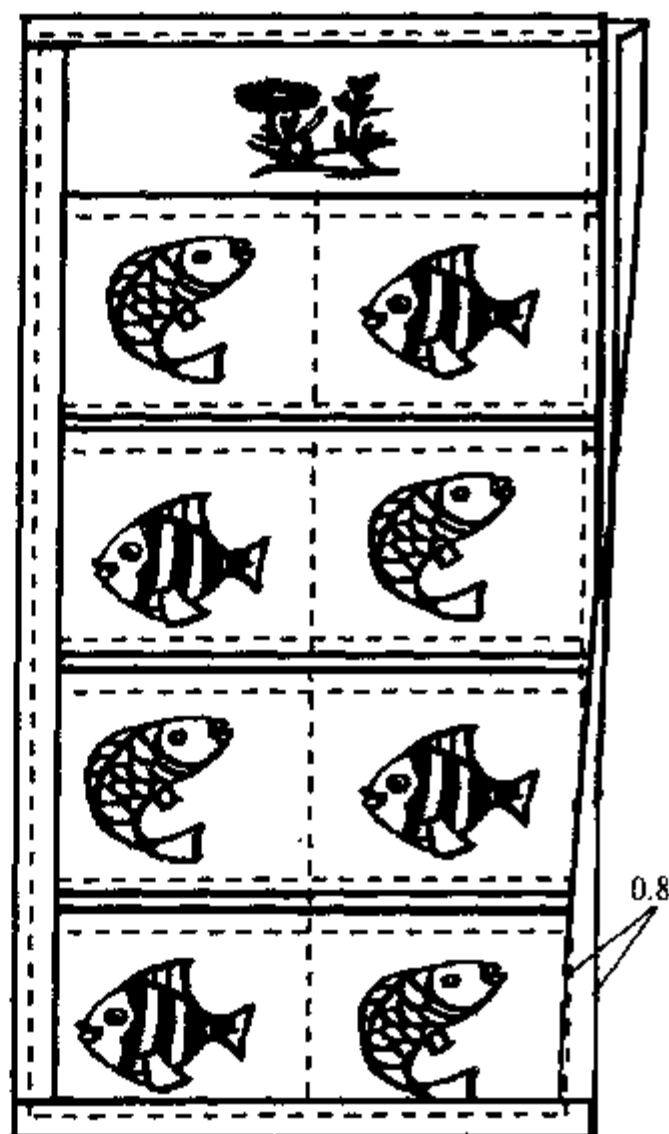

⑥制作挂袷

a. 折边

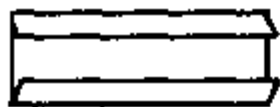

b. 对折



c. 缉缝



⑦缝合挂袷

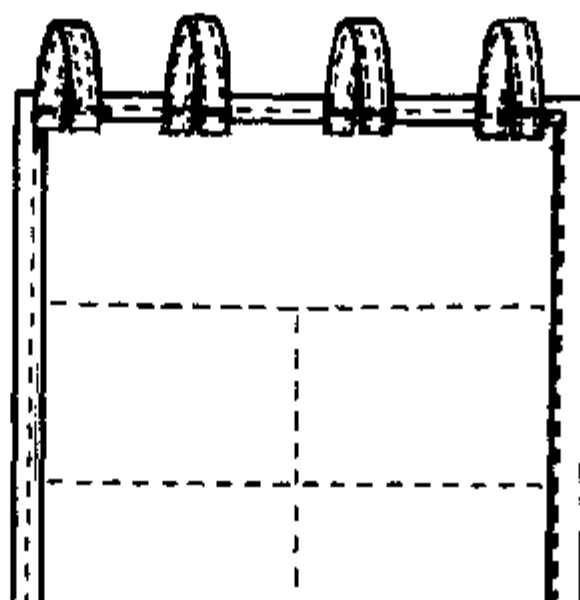

● 房形装饰挂袋

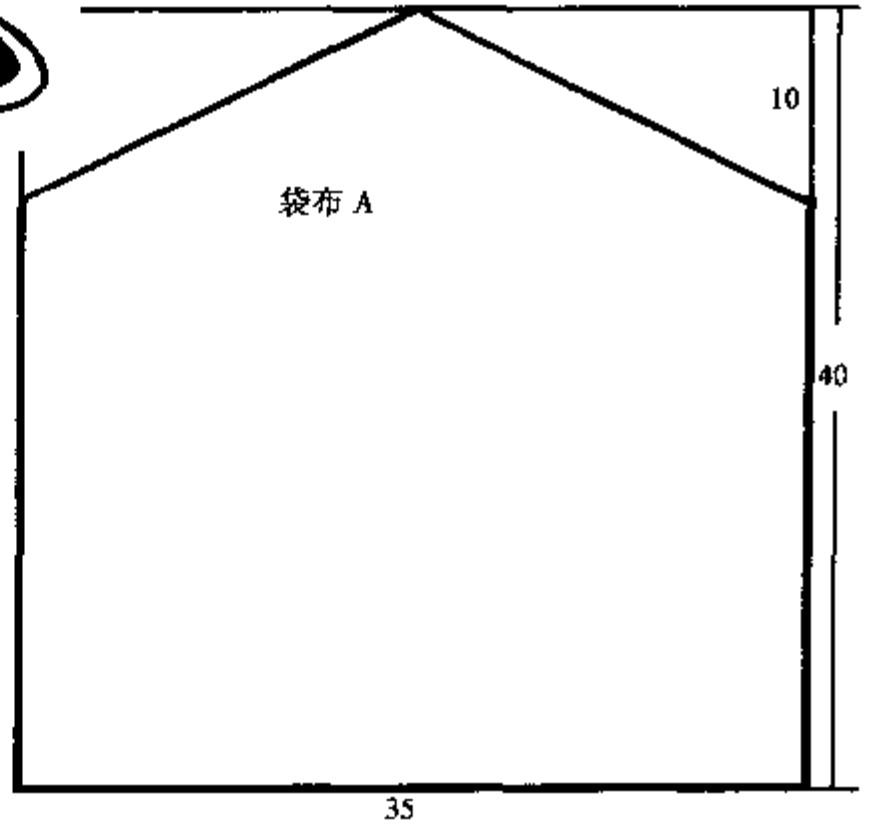

① 缝制装饰房檐

a. 缝合两片装饰布并加填充料

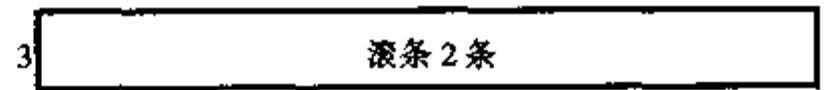
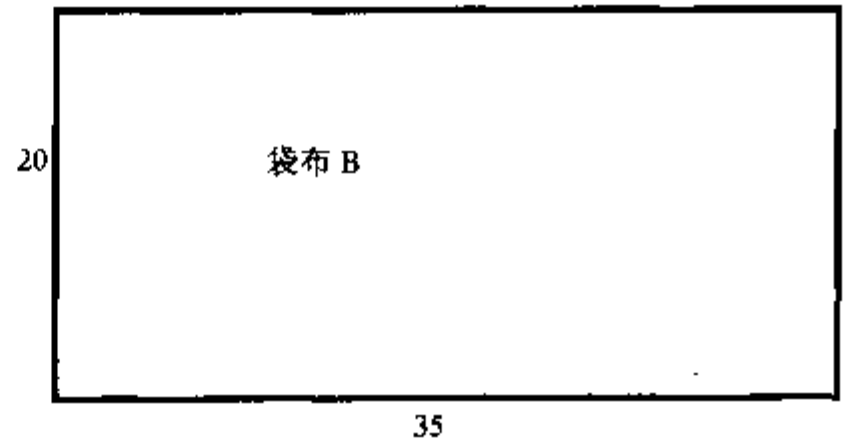
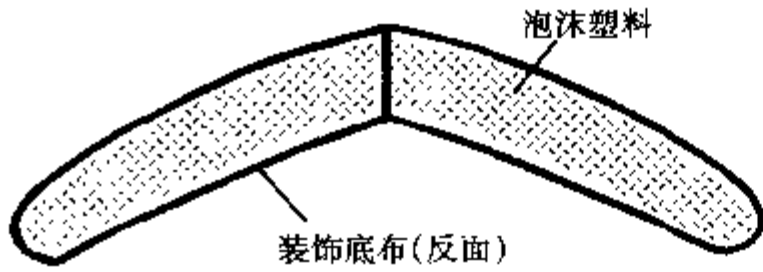

b. 装饰布正面相对缝合

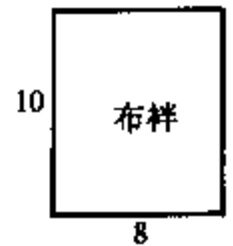
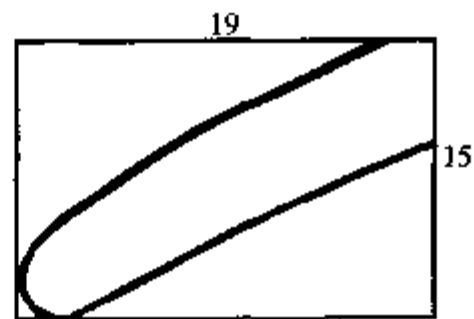
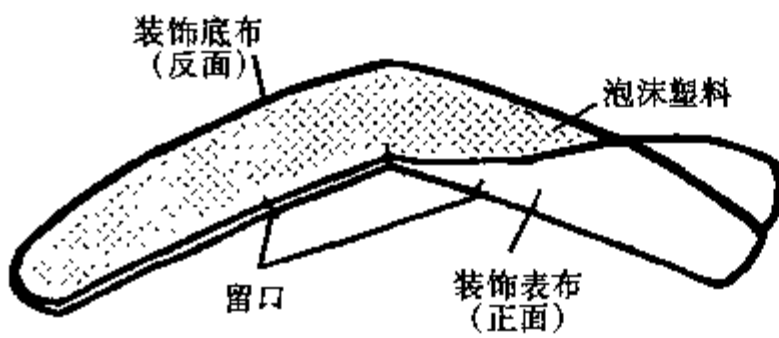

装饰房檐 4片

c. 翻至正面, 手针线缝

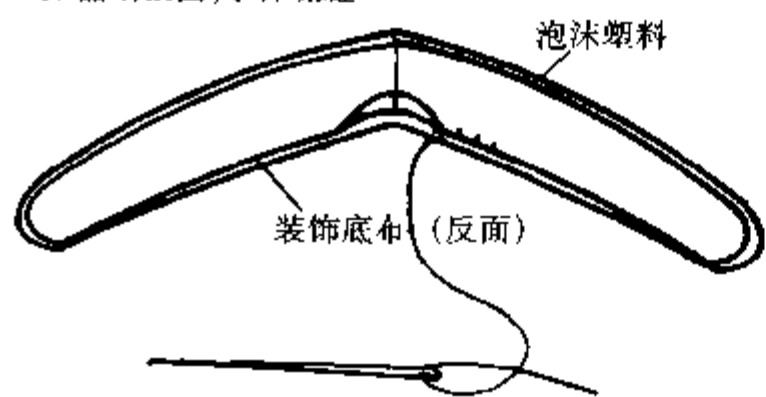

② 线缝袋布 A 与袋布 B 上的装饰图案

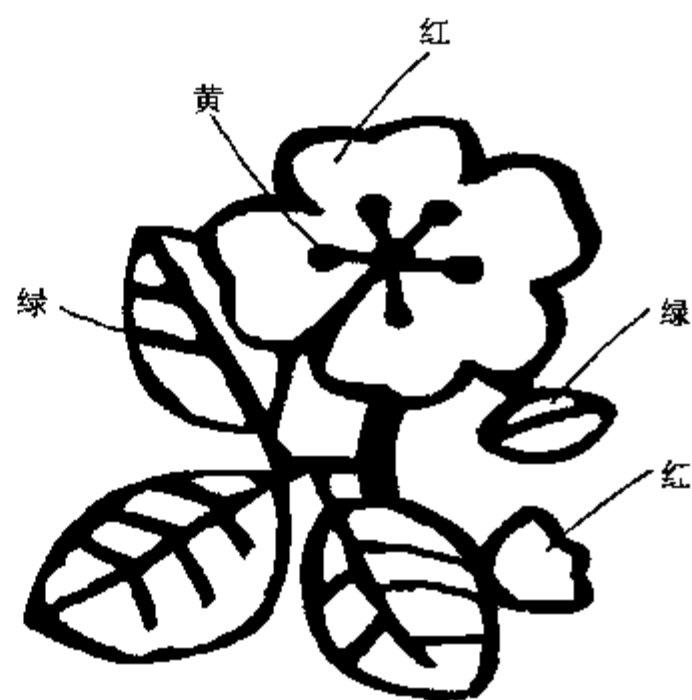
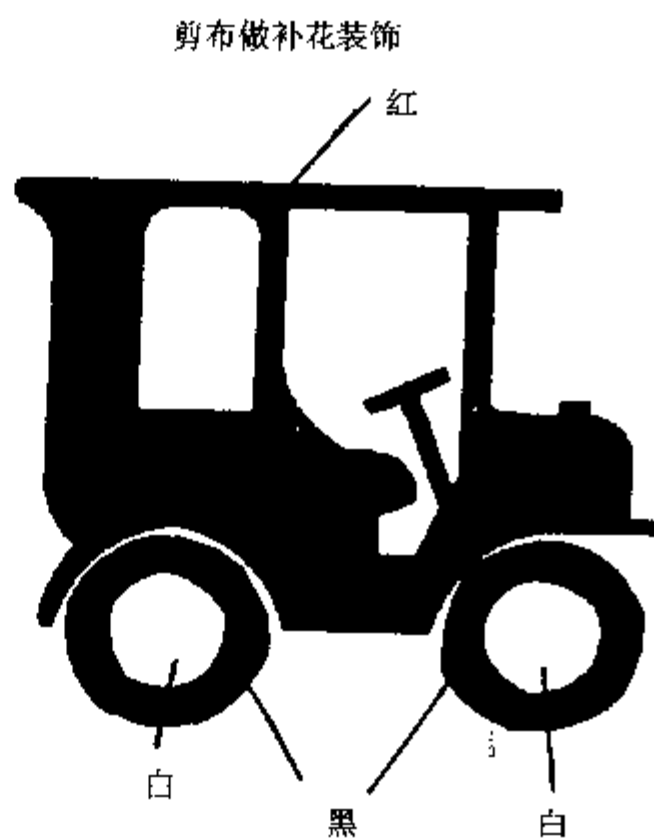
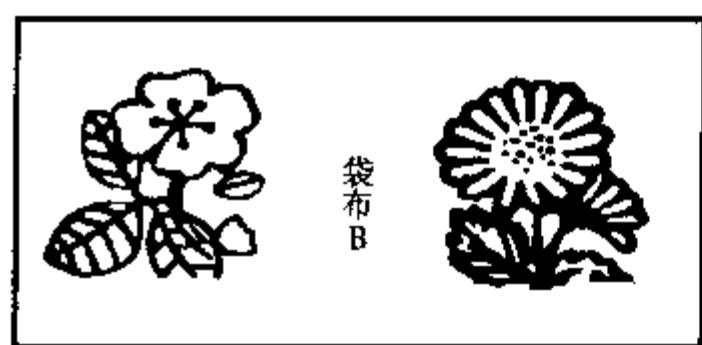
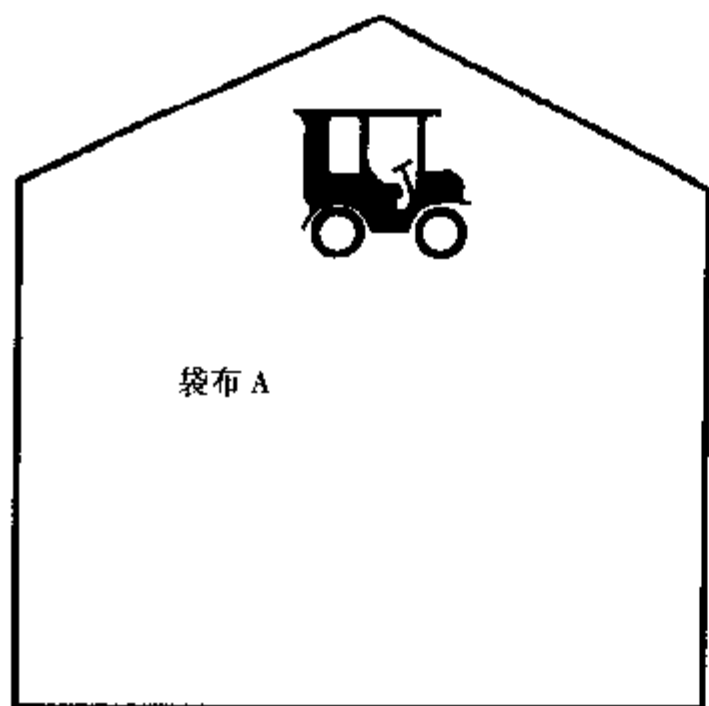

③ 沿边

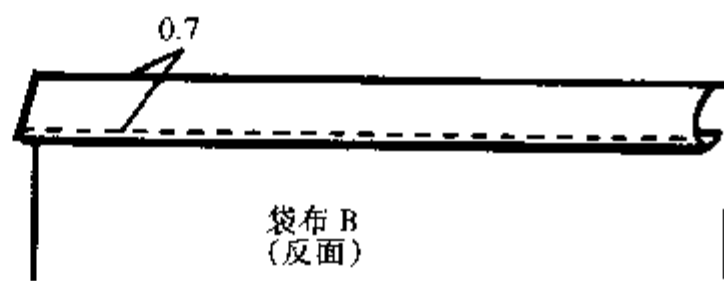
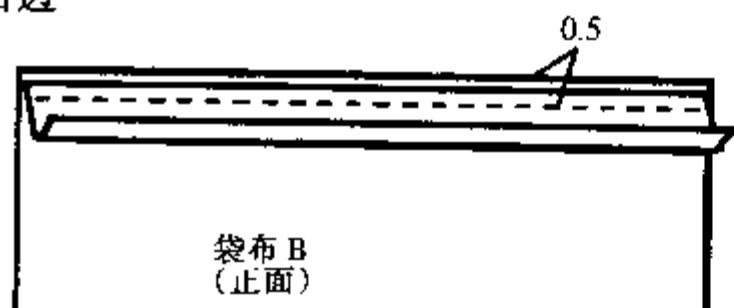

④缝合袋布 A 与袋布 B

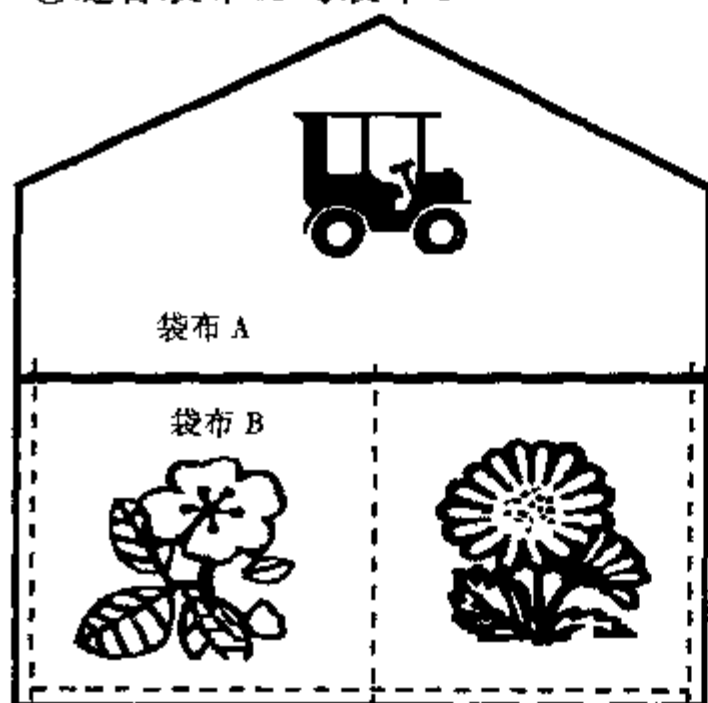

⑥滚边

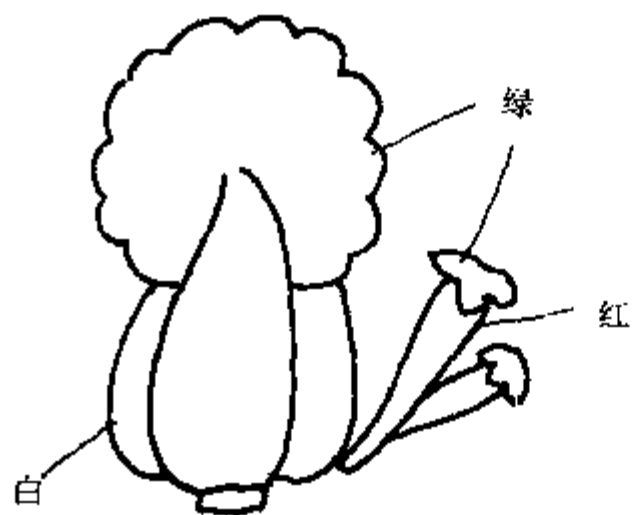
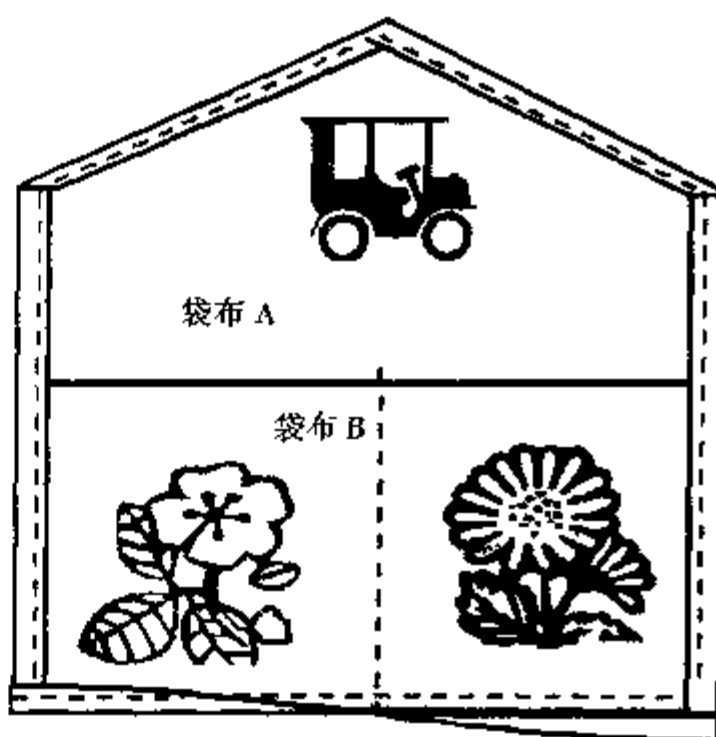

可任意选择的装饰图案

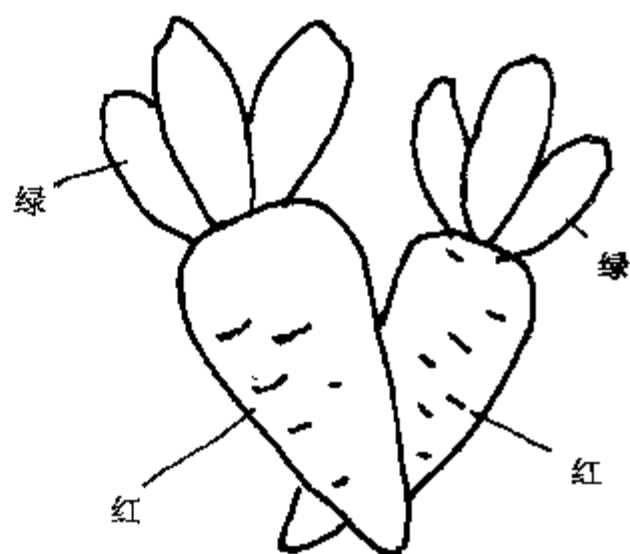

⑤加支撑纸板,贴缝在袋布 A 的反面

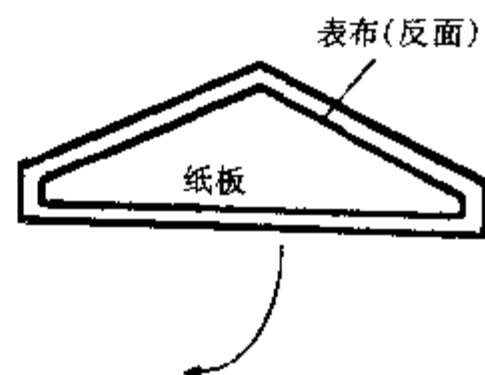
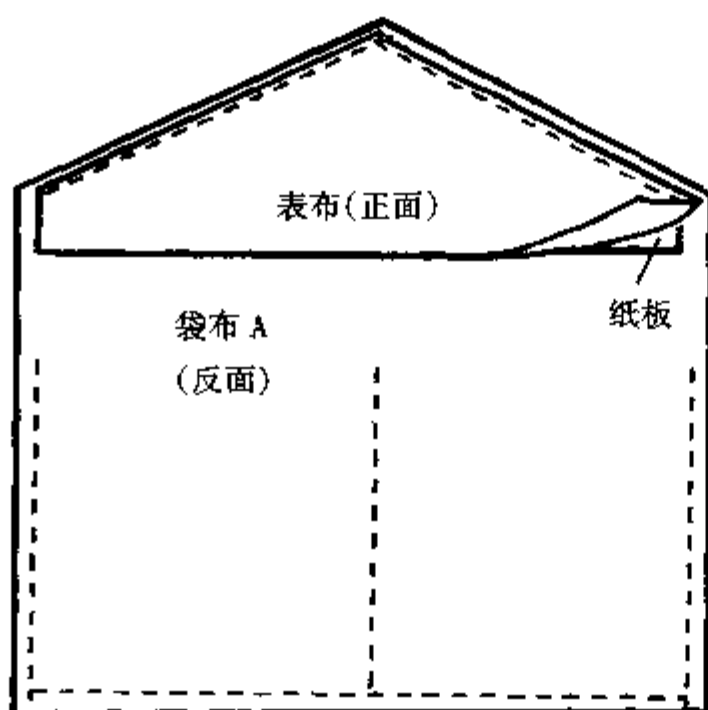

缝装饰物的针法

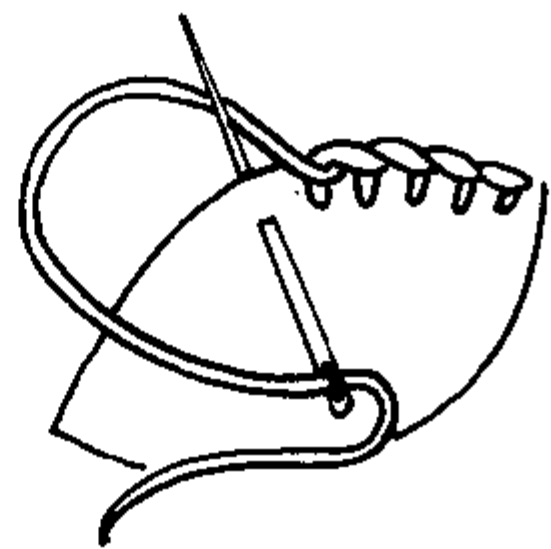
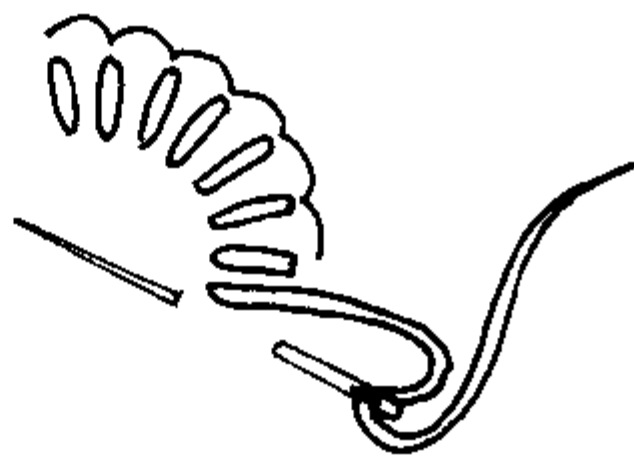
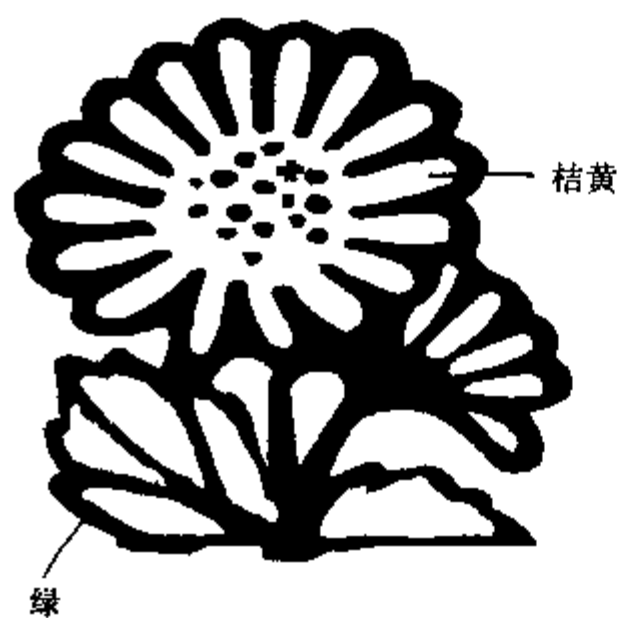

⑧手针线缝房檐,并缉缝挂袷

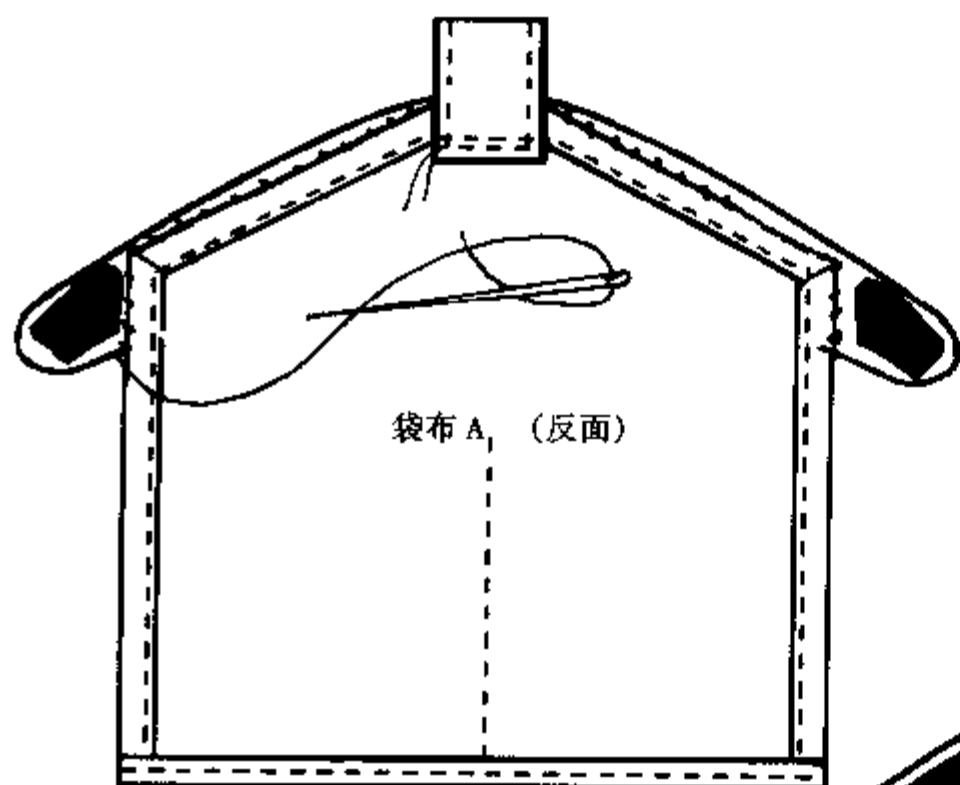

⑦固定房檐装饰

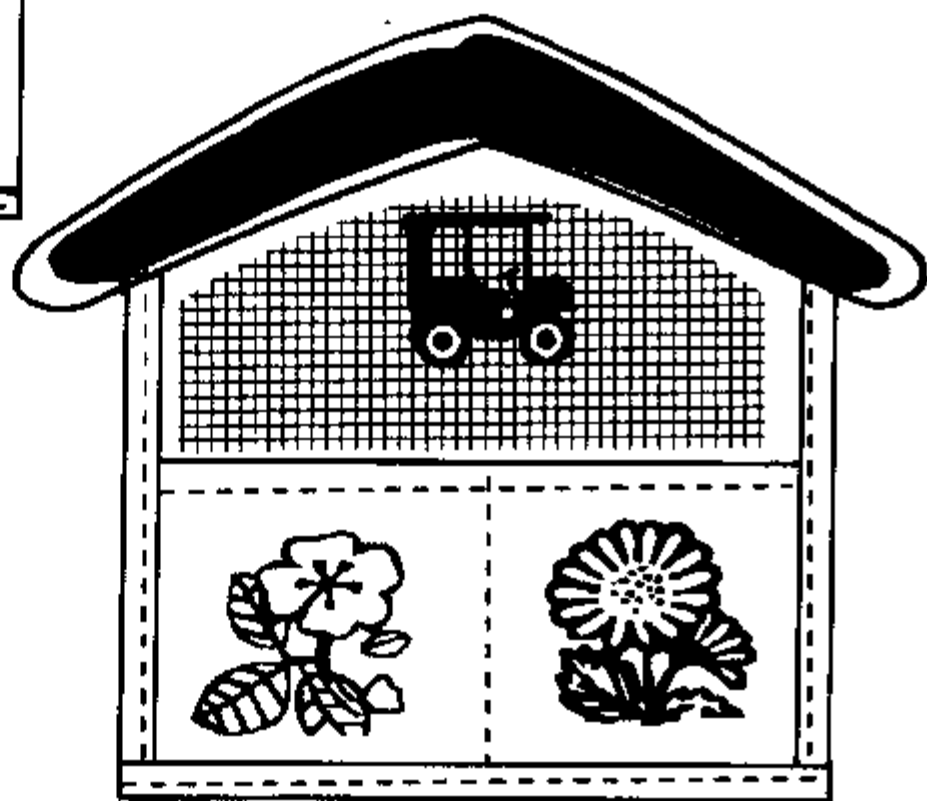

●一帆风顺挂袋

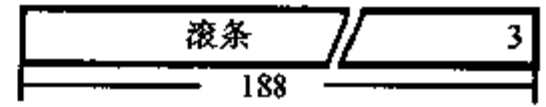
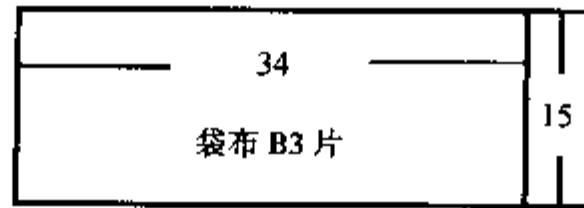
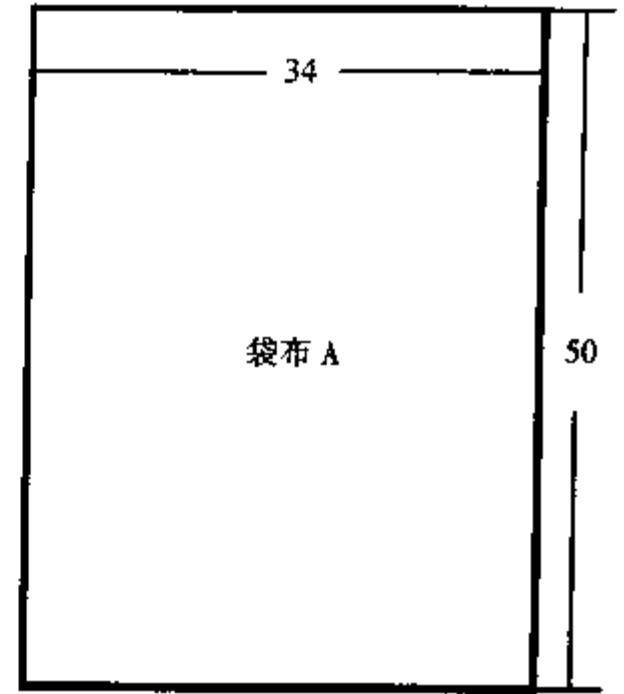
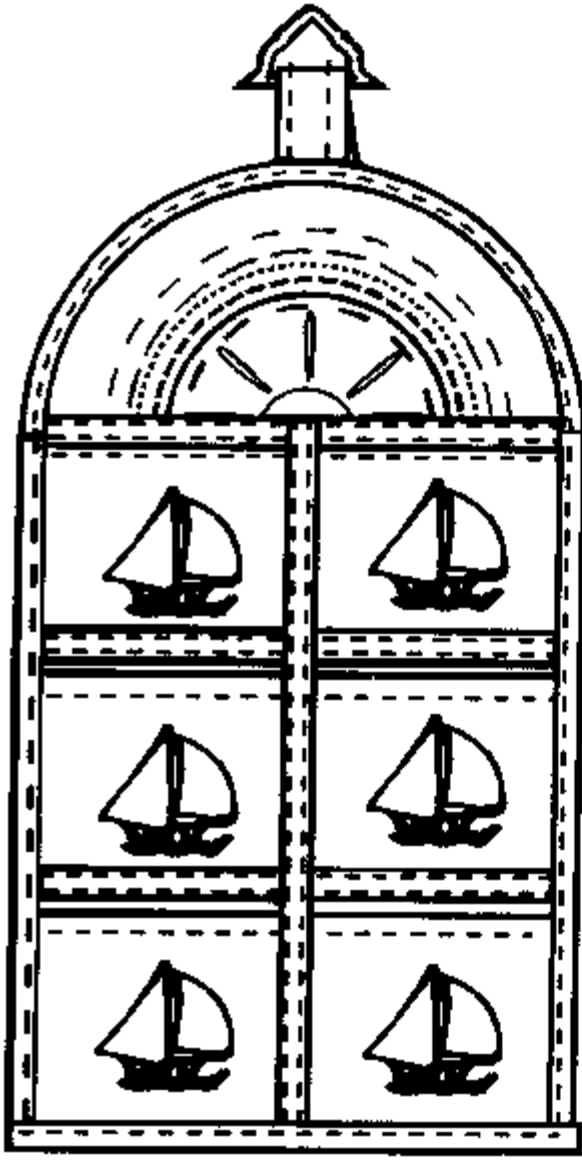

①折边

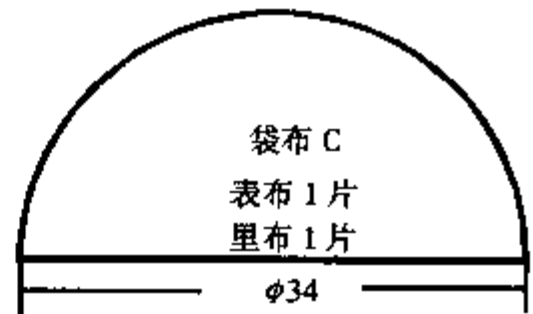

②缉缝袋布 B

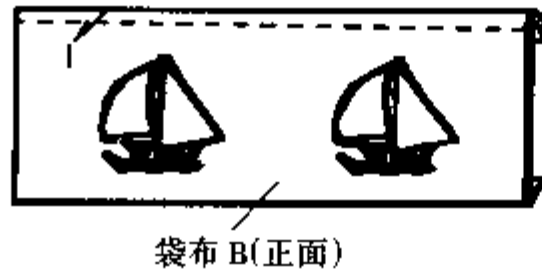

③补绣袋布 C

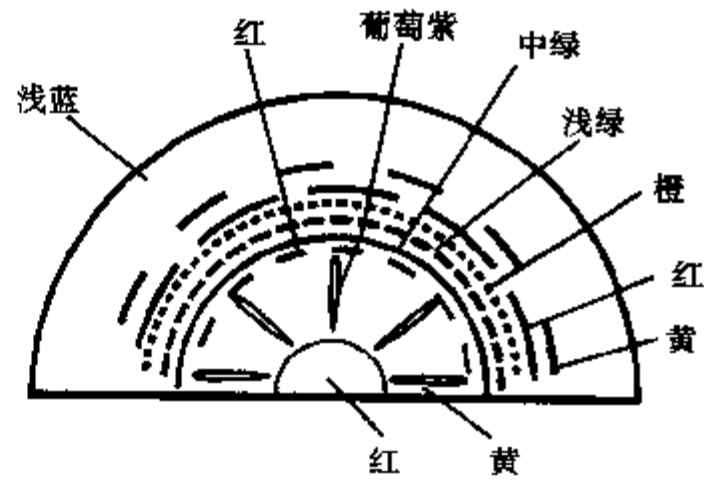

④滚条折边

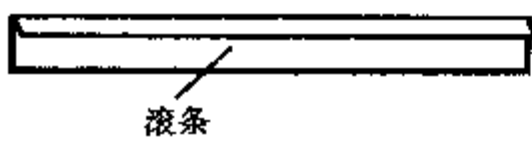

⑤缝合袋布 A 与袋布 C

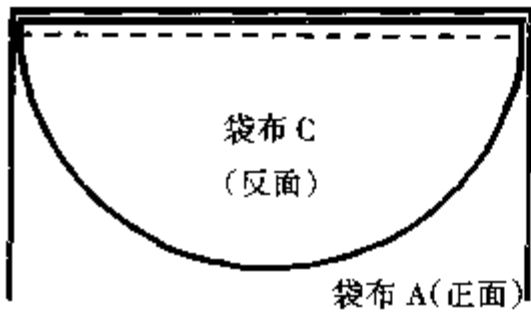

⑥缝合袋布 C 的表、里布, 并加支撑纸板

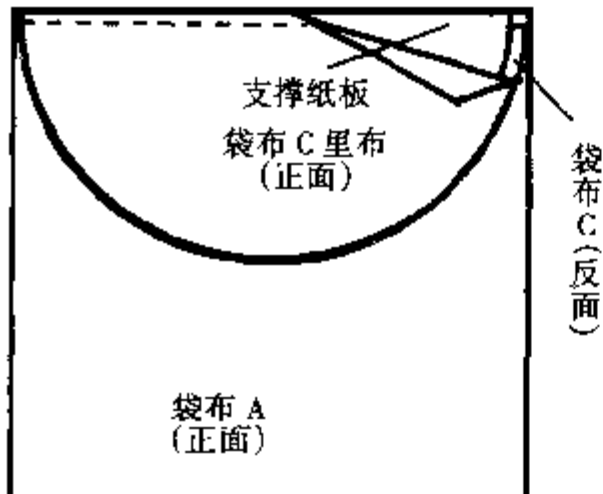

⑦压条缉明线

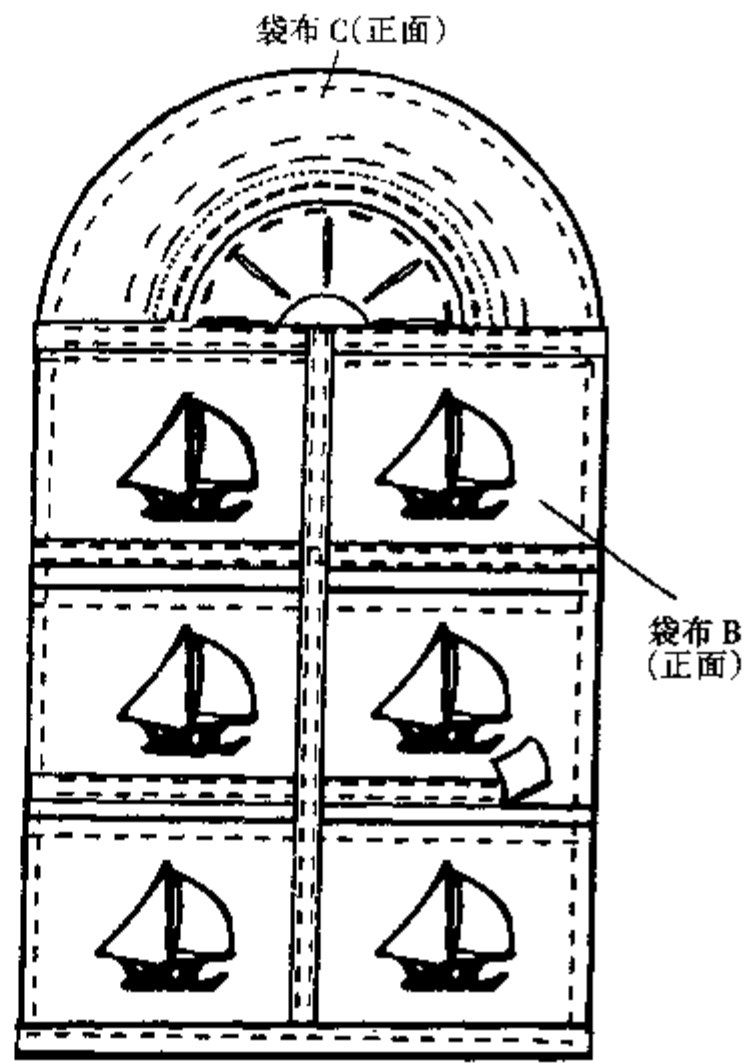

⑧滚边

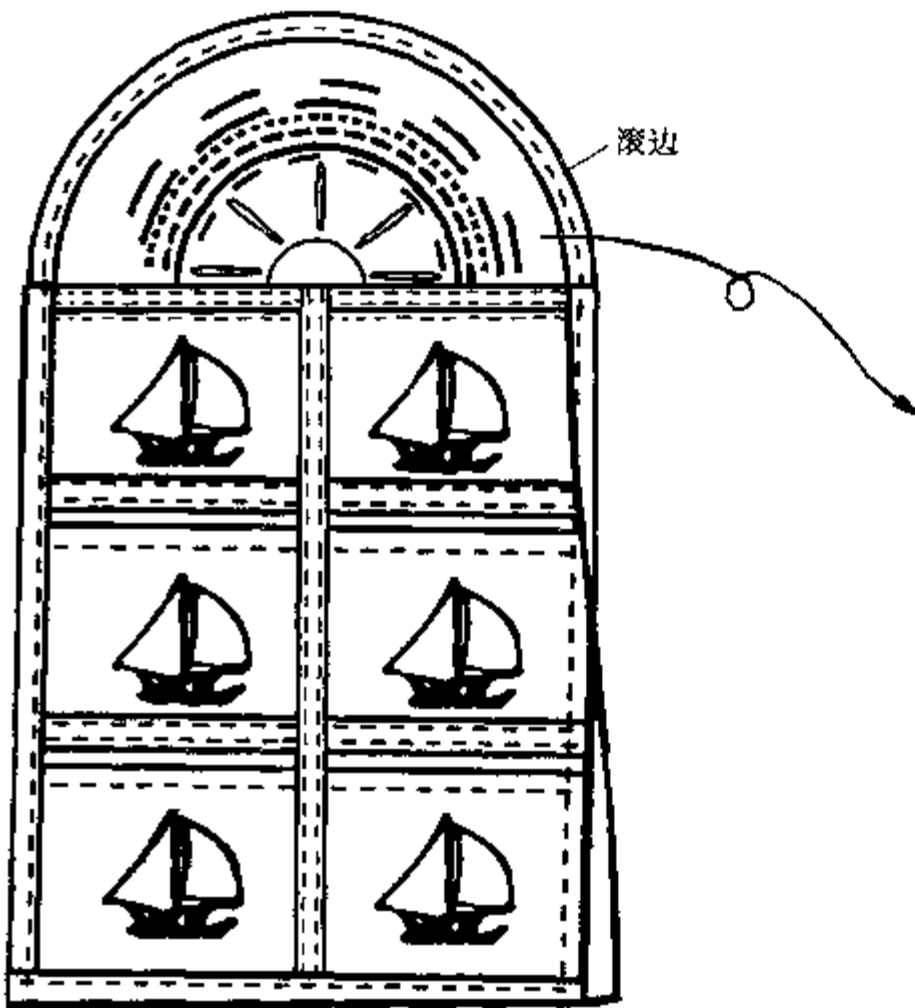

⑨缝合挂环

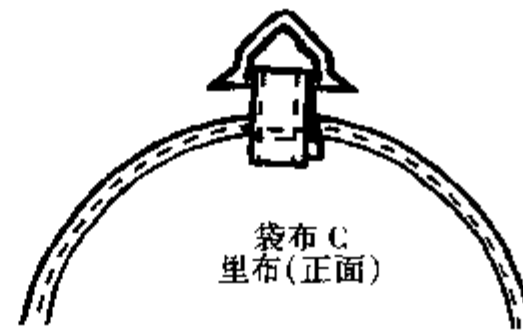

袋布 C 的补绣针法

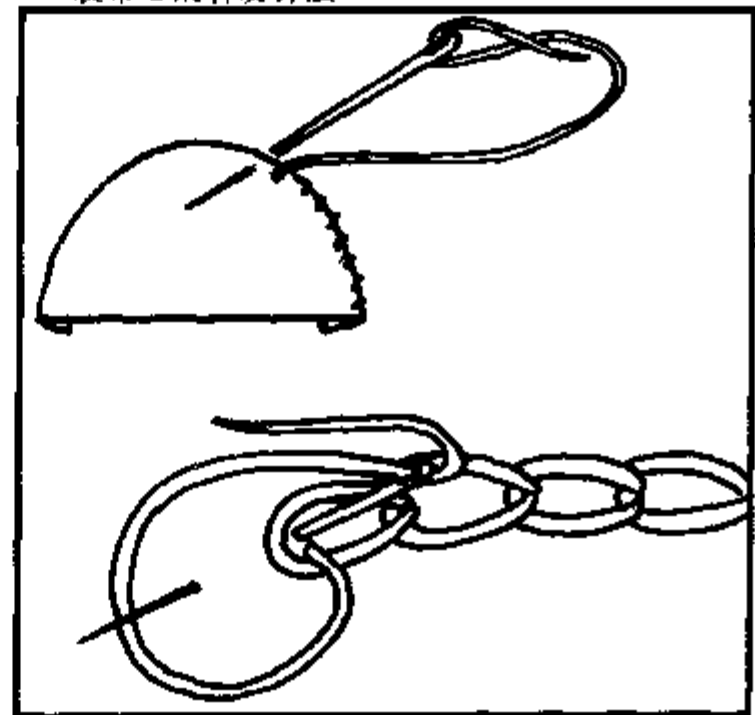

● 彩格四兜挂袋

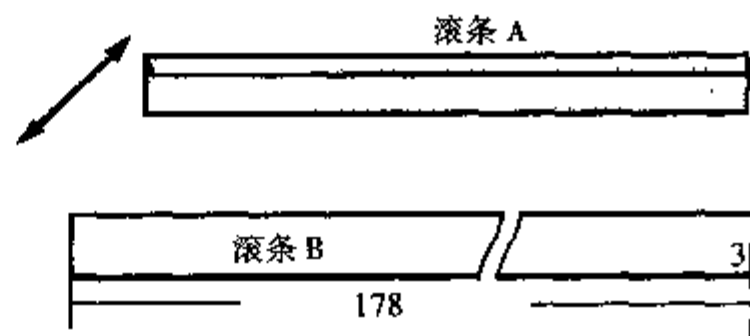
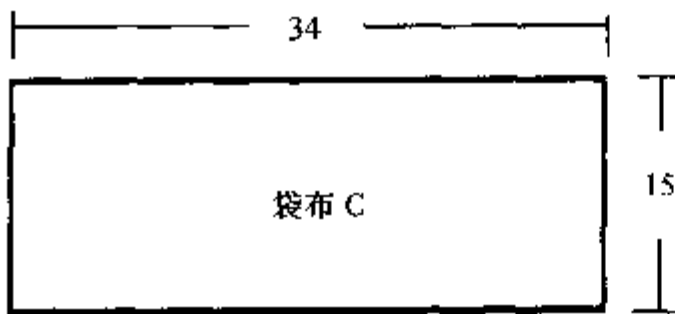
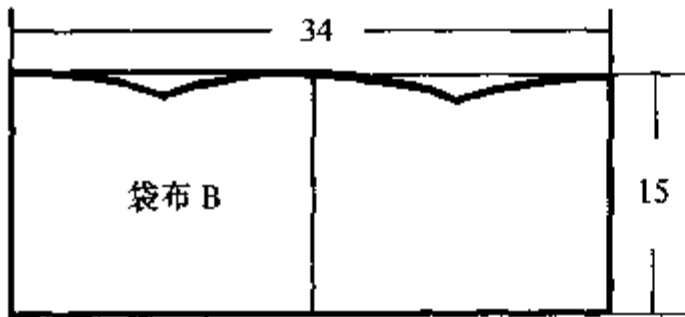
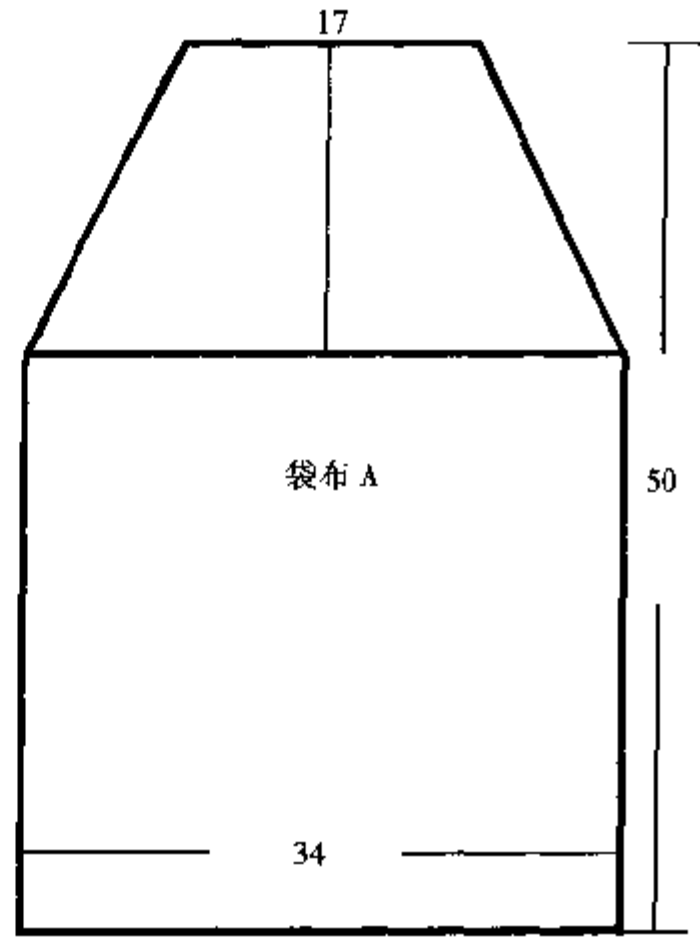
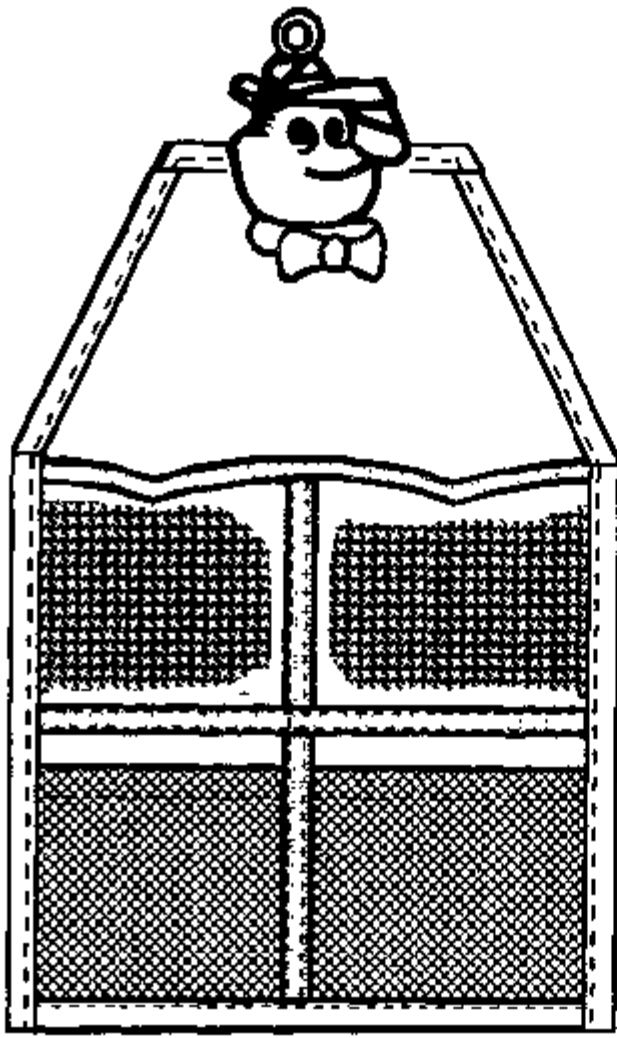

① 滚边

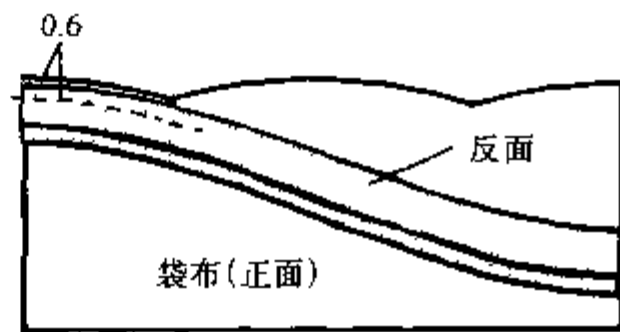

②折边缉缝

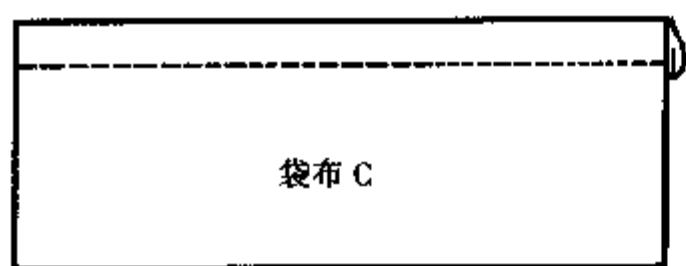

④挂袋滚边

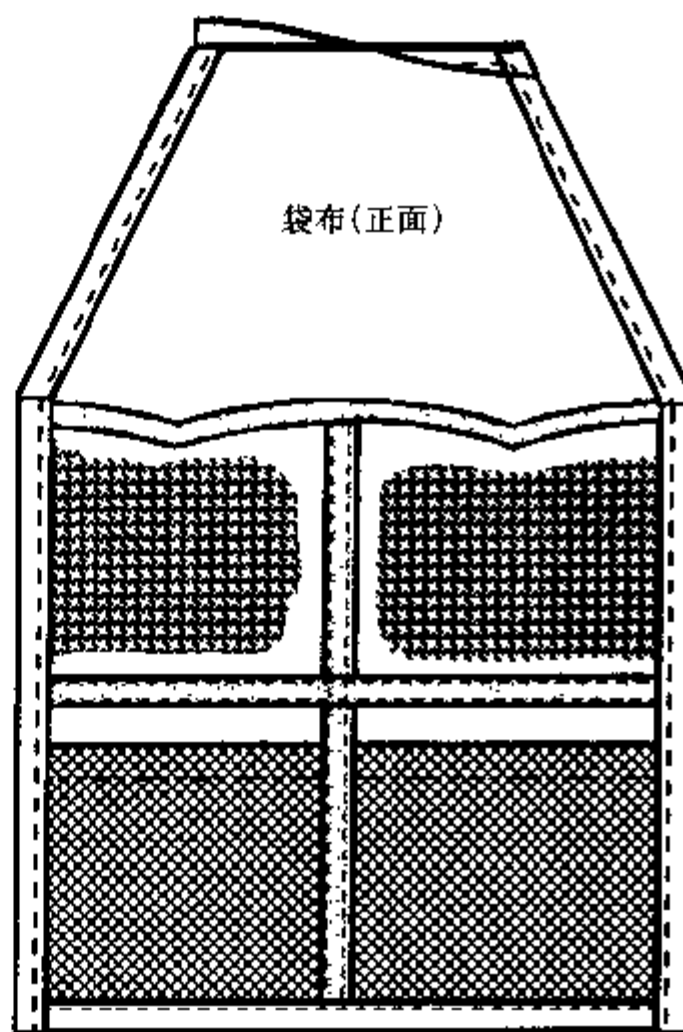

③缝合袋布 A、袋布 B、袋布 C

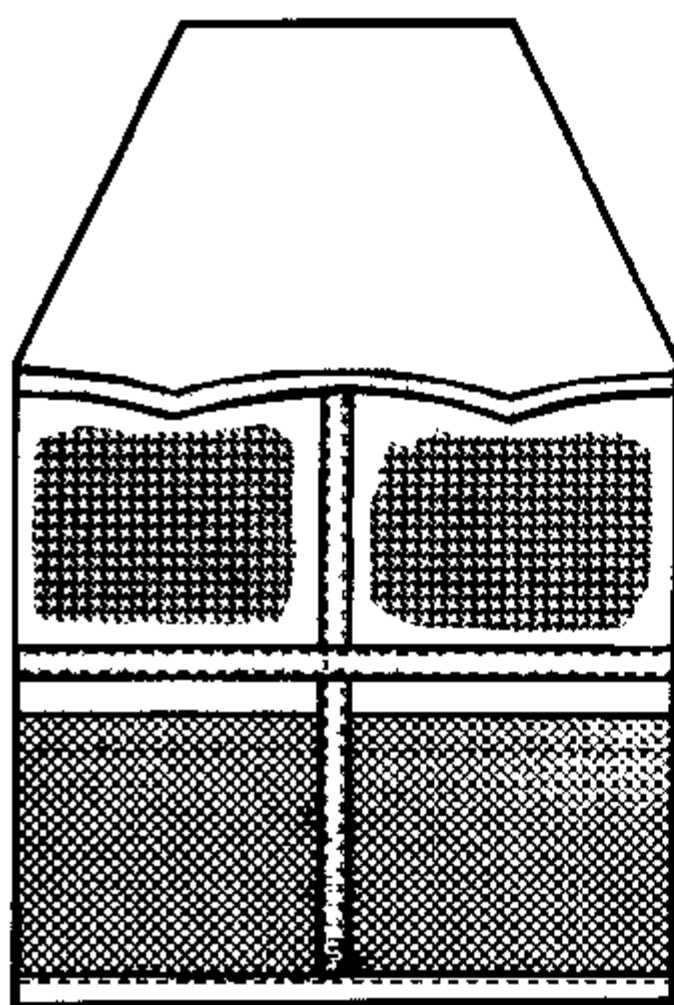

缝制装饰物

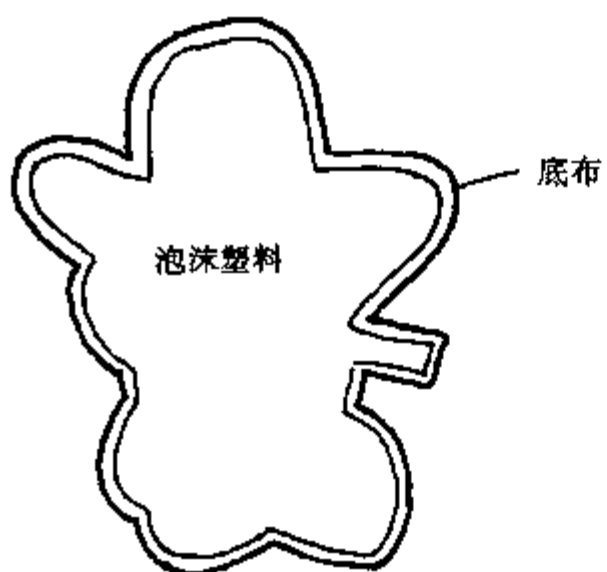
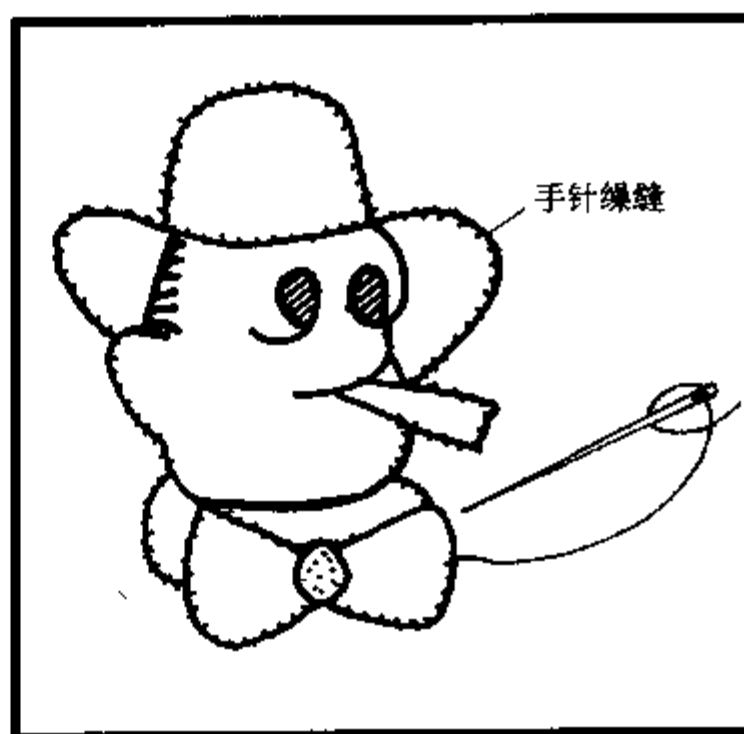

● 多用图案挂袋

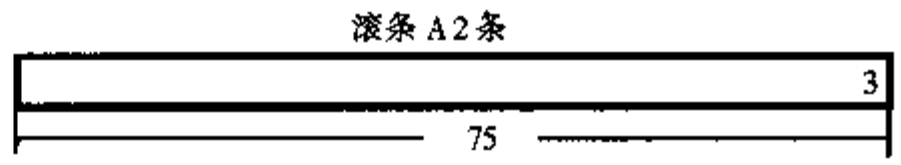
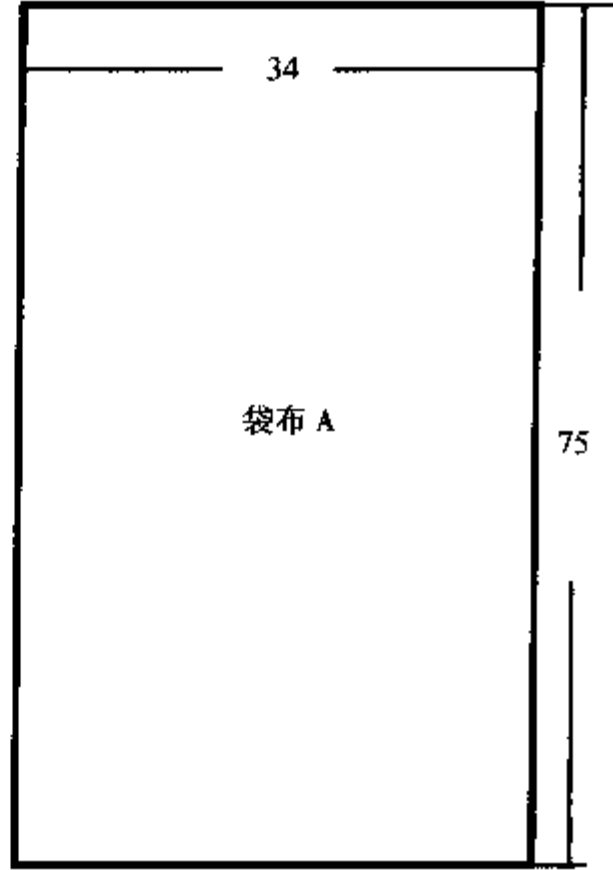
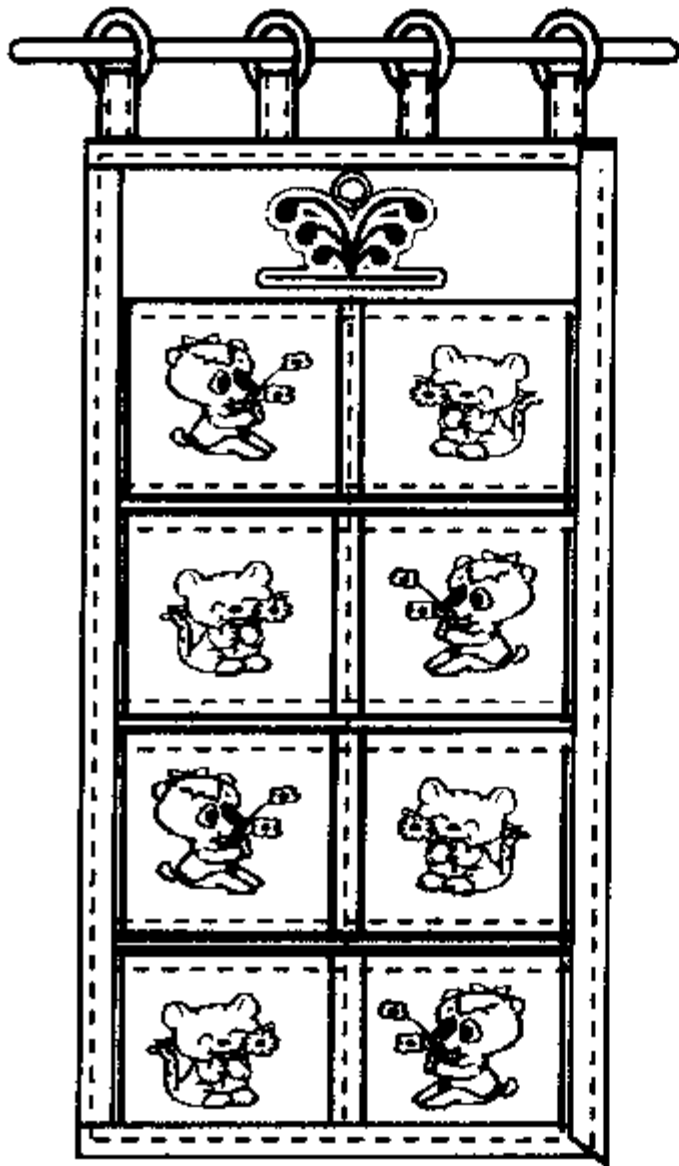

① 折边

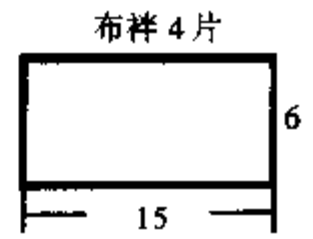
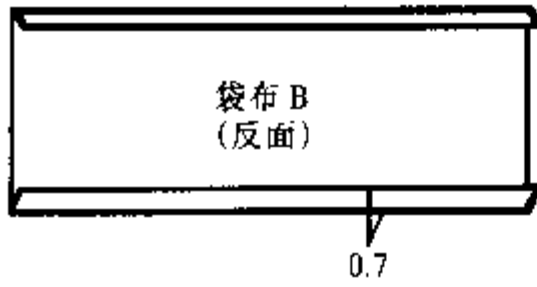

② 缉缝袋布 B



③ 熨烫袋墙裱

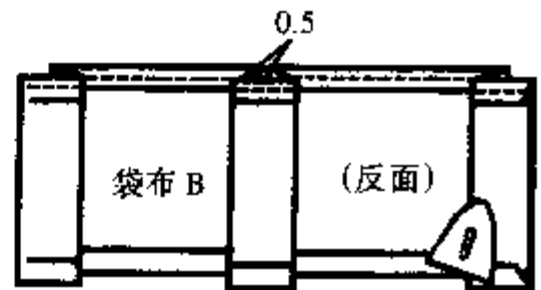

④缝合袋布 A 与袋布 B

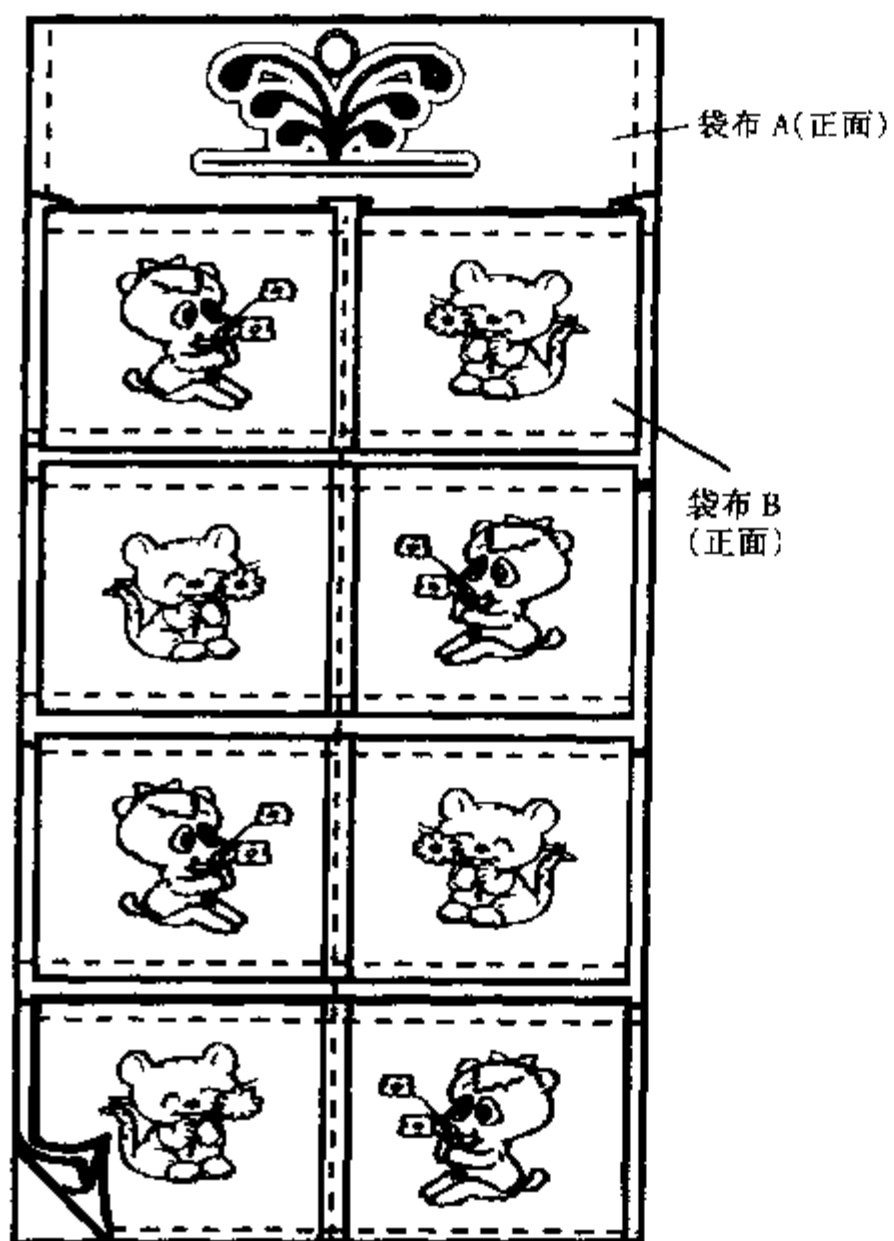

⑤折边

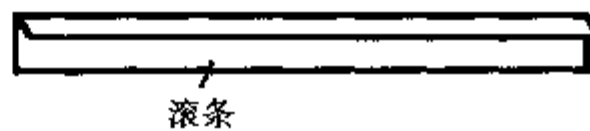

⑥滚边

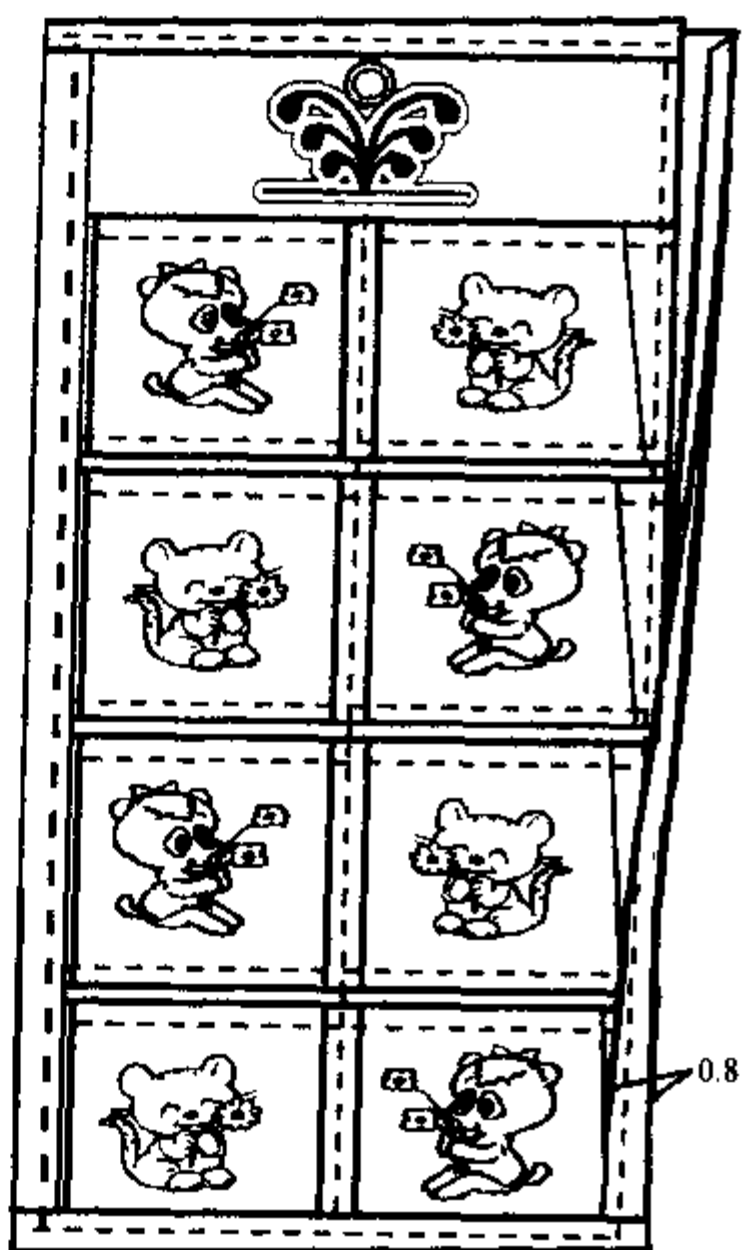

装饰图案的针法

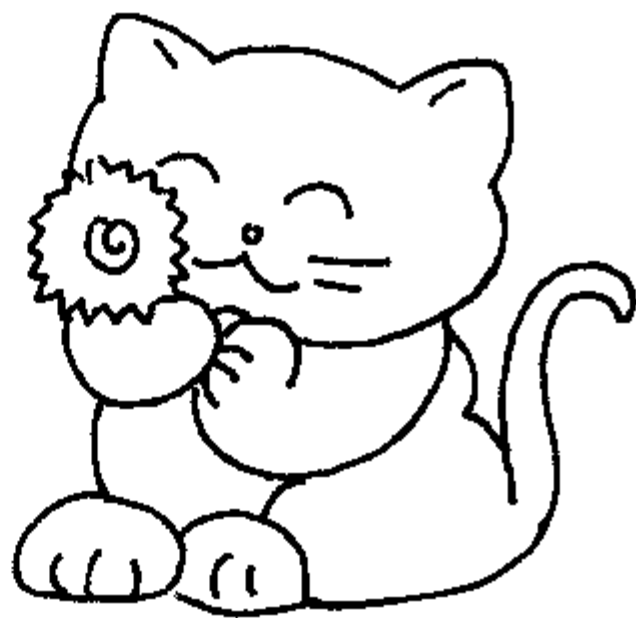
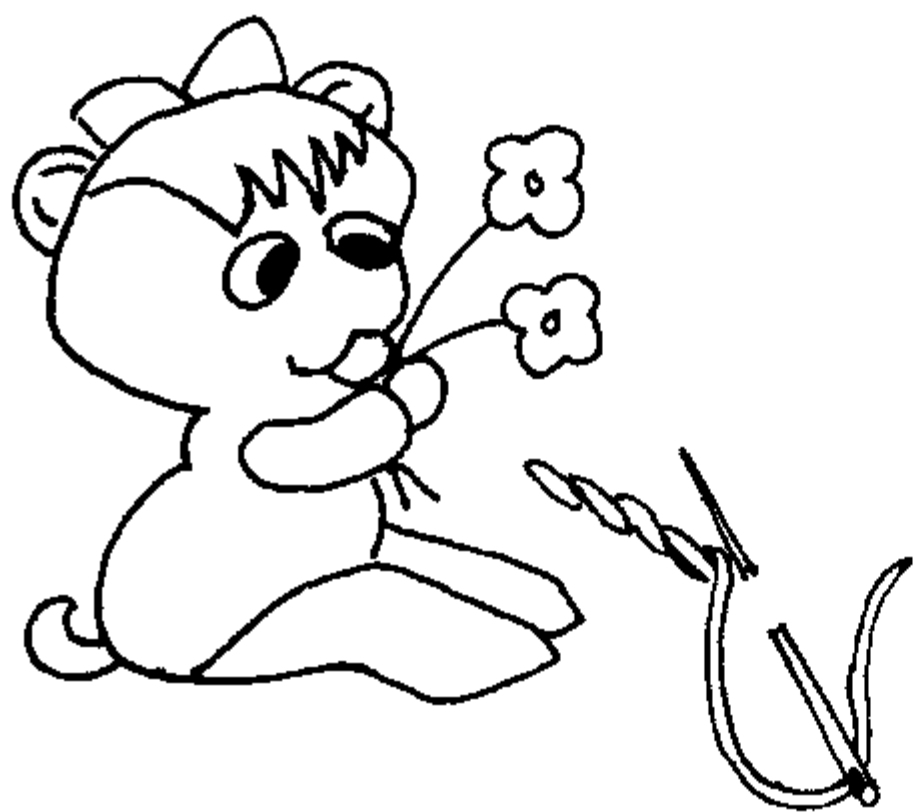

● 联组多用挂袋

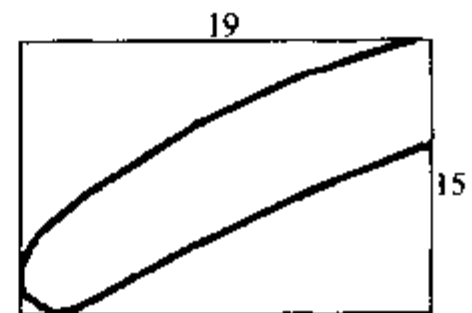
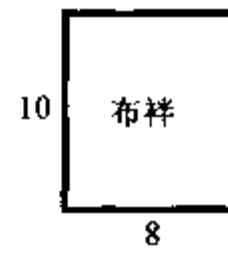
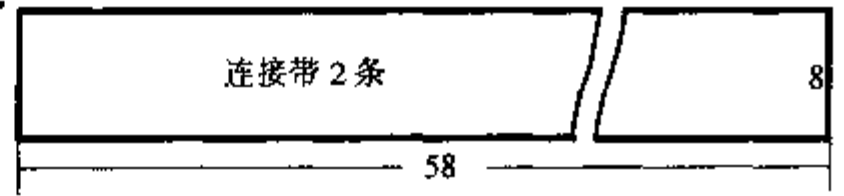
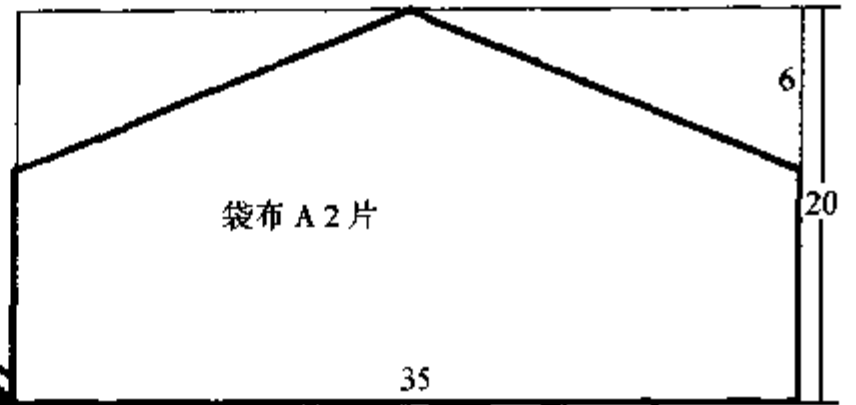
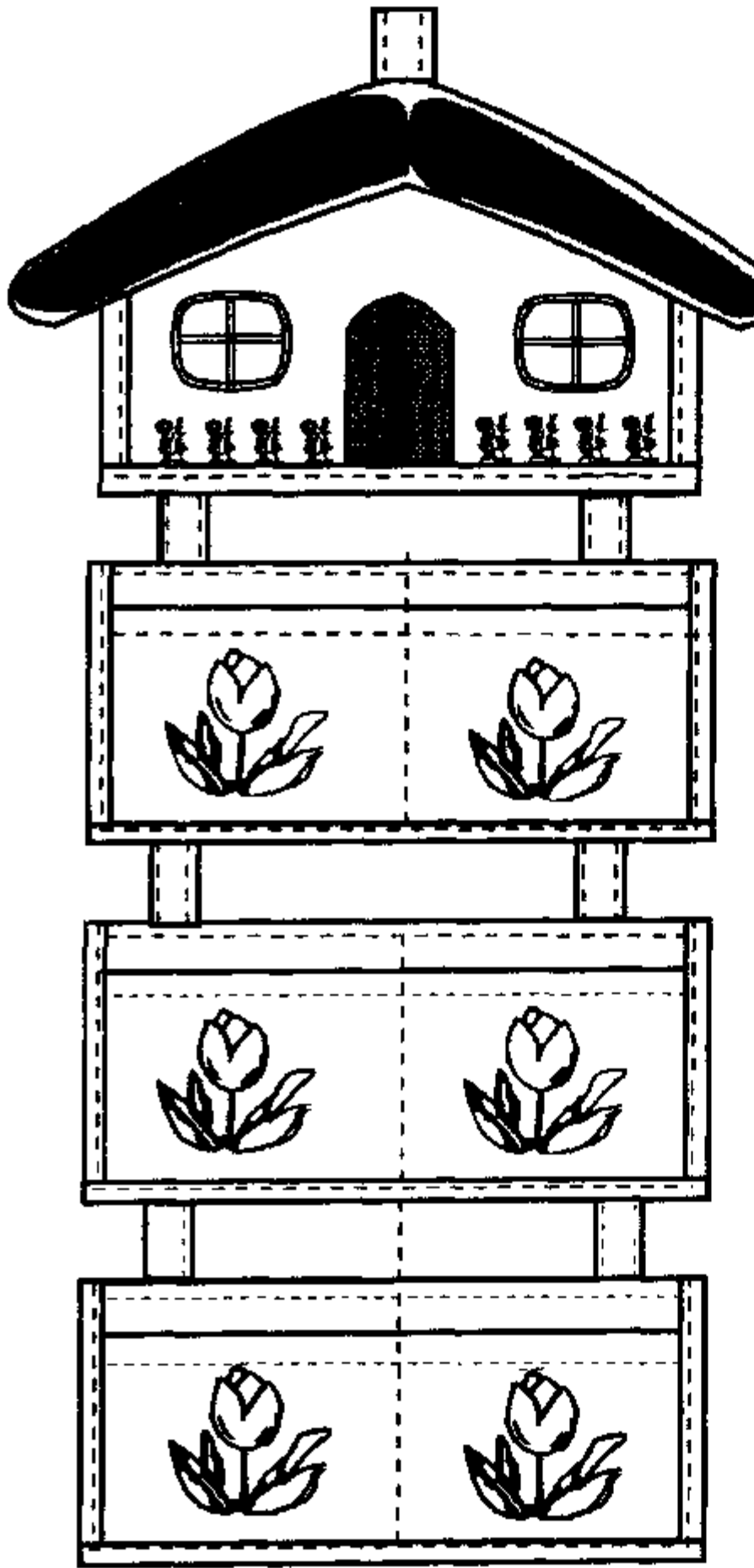

①缝制装饰房檐

a. 缝合两片装饰布并加填充料

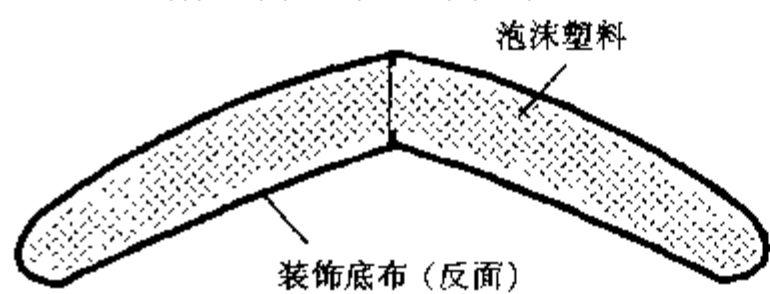

b. 装饰布正面相对缝合

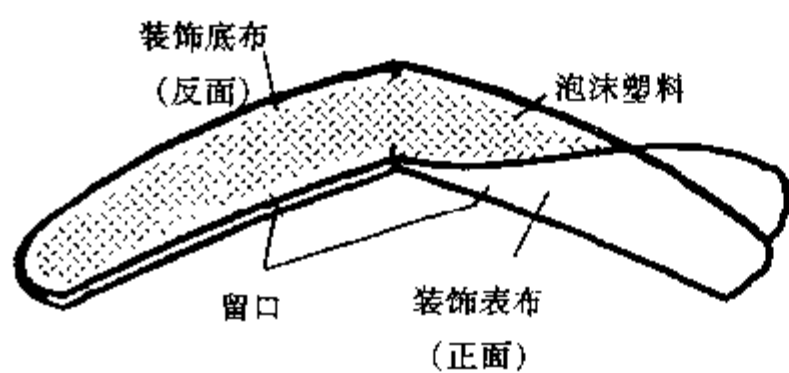

c. 翻至正面, 手针线缝

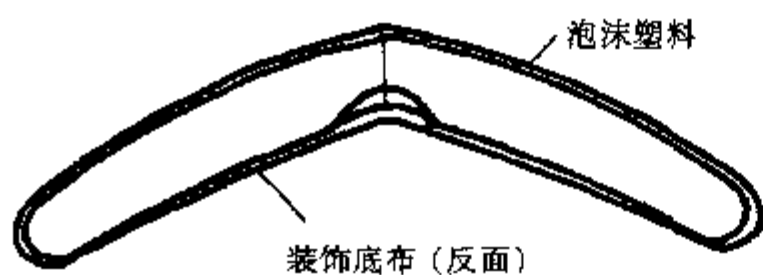

剪布贴缝

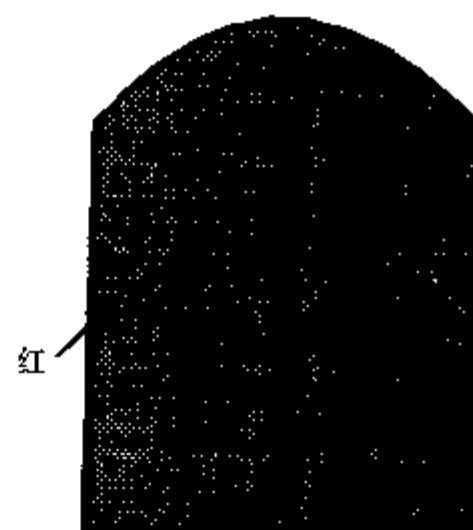

大门

窗户

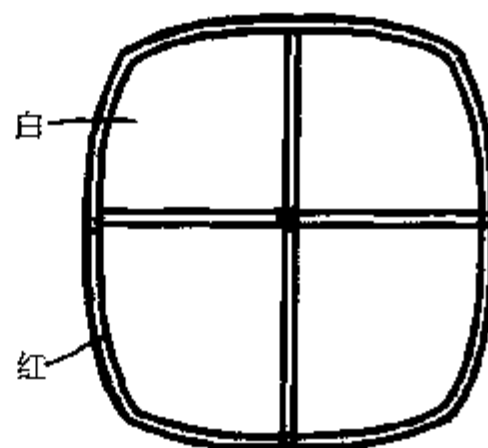

②绣缝袋布 A、袋布 B 上的装饰图案



花

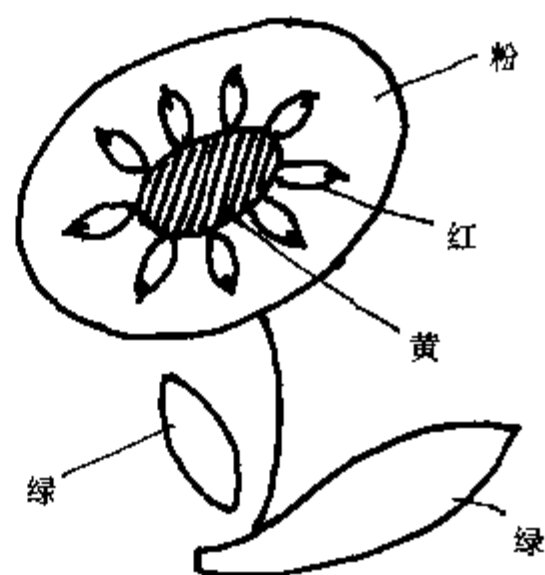

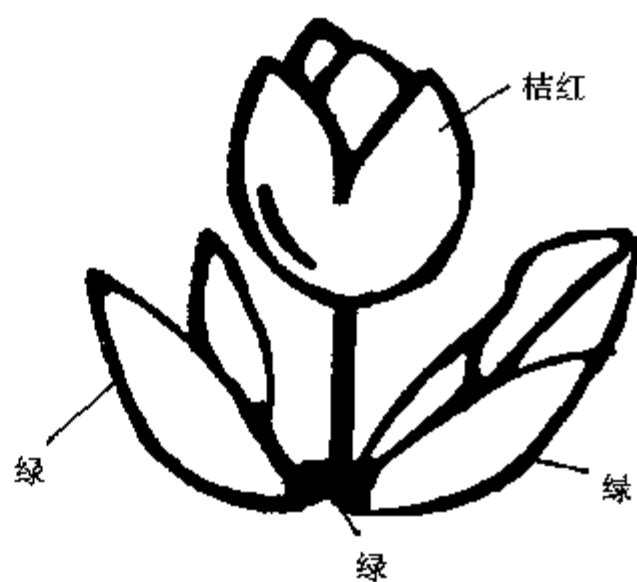

③沿袋口边

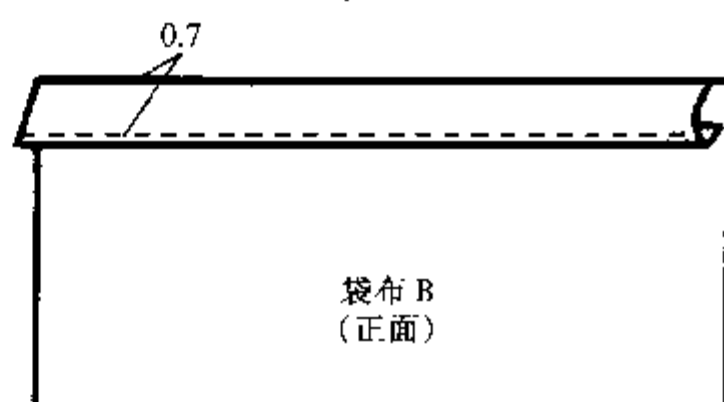
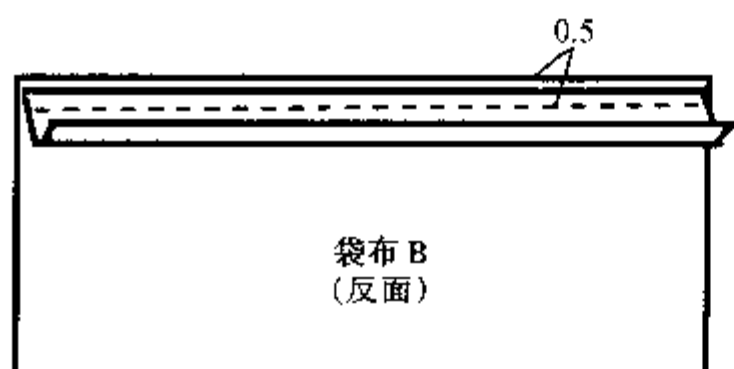

袋布 B(正面)

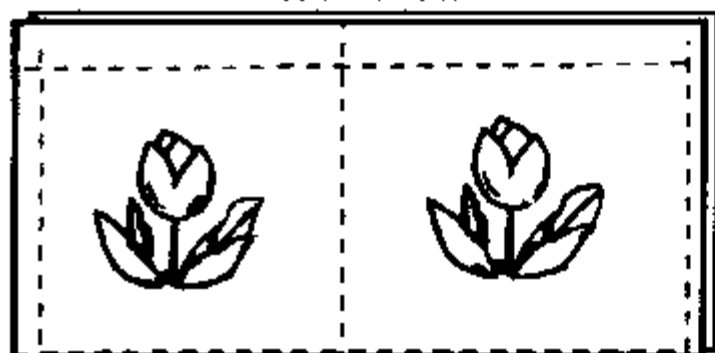

④在袋布 B 的底布上加填充料

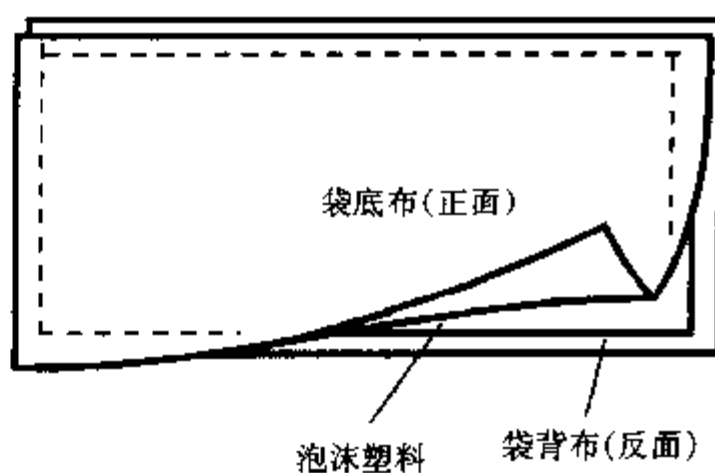

⑤在袋布 A 的里面加支撑纸板

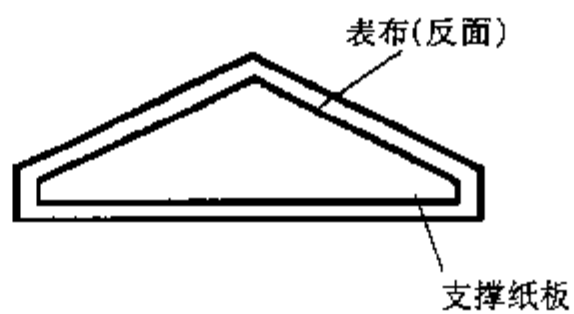
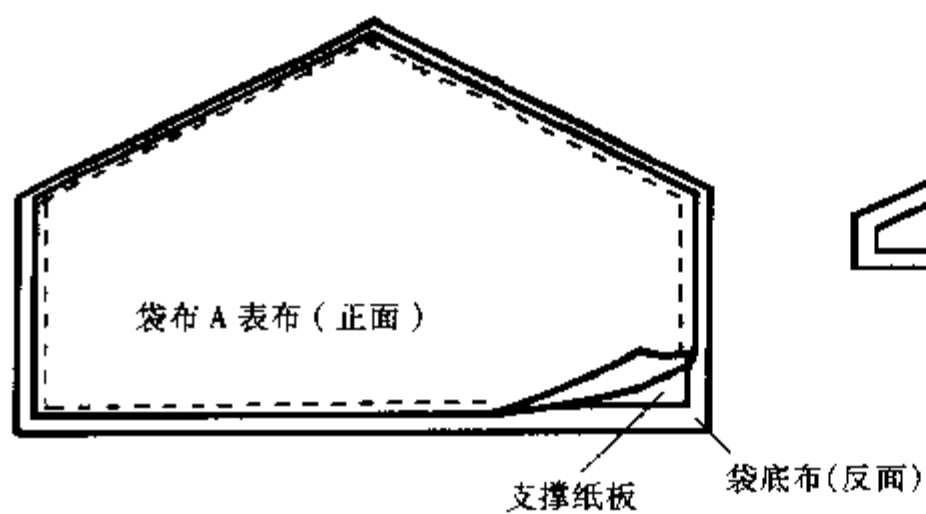

⑥滚边

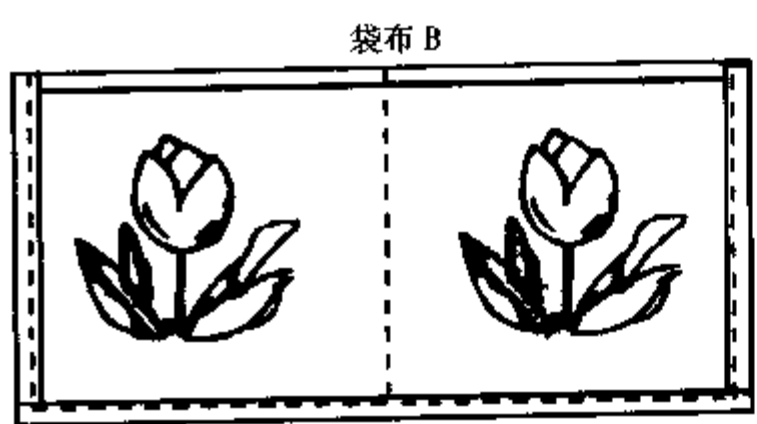
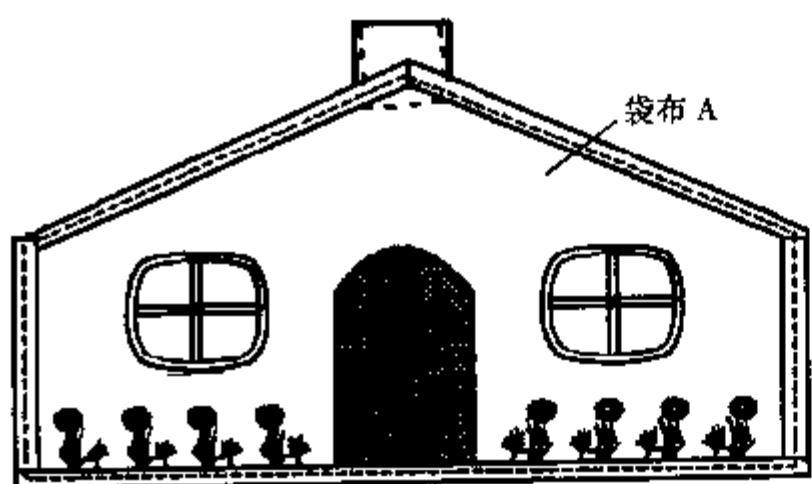

⑦固定房檐装饰

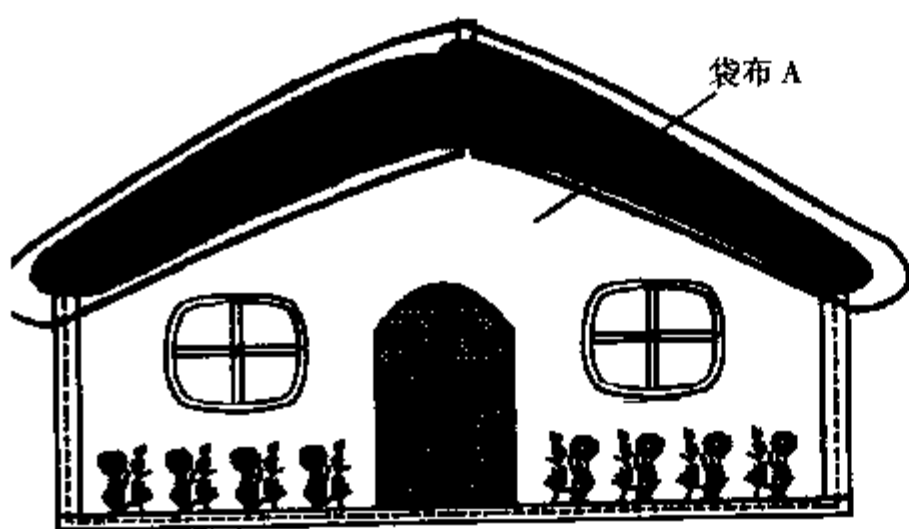

⑧缝合吊挂布帘及连接带

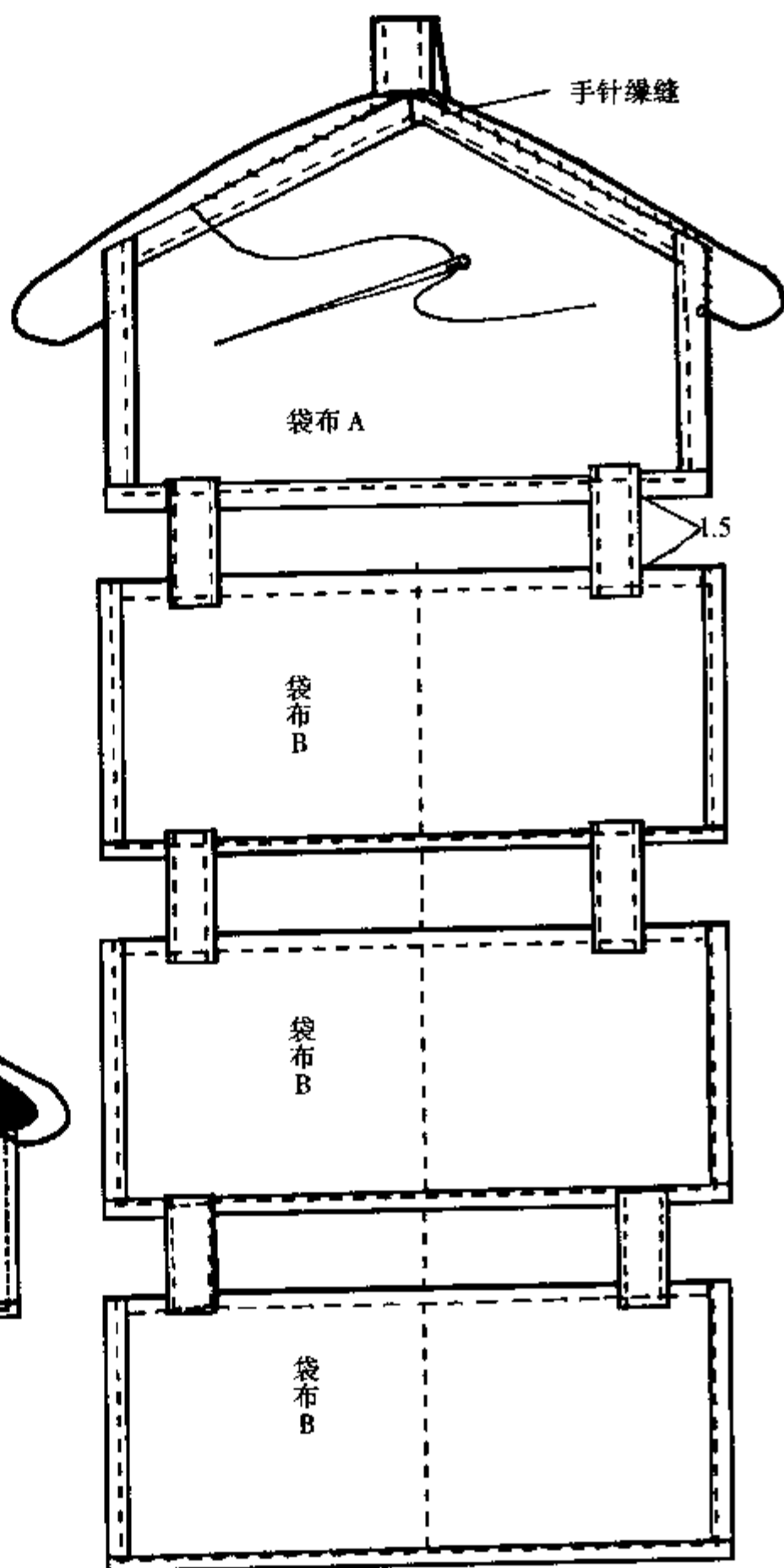

实用工艺物品的制作

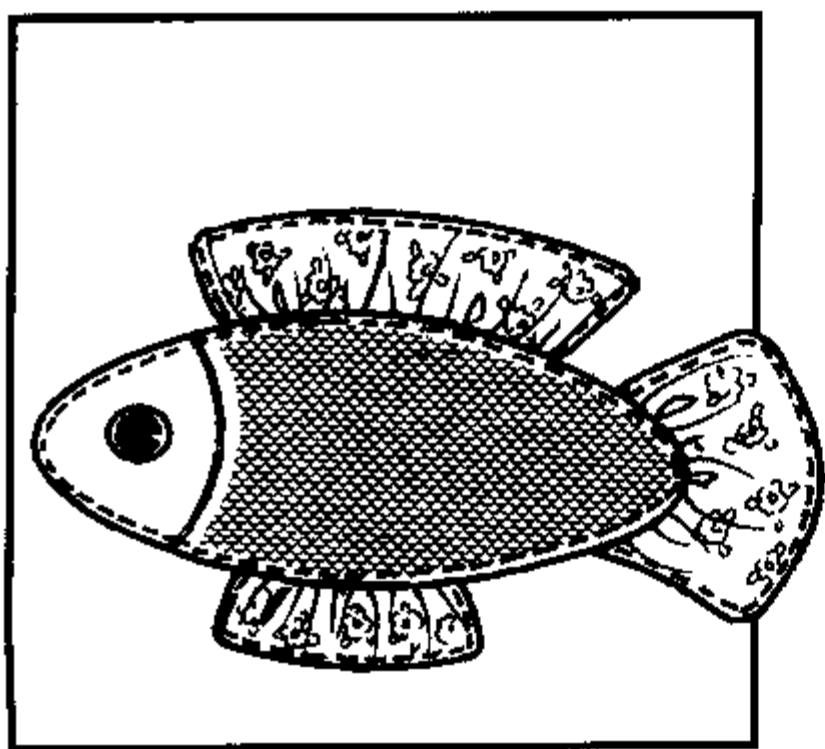

● 鱼形抱枕

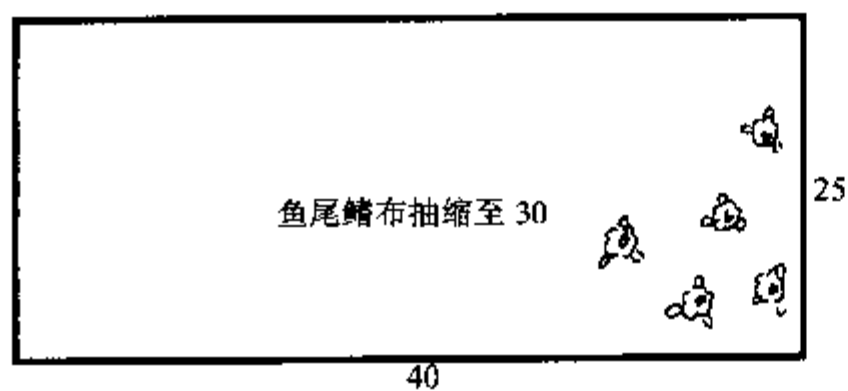
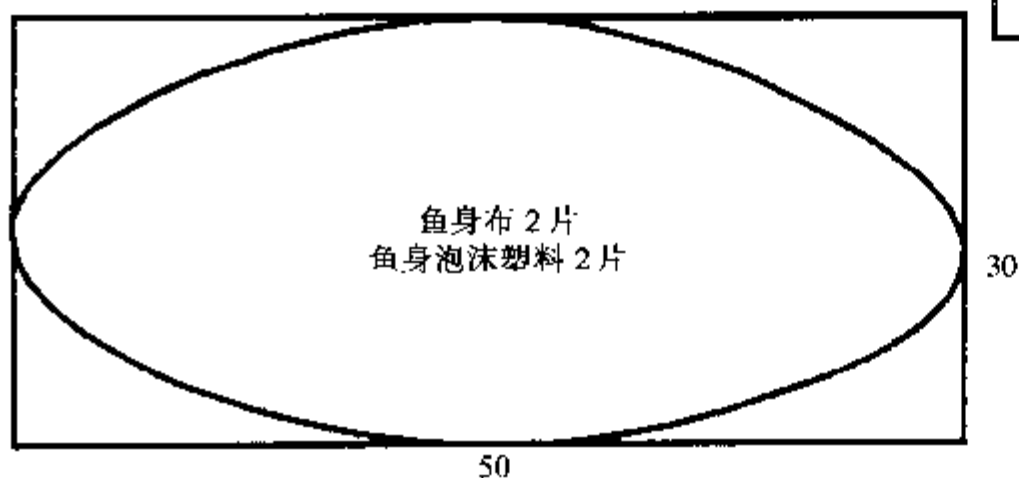
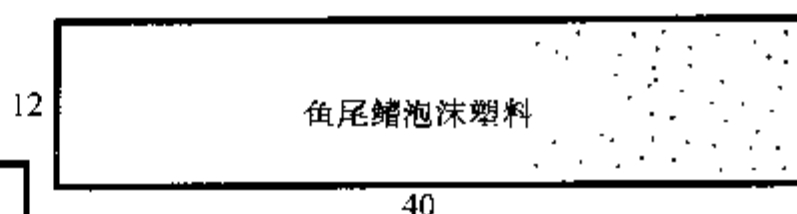
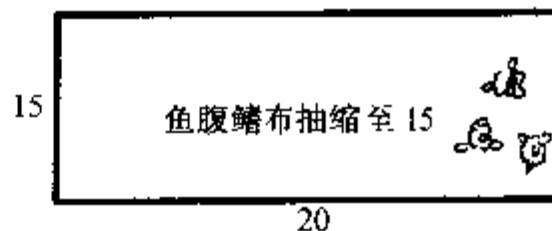
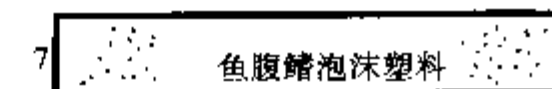
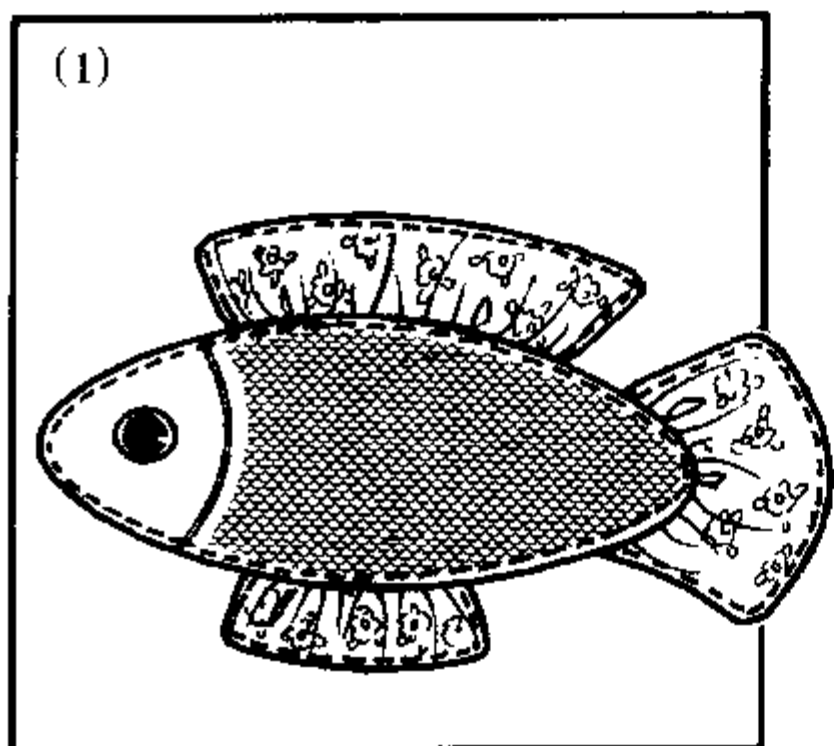

① 缝合鱼背鳍

a. 缝合两侧

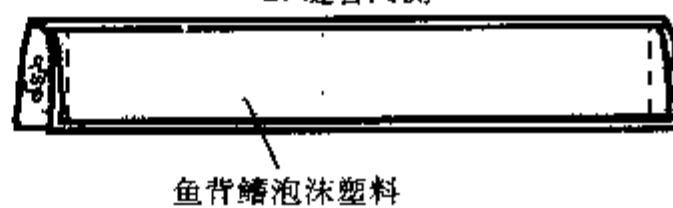

b. 抽褶



c. 抽褶效果

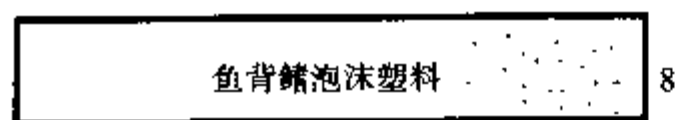
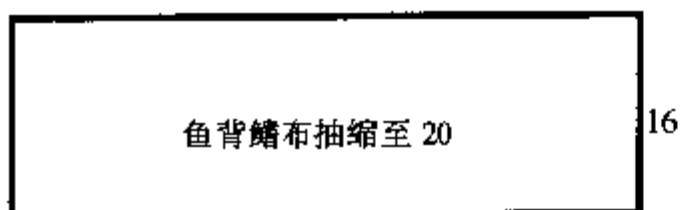

②缝合鱼腹鳍

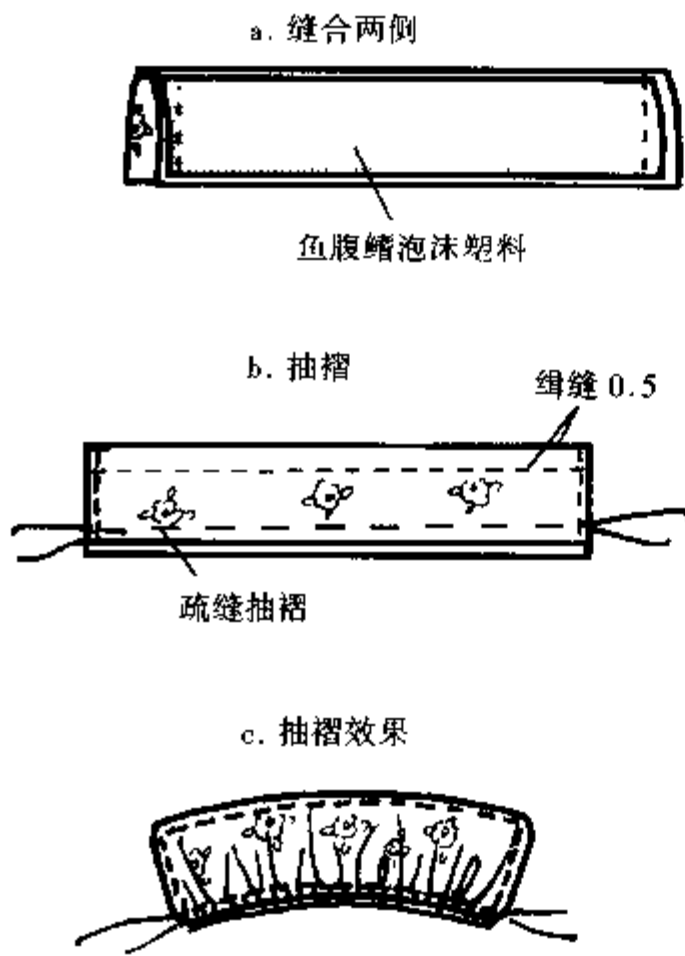

③缝合鱼尾鳍

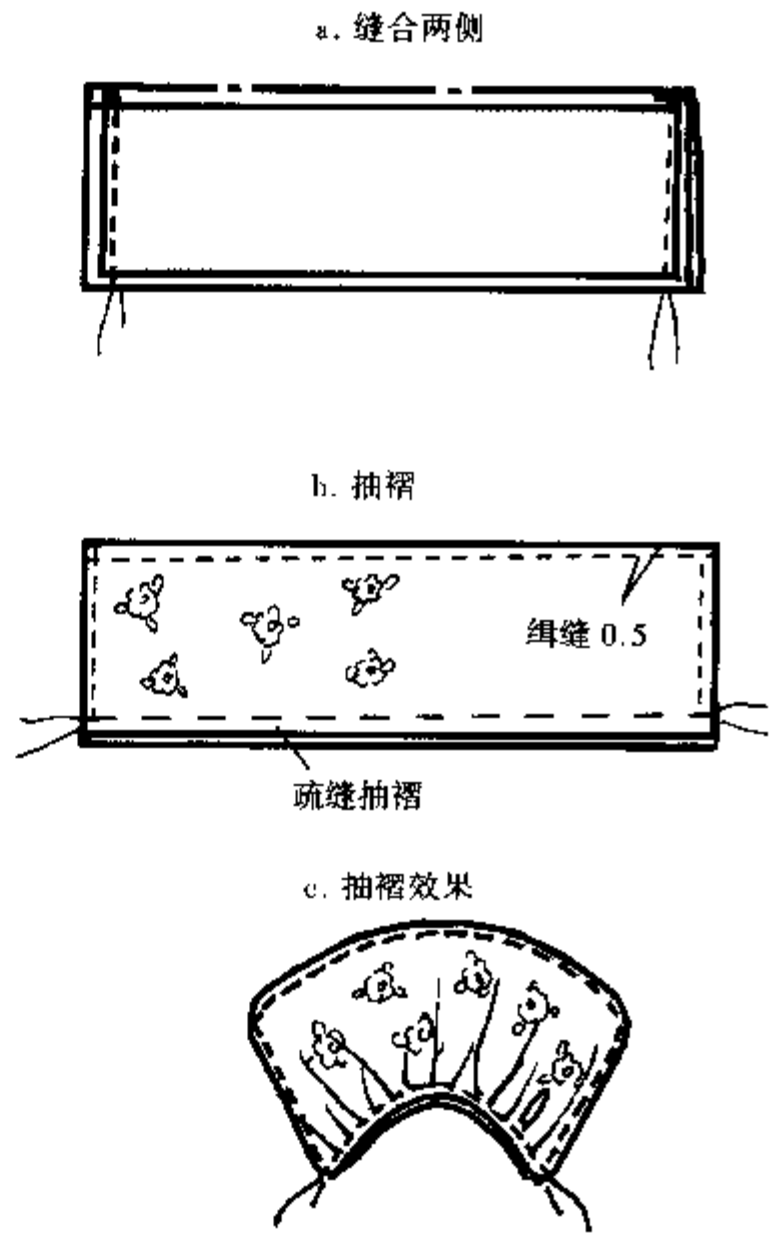

④加泡沫塑料并缉缝鱼身布

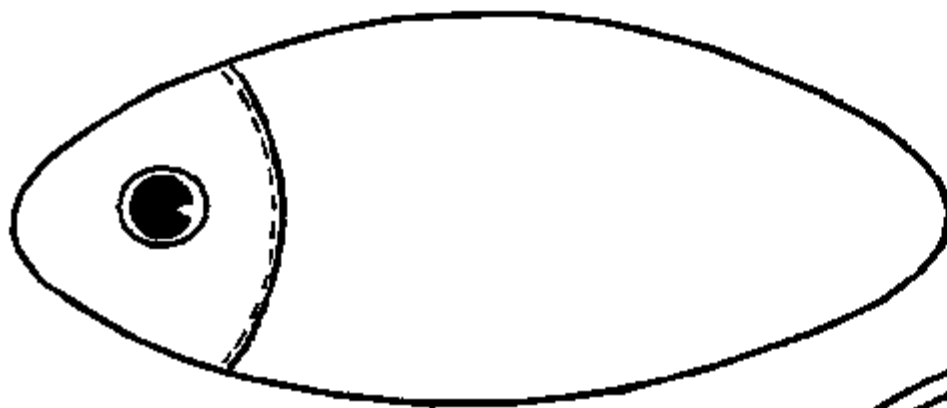

⑤折边扣烫

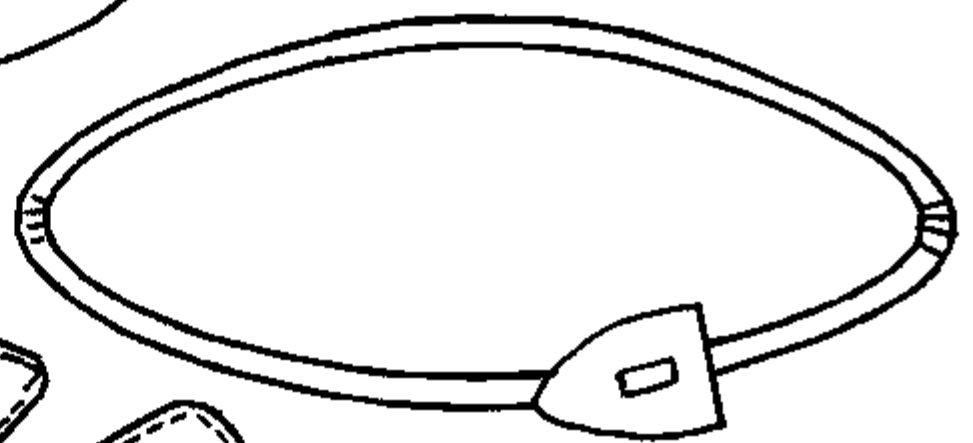

⑥将鱼鳍、鱼尾固定在鱼身上

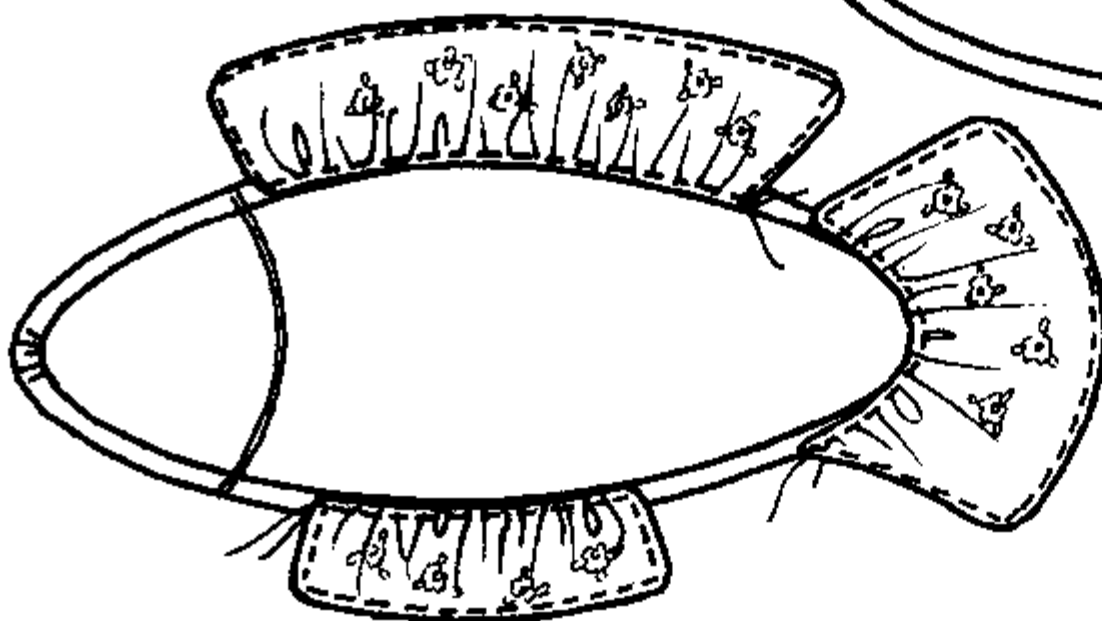

⑦夹缝鱼鳍,并填充膨松棉

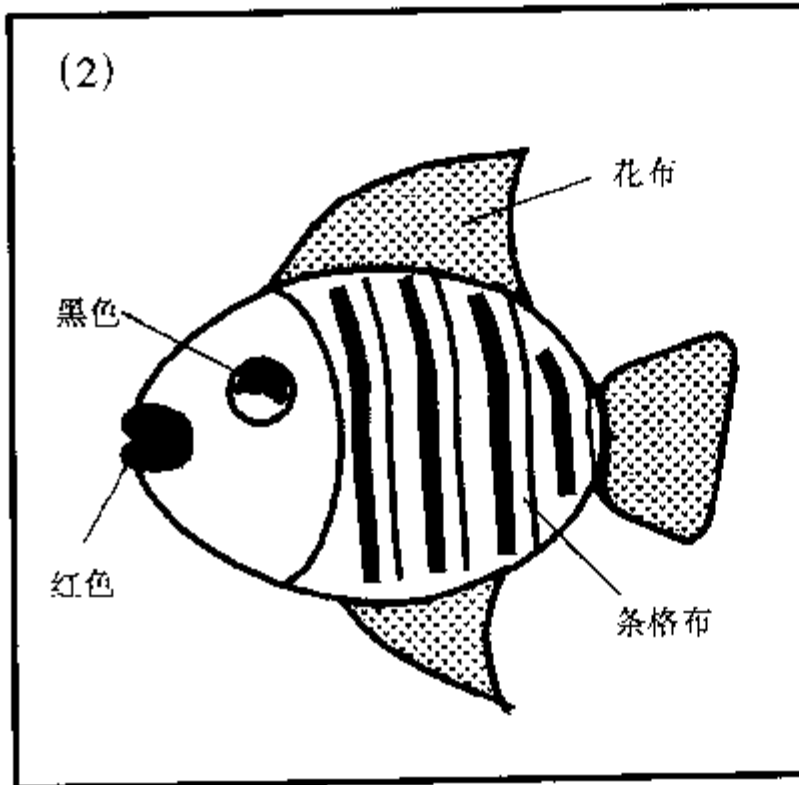
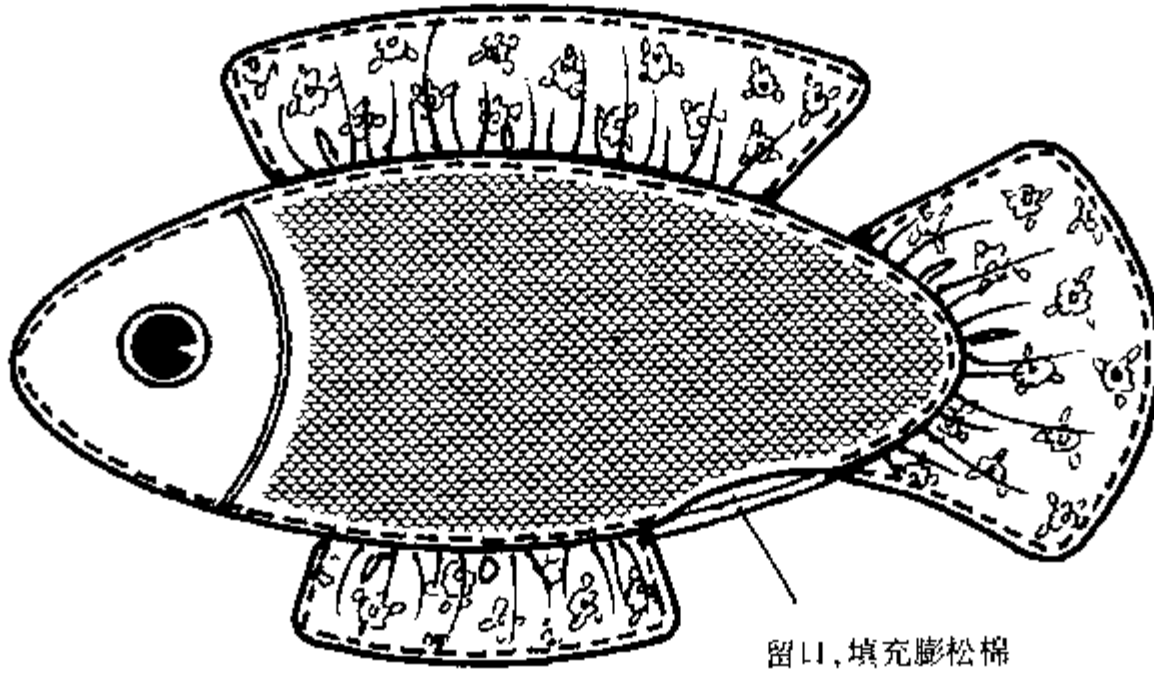

缝制方法同前

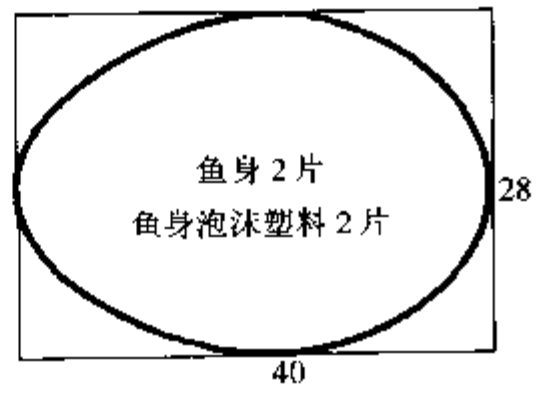

鱼背鳍 2 片
鱼背鳍泡沫塑料

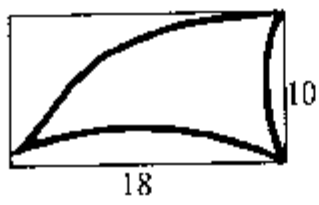

鱼腹鳍 2 片
鱼腹鳍泡沫塑料

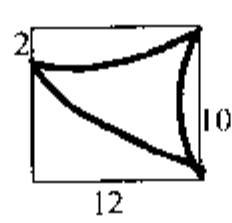

鱼尾鳍抽缩至 20
鱼尾鳍泡沫塑料

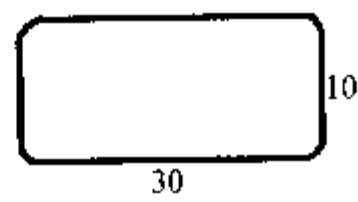

(1) 宝宝装饰



● 卫生纸装饰套

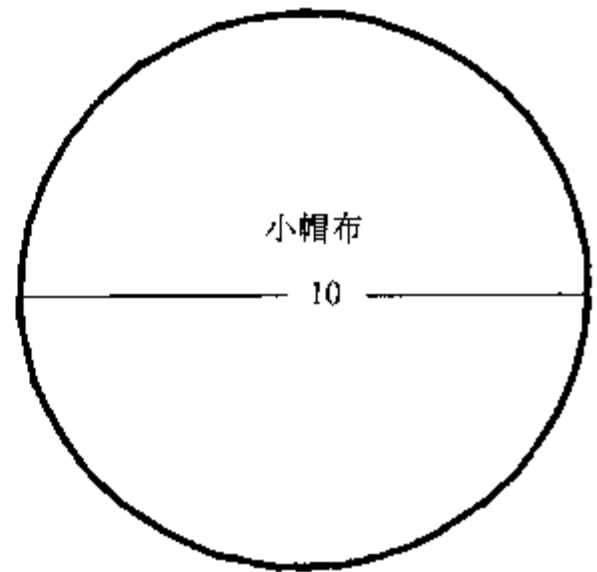
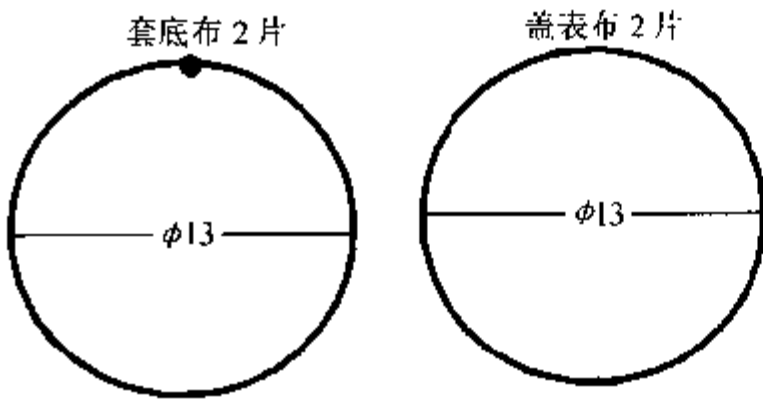
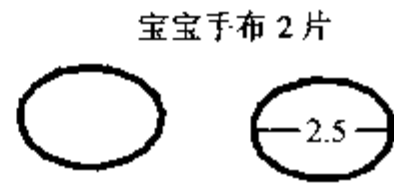
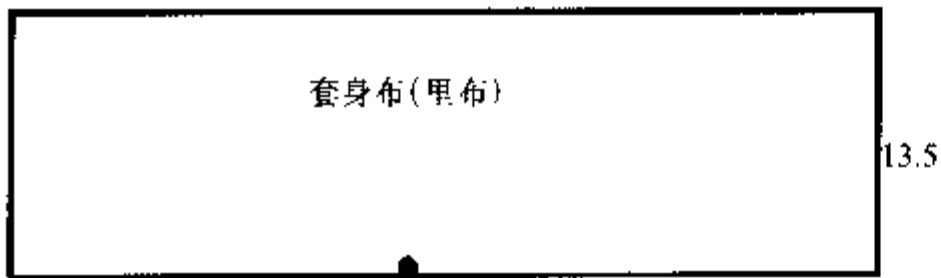
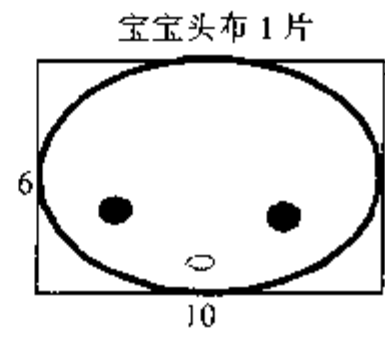
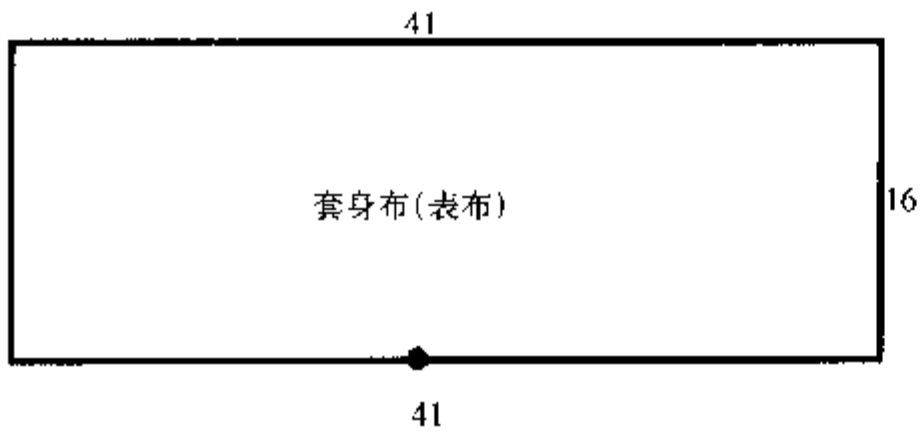
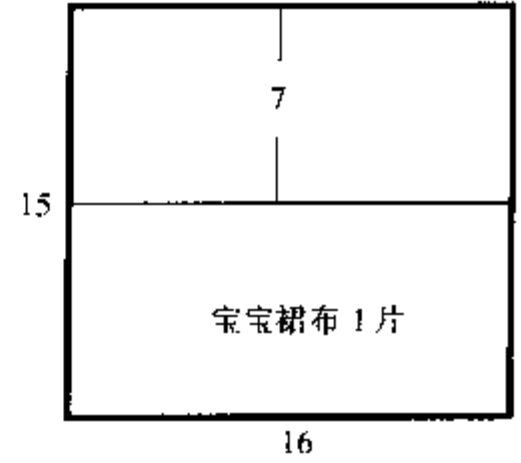

①缝合套身

a. 缝套口抽绳带边

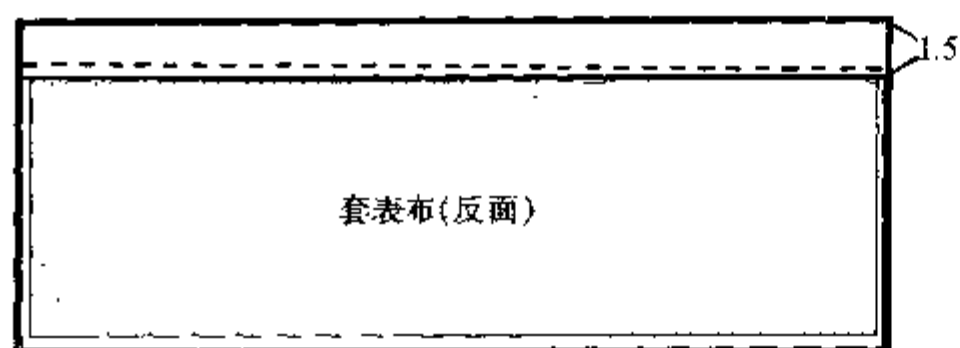

b. 缝合套里布

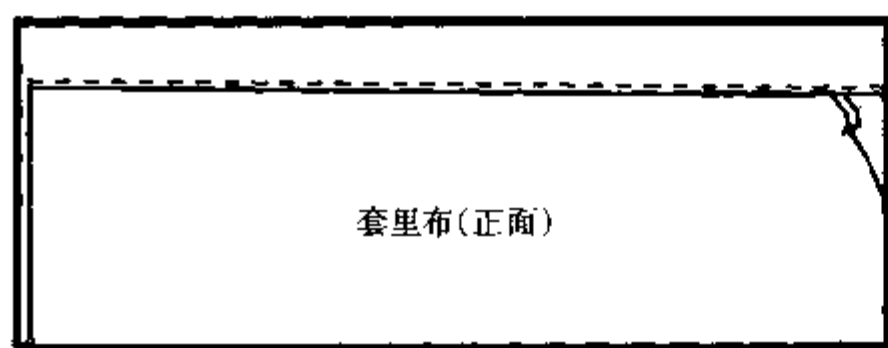

c. 缝合

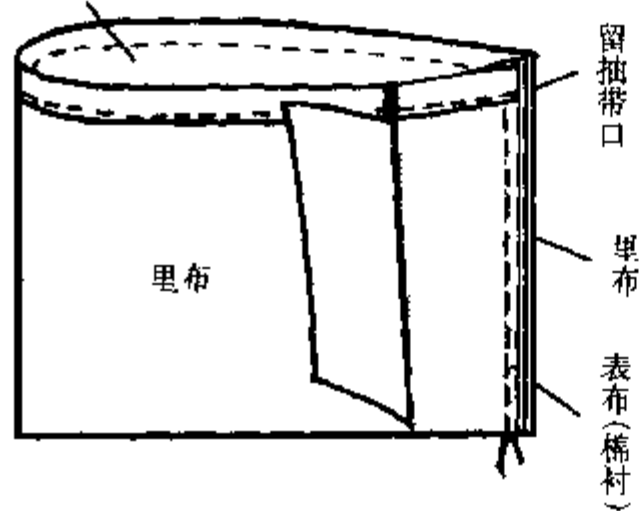

②缝合里布

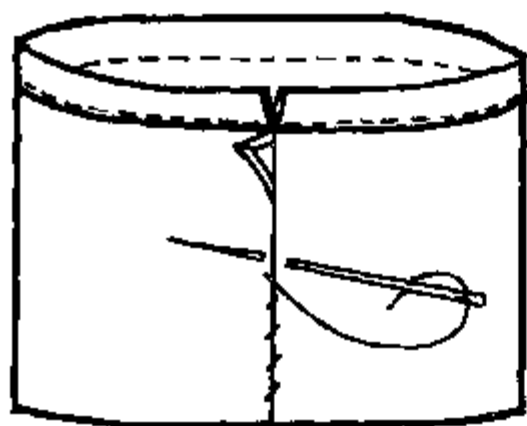

③缝制套底

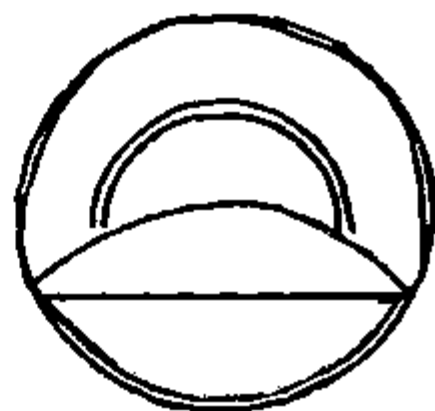

④滚边

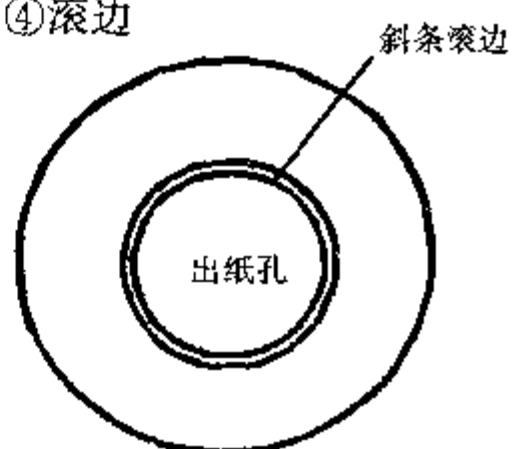

⑤缝合套底

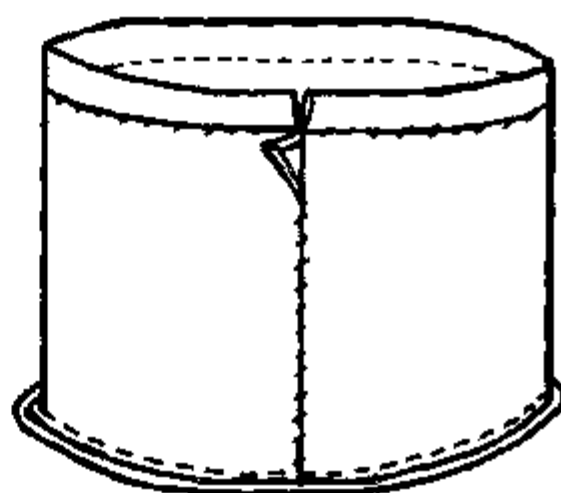

⑥套盖边滚边

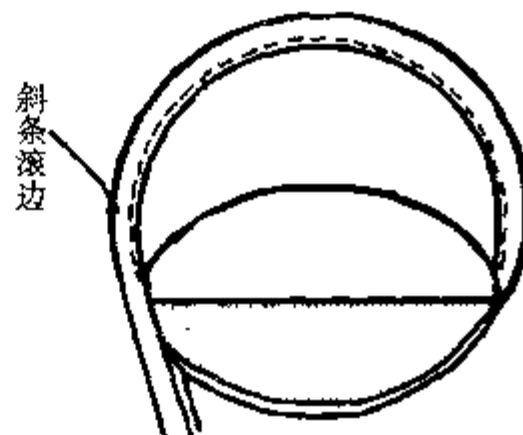

⑦缝合圆盖

圆盖与袋边缝合 1.5

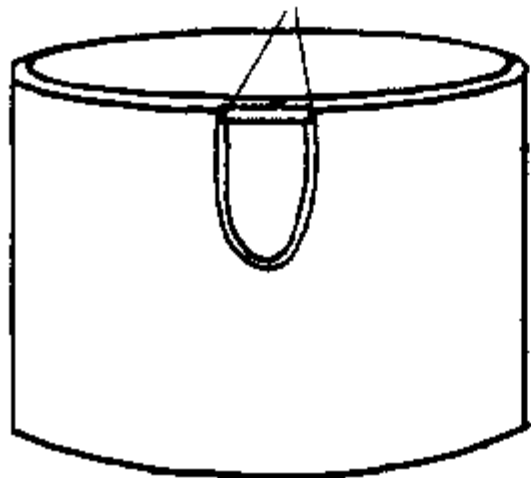

⑨缝小手 2 个、脚 2 个

方法同头部



⑧缝制宝宝头

a. 抽边

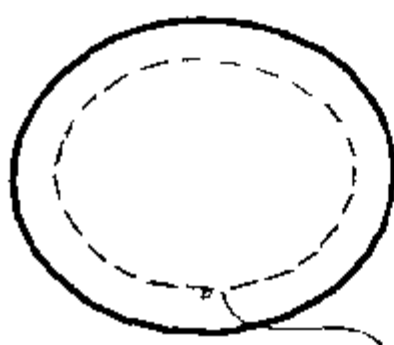

b. 填充膨松棉

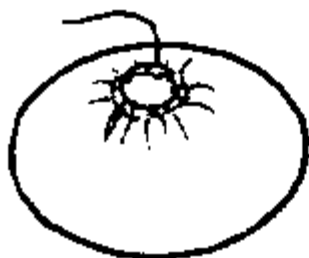

c. 缝黑眼珠



d. 制作头发



黑或金黄色毛线
粘贴在头部

⑩抽缝小帽子

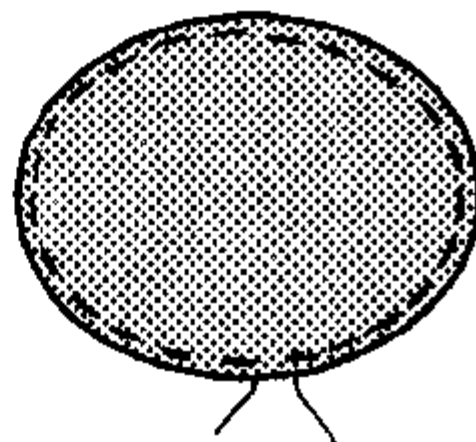

⑪抽缝小裙子

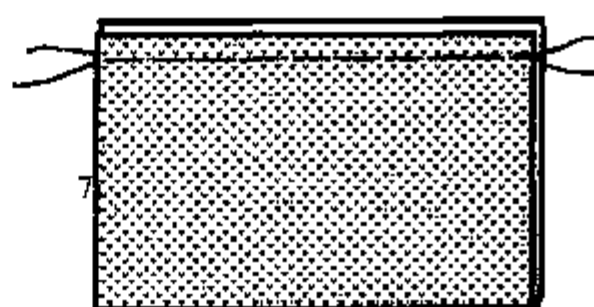

⑫组合宝宝装饰并
缝在圆盖上



(2) 小猫咪贴缝装饰

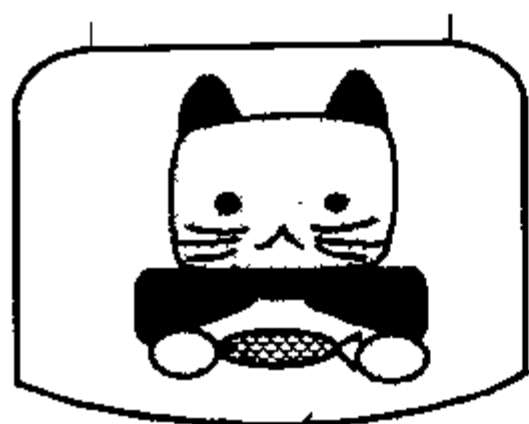

浅蓝、粉、灰、格布

将花布按图示红合并锁边
(内填膨松棉片)

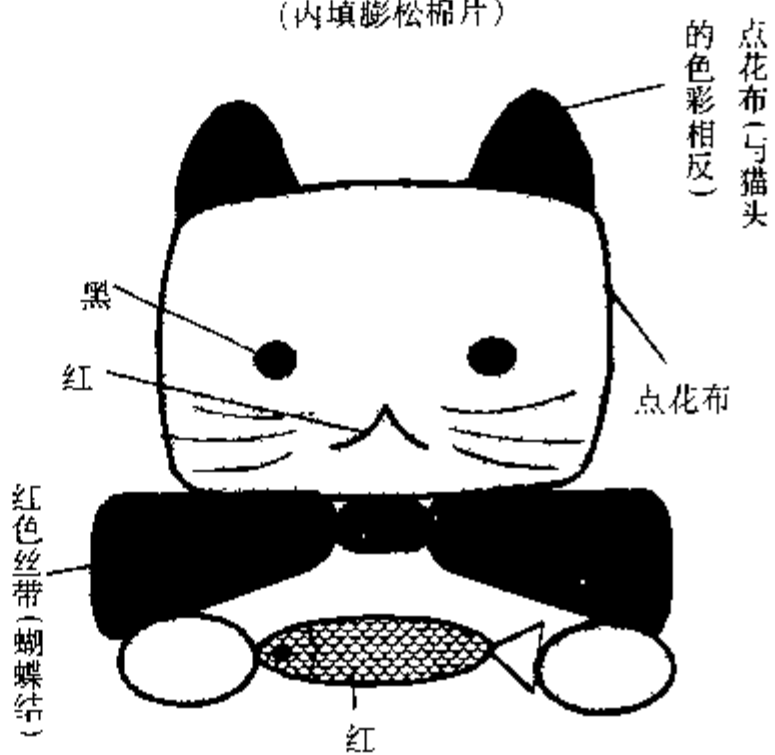

红色丝带(蝴蝶结)

猫头布 1 片



猫耳布 2 片

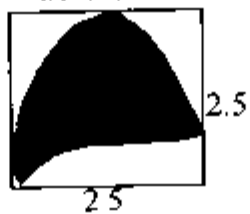

猫爪布 2 片

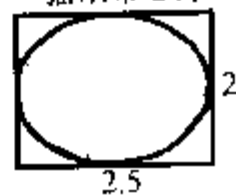

小鱼布 1 片

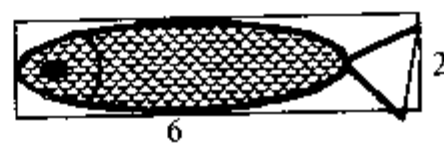



●帽形卫生纸装饰套

盖表布 2 片

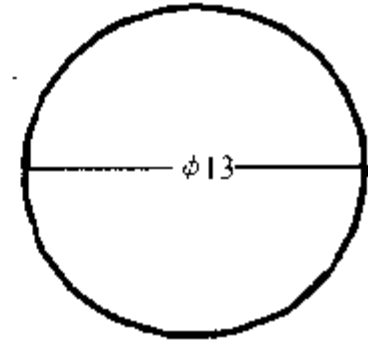

41

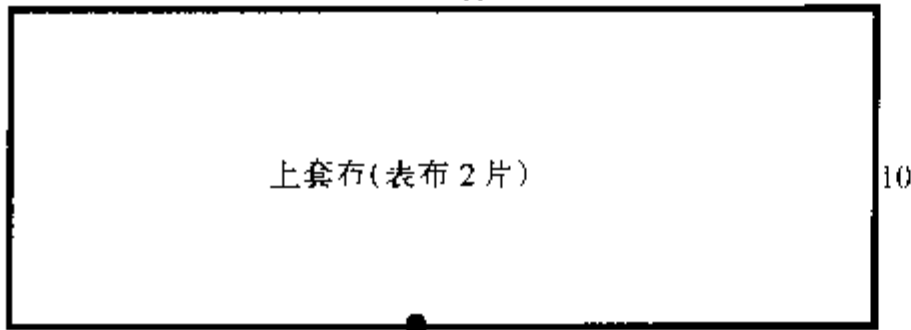

上套布(表布 2 片)

10

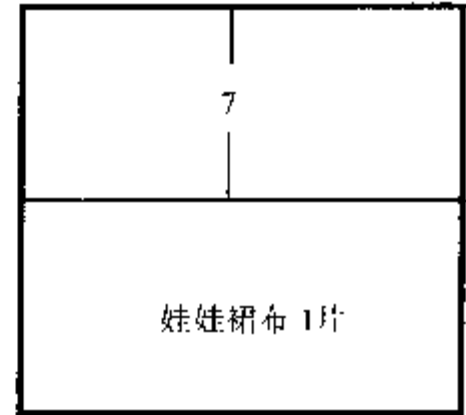

娃娃裙布 1 片

41

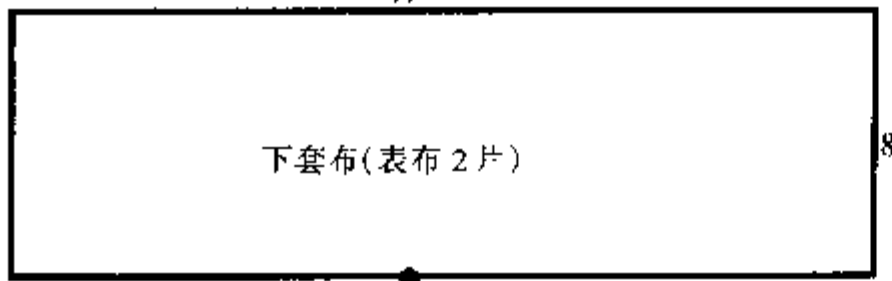

下套布(表布 2 片)

8

娃娃头布 1 片

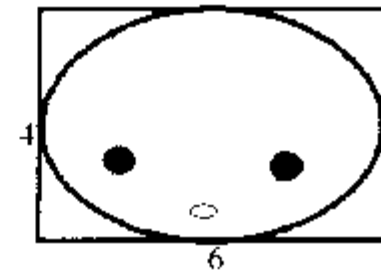

6

套底布 2 片

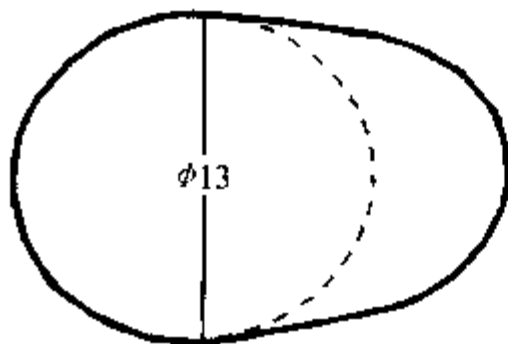

φ13

5

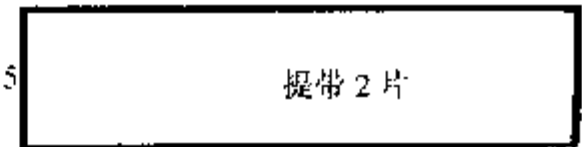

提带 2 片

20

① 缉缝上套布

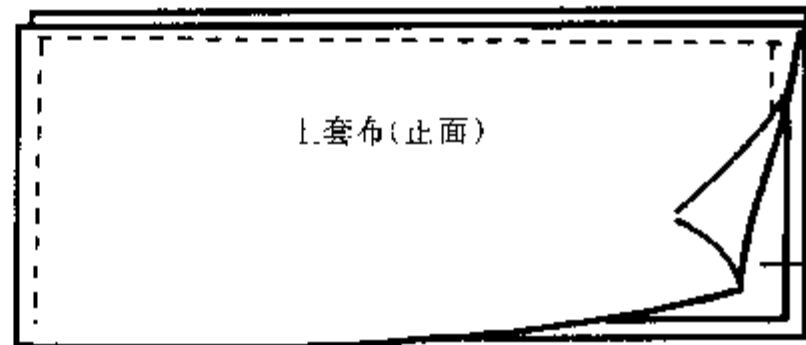

上套布(正面)

棉衬

② 缉缝下套布

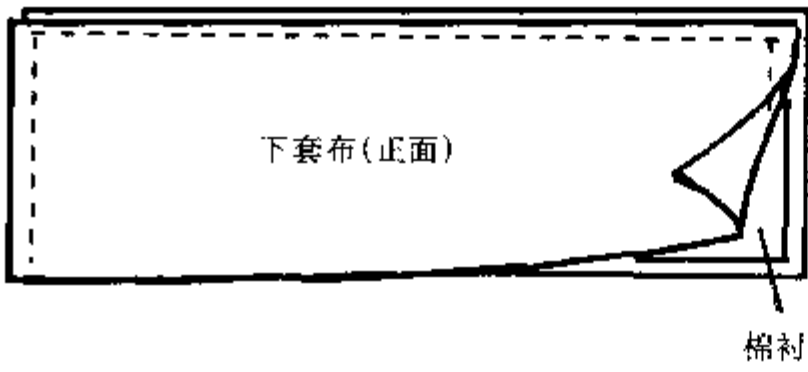

⑥ 缝合侧缝

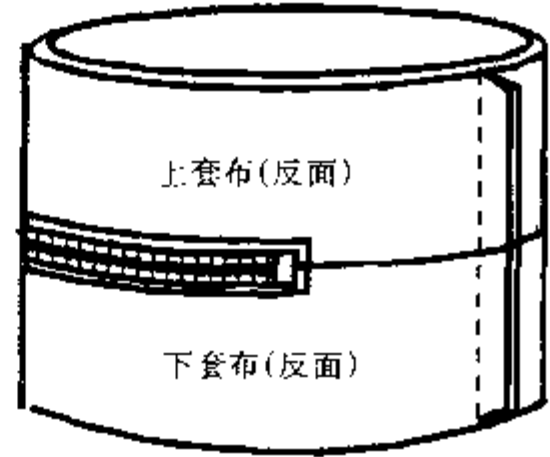

③ 缝合上、下套布, 留出端拉链的开口

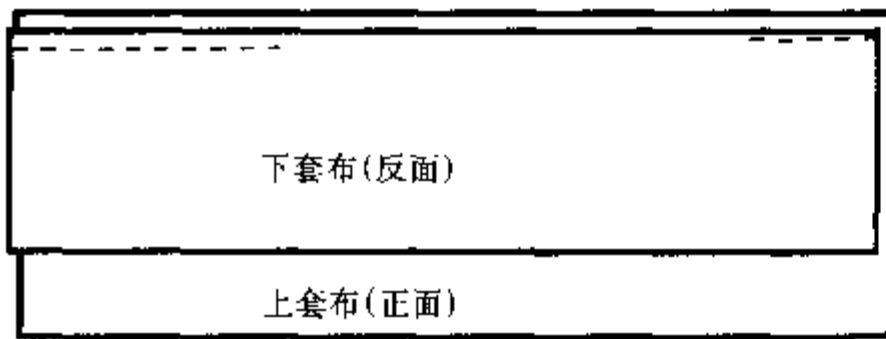

⑦ 提带折边加衬

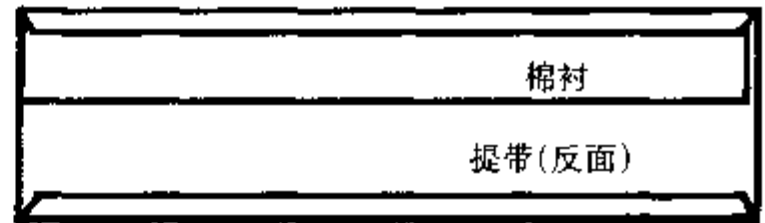

④ 劈缝熨烫

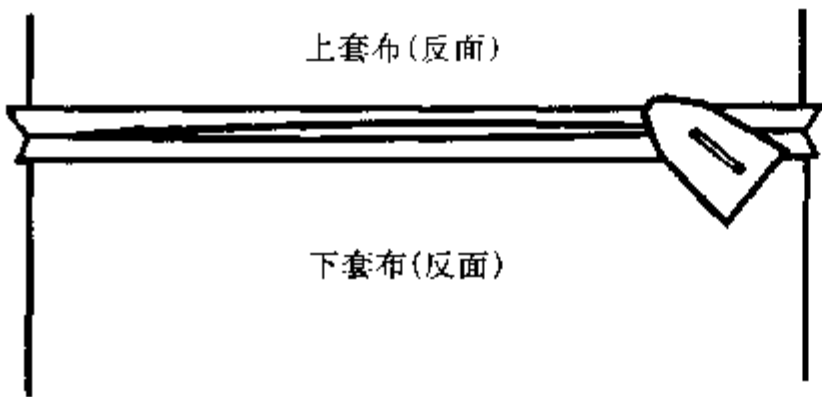

⑧ 缉缝提带

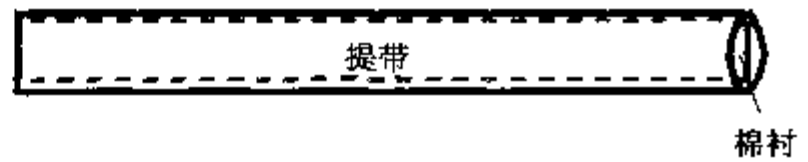

⑤ 缉拉链

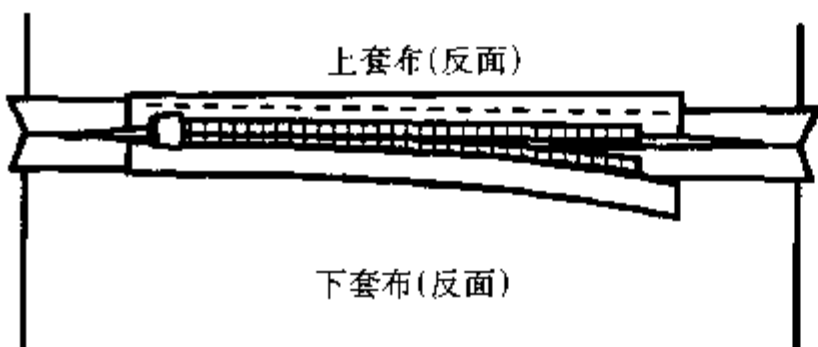

⑨ 缝制圆盖

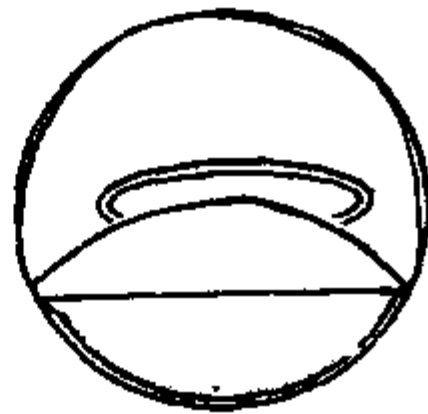

⑩滚边

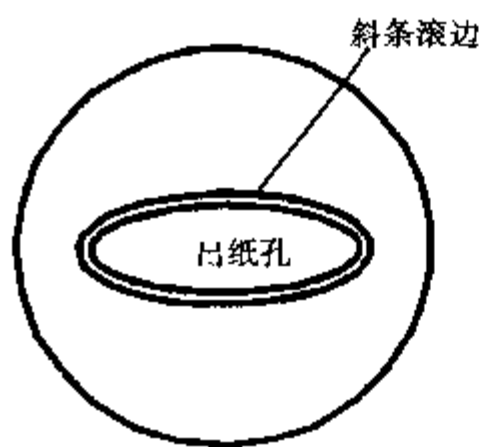

⑪缝合提带

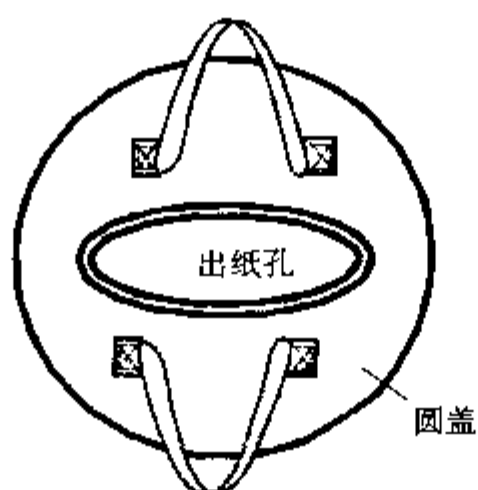

⑫缝合圆盖与套身

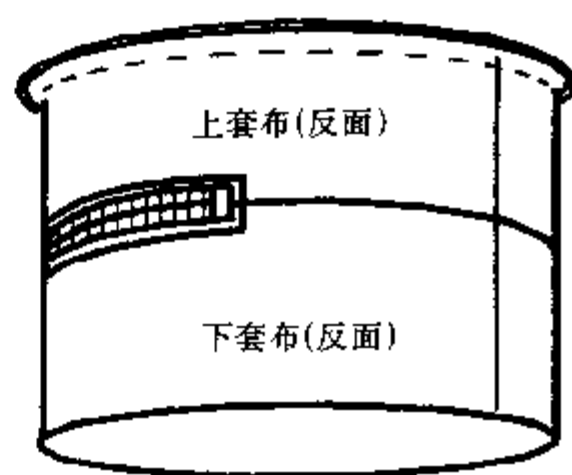

⑬制作套底

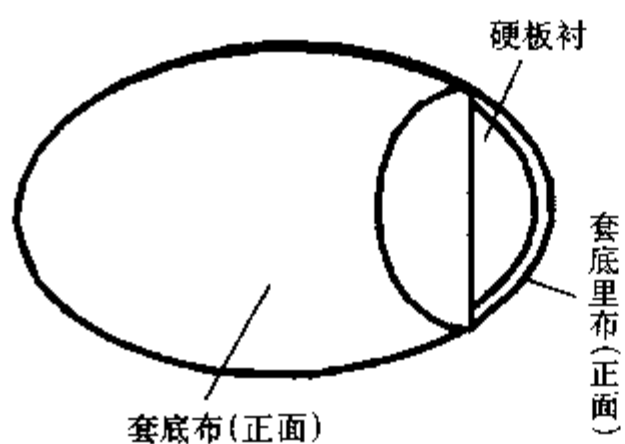

⑭手针线缝套底

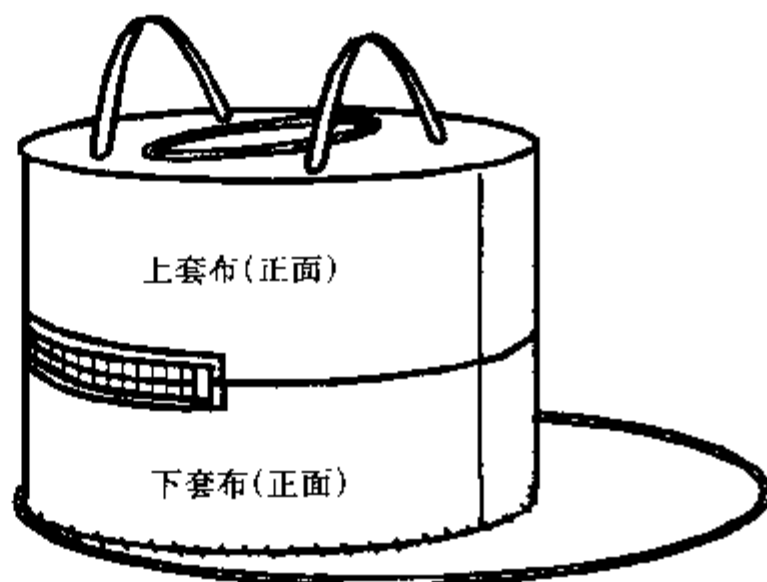

⑮缝制娃娃头部

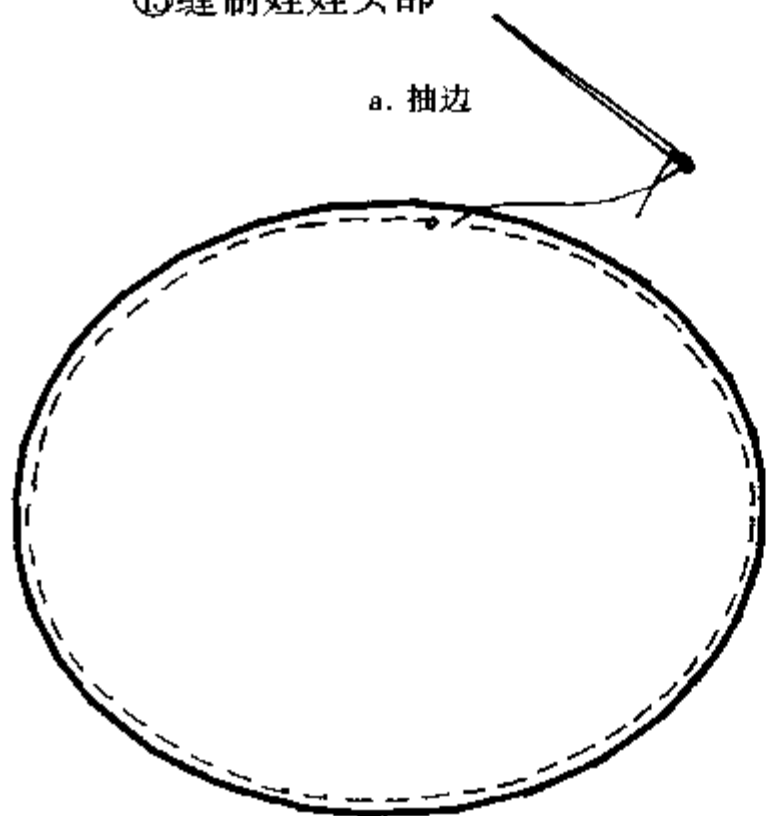

b. 填充膨松棉

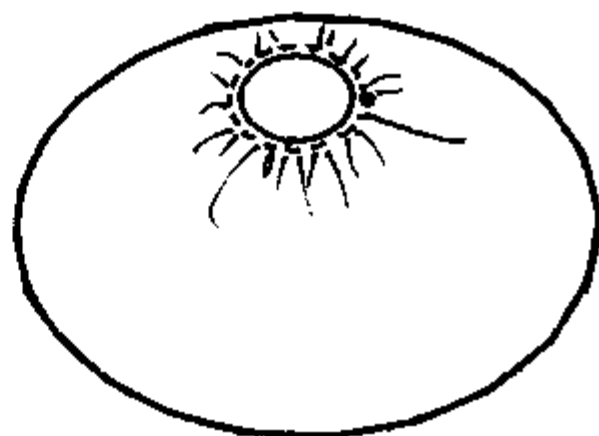

c. 缝眼、嘴及头发

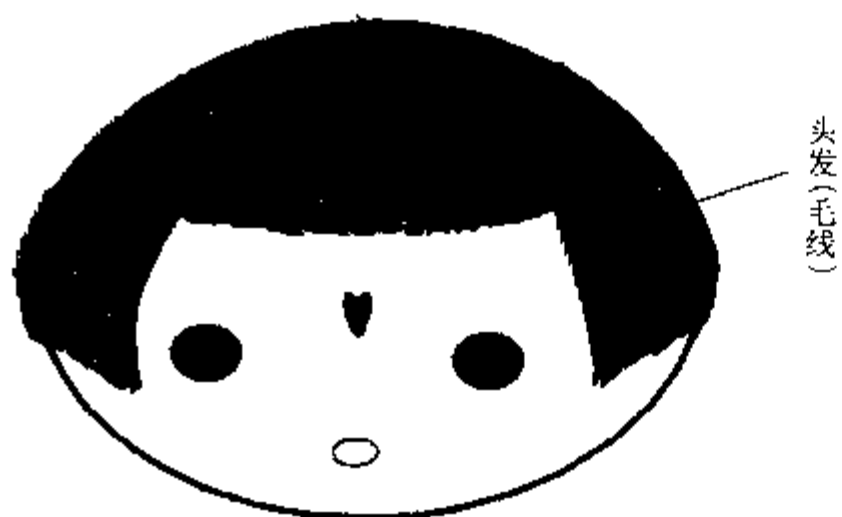

将毛线粘贴在头上，
按图示剪出发型

d. 钉缝装饰蝴蝶结

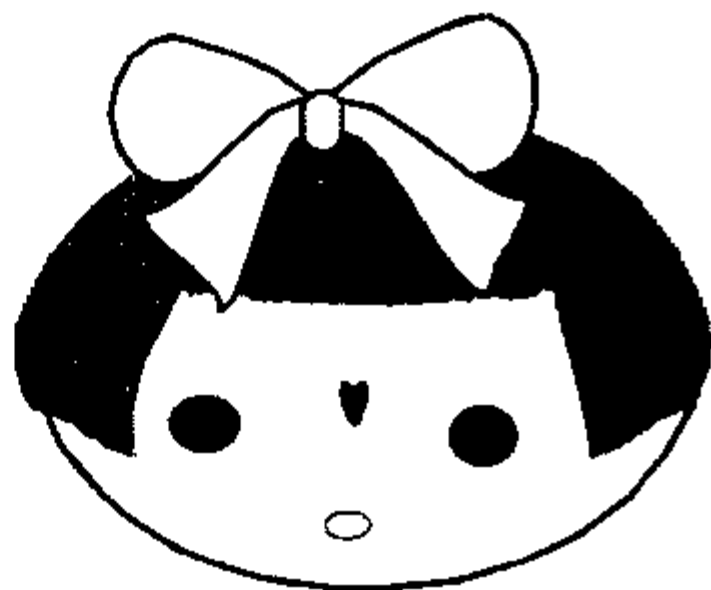

⑩制作小手 2 个

a. 缝合布片



娃娃手(反面)

b. 翻至正面并填充膨松棉



娃娃手(正面)
开口处

⑪抽缝小裙子

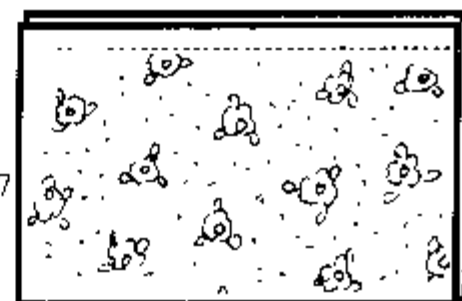

⑫组合装饰娃娃



⑬将装饰娃娃手针线缝于套体上



(1) 小床装饰

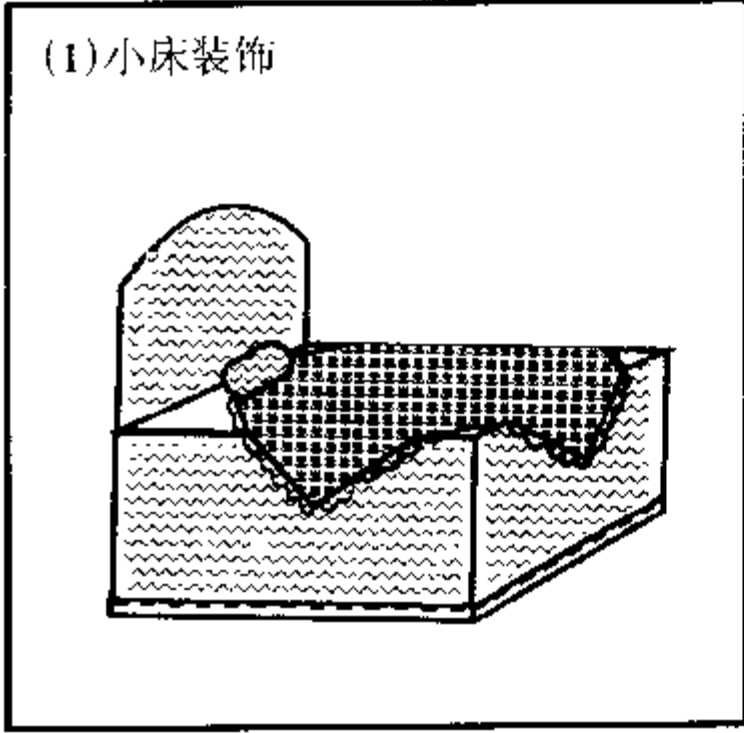

● 餐巾纸装饰套

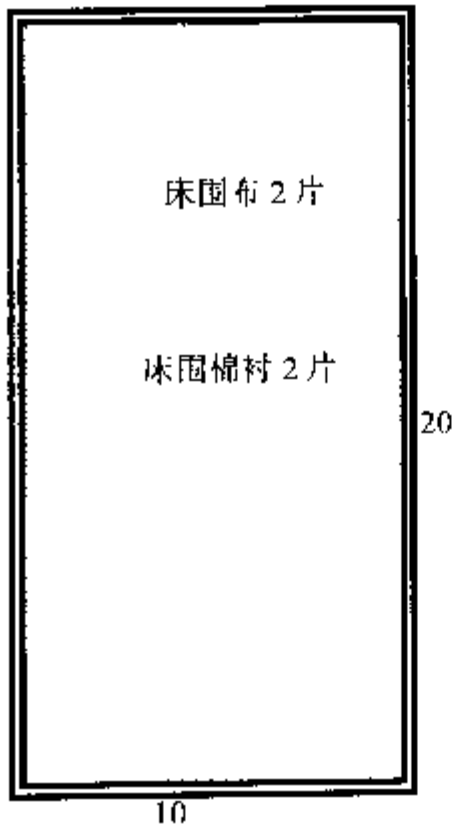
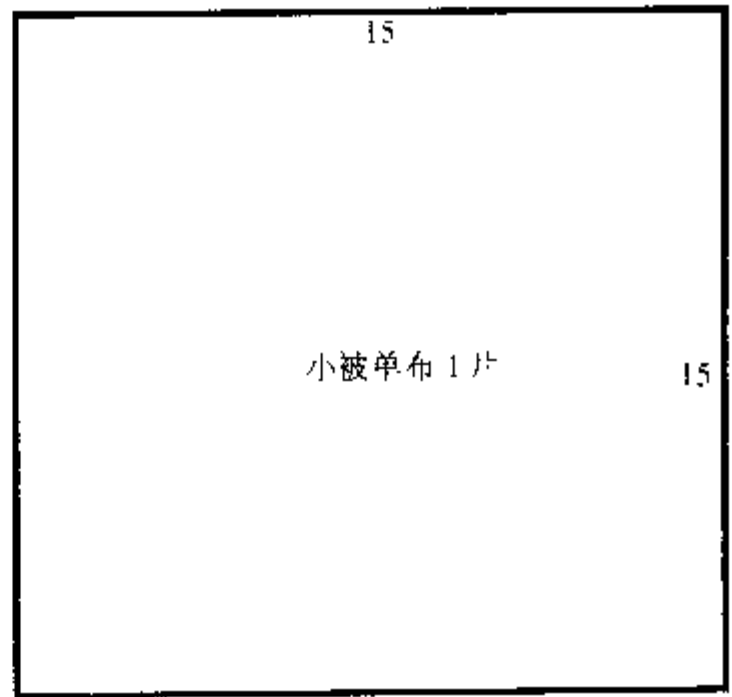
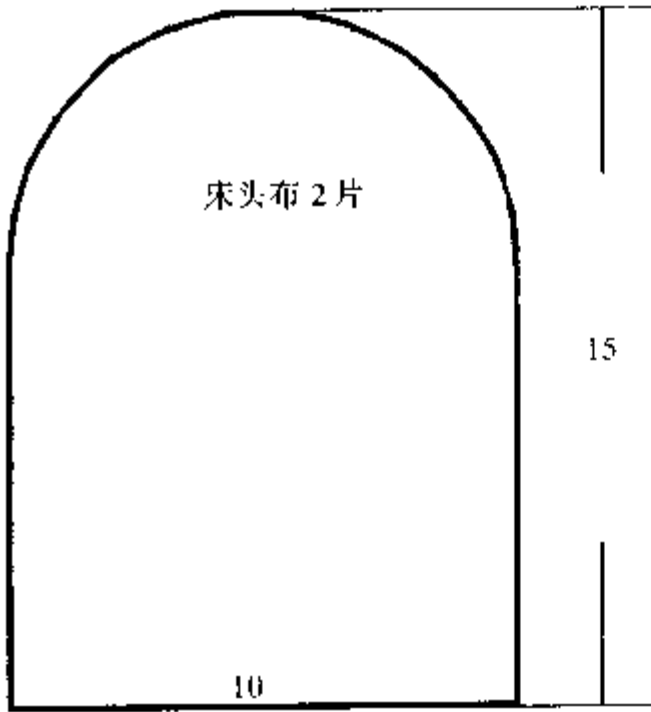
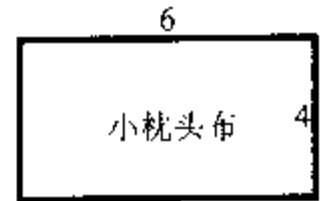

① 缝合床头布

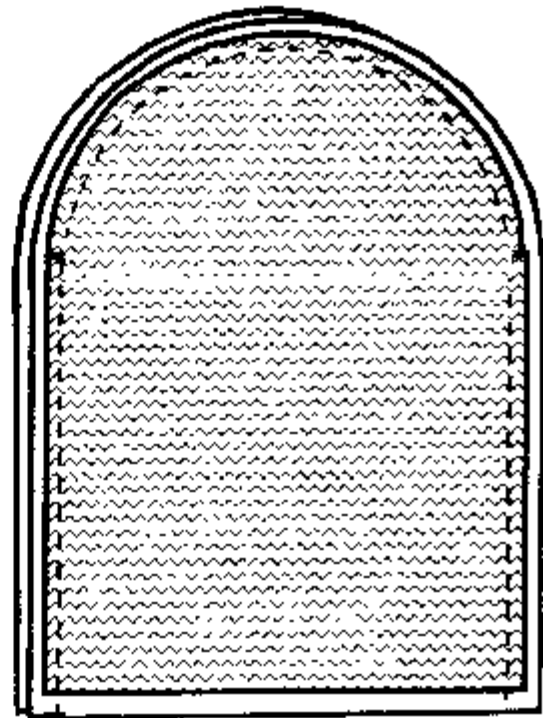

③缝合后床围布与左床围布

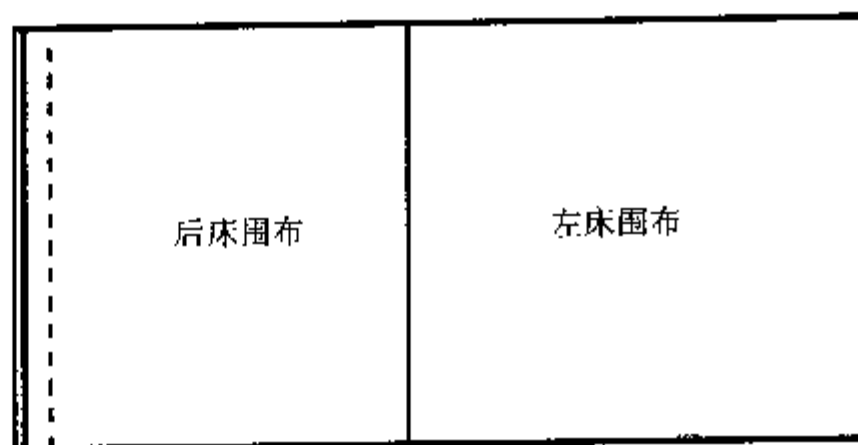

②床头垫硬板衬

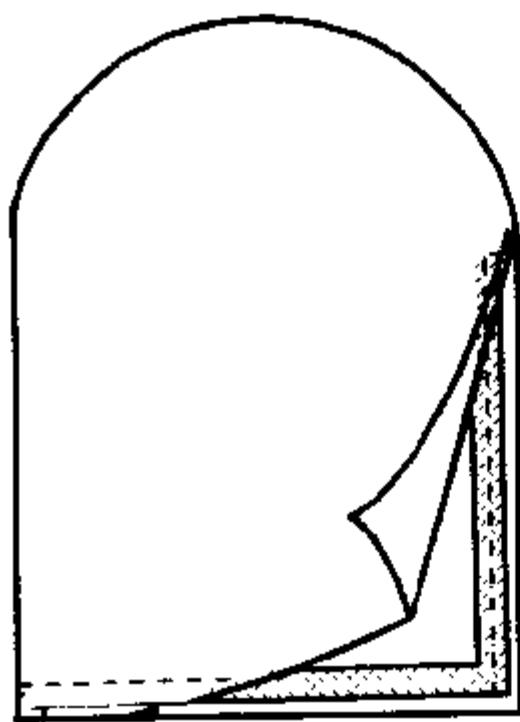

④开口处滚 0.5 的边

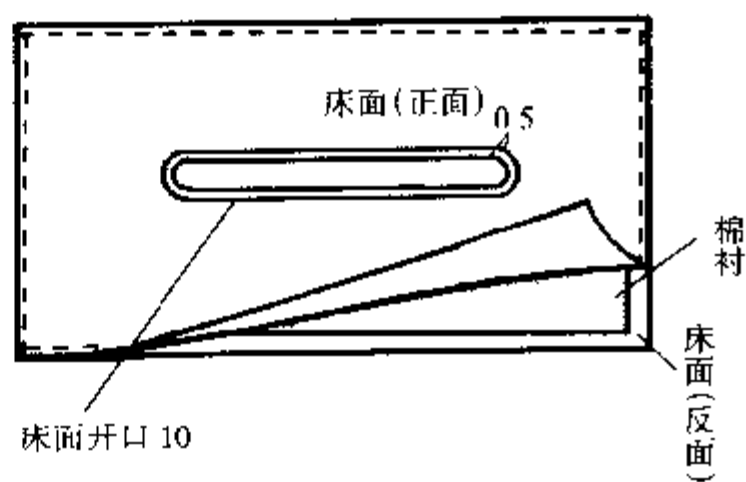

⑤缝合后床围布与右床围布

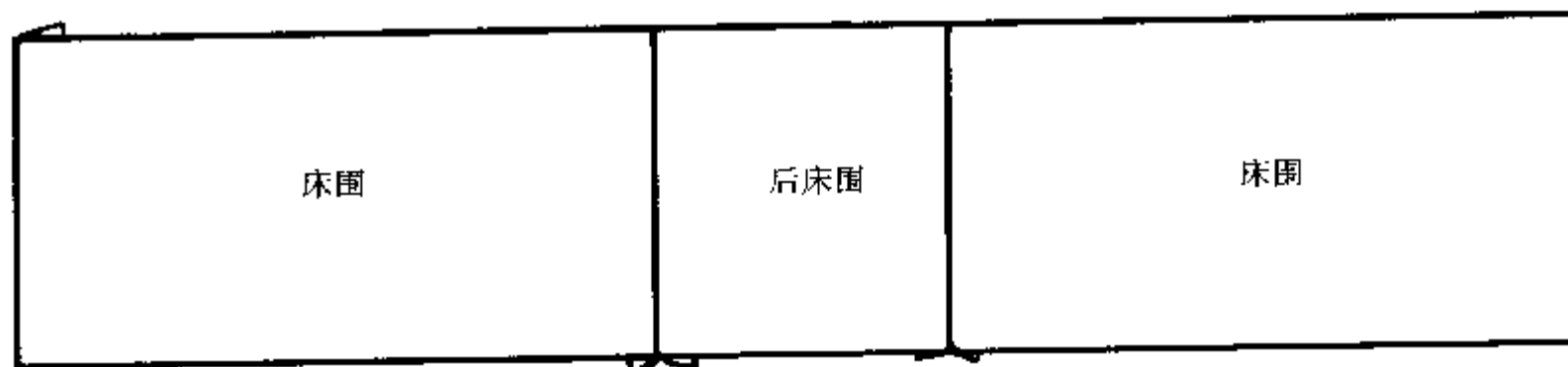
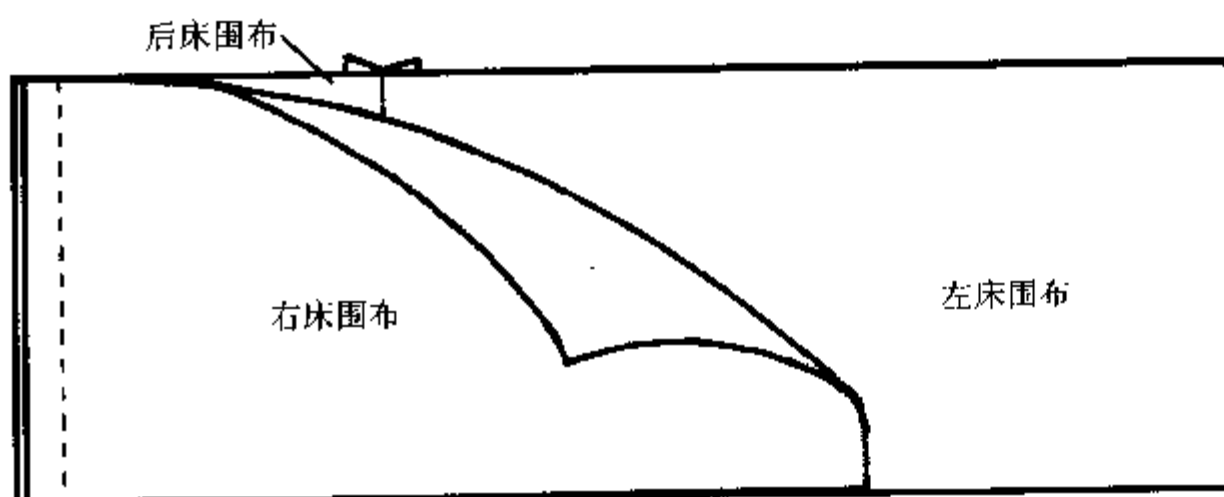

⑥组合床身

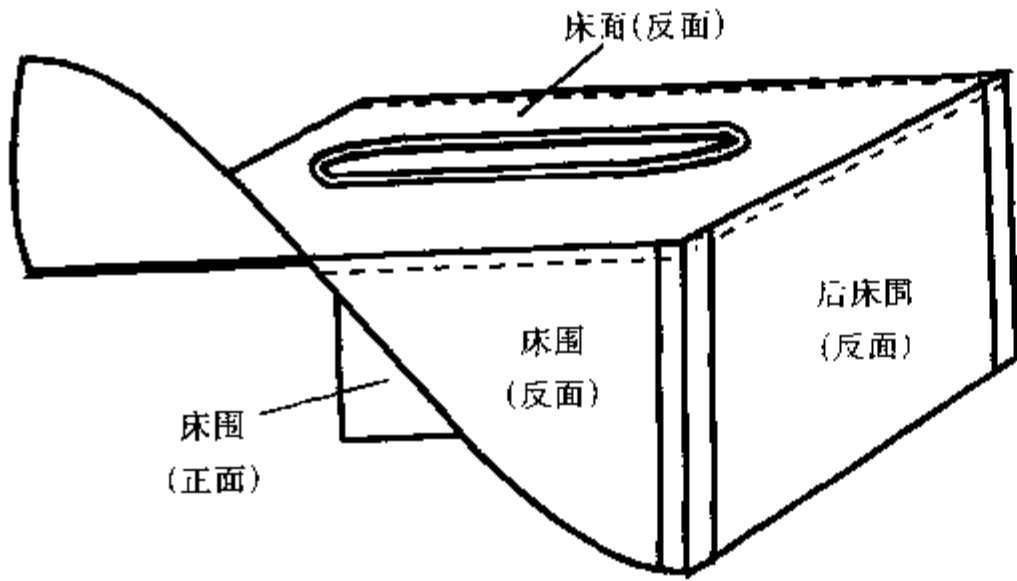

⑨缝制小被单

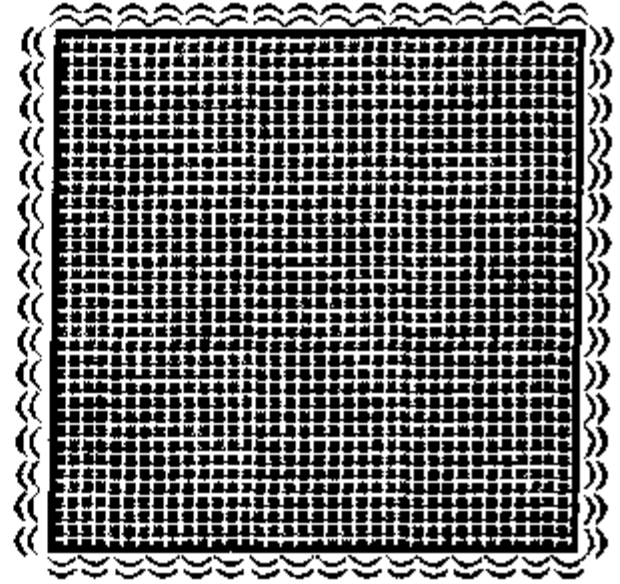

⑦组合床头

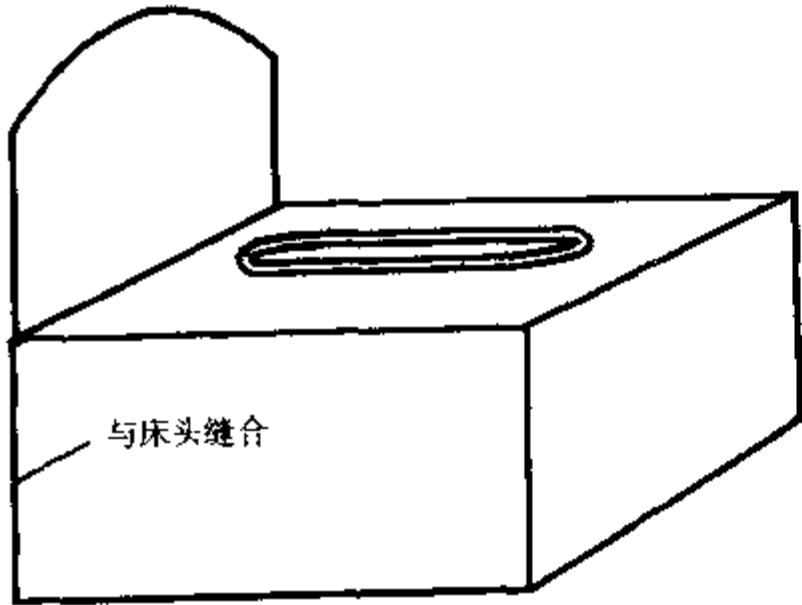

⑩缝制小枕头

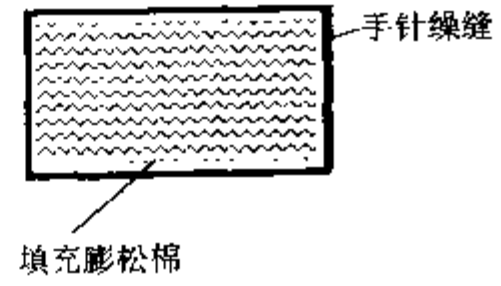

⑧床底部滚边

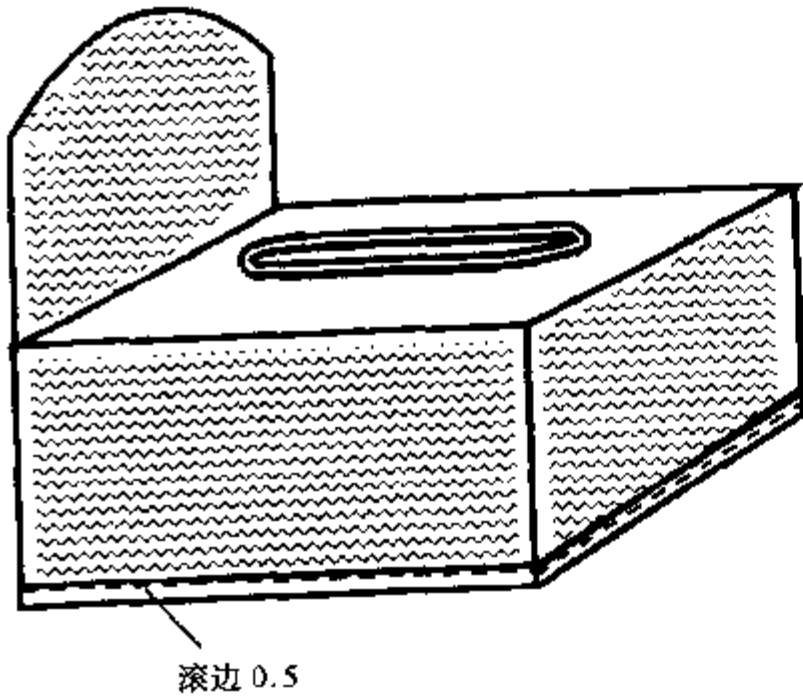

⑪缝合小被单与小枕头

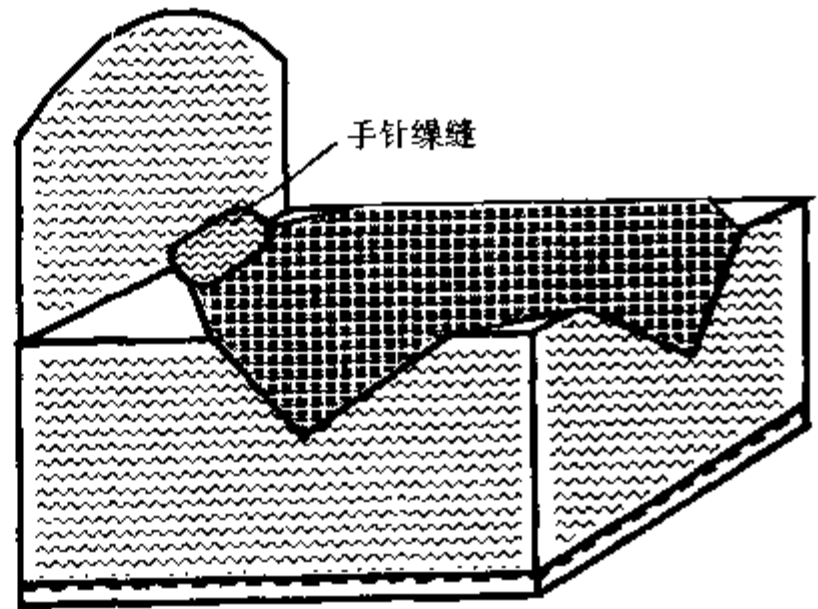

(2) 娃娃装饰

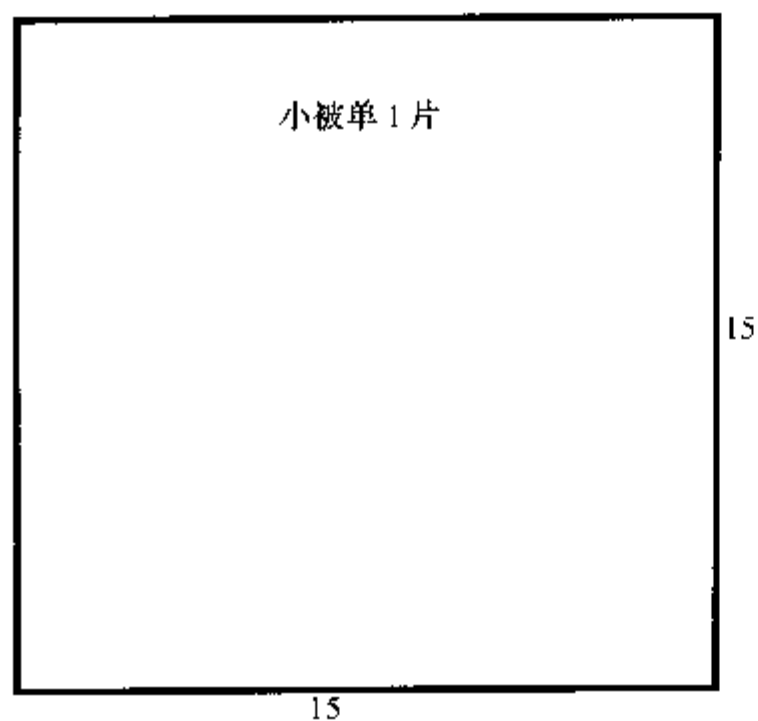
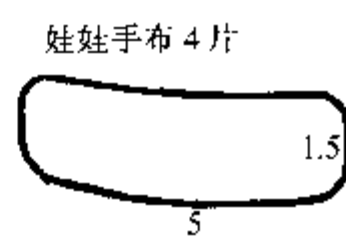
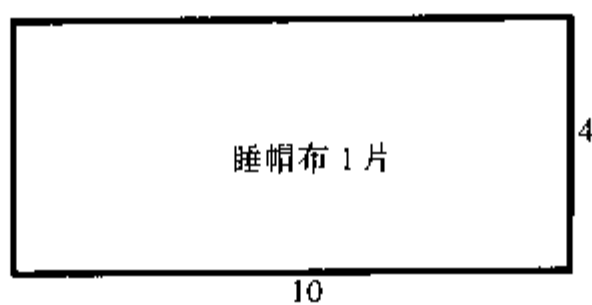
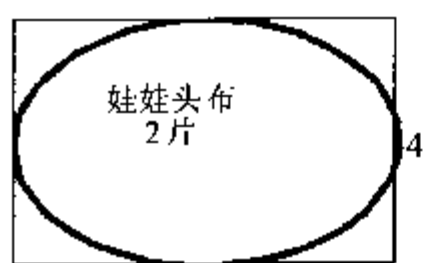

① 制作娃娃头

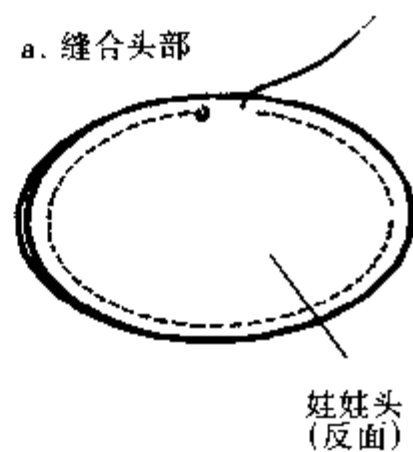

② 缝制睡帽

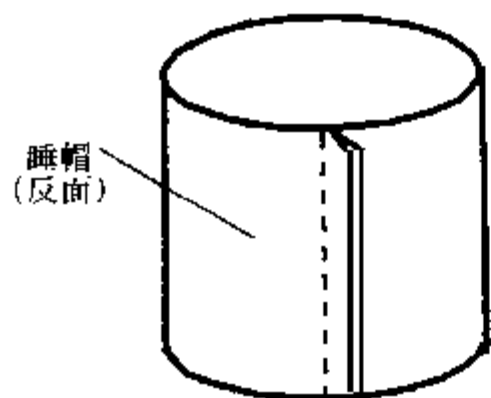

b. 翻至正面并填充膨松棉

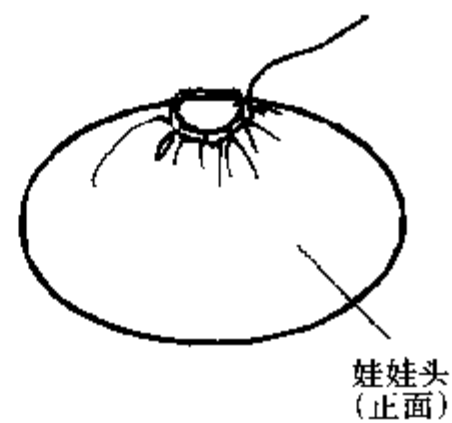

③ 睡帽与娃娃头缝合



c. 缝合眼、鼻及头发



①制作娃娃手

a. 缝合布片

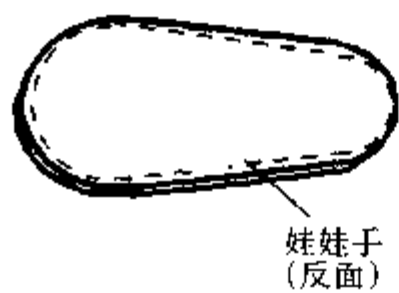

b. 翻至正面并填充膨松棉



⑤缝合娃娃手与娃娃头



⑥在床身上缝合小被单与娃娃

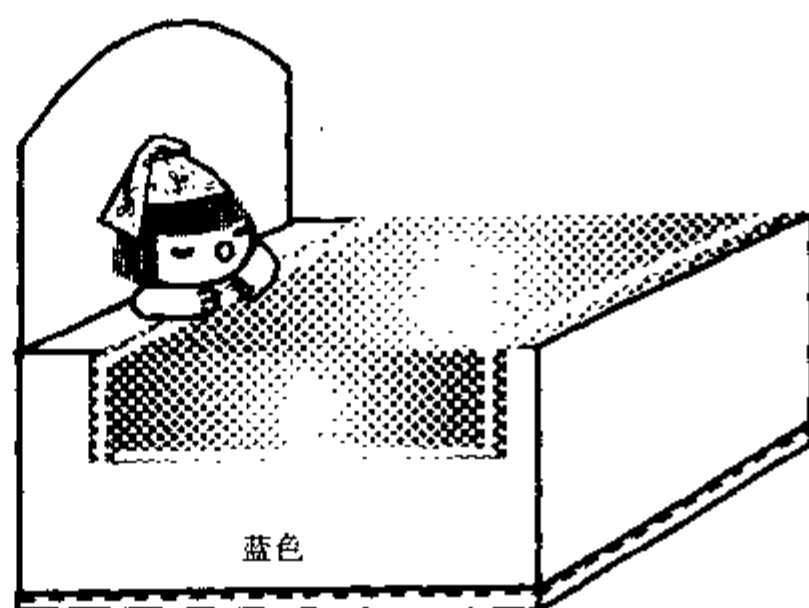

(3) 小狗装饰



制作方法同前

狗尾布 2片

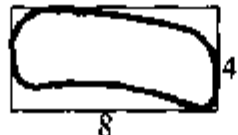

狗鼻布 1片

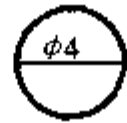

小狗头布 2片

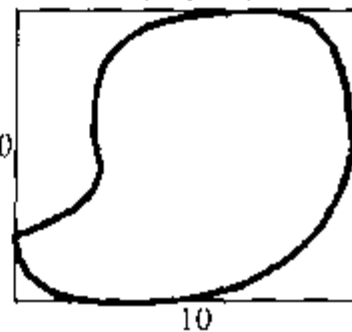

狗舌布 2片

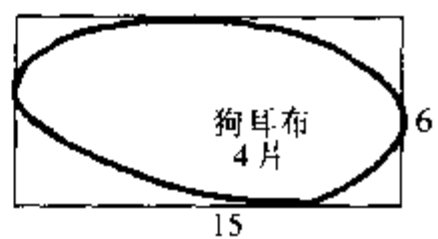
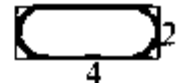

[G e n e r a l I n f o r m a t i o n]

书名 = 休闲配饰小制作

作者 =

页数 = 1 2 9

S S 号 = 0

出版日期 =

V s s 号 = 5 0 2 1 3 2 9 4

封面页
书名页
版权页
前言页
目录页

休闲布帽的制作

圆顶女士帽
圆顶装饰帽
休闲睡帽
少女六片帽
淑女遮阳蝶结帽
八片软檐帽
金秋休闲贝蕾帽
潇洒棒球帽
装饰珠花骑士帽
典雅女士帽
八棱圆形帽
圆顶六片连檐帽
休闲旅游遮阳帽

布包袋的制作

女士挎肩袋
旅行行李袋
少女双肩背袋
休闲购物提袋
折叠方便袋
抽口双肩背袋
淑女挎肩袋
郊游双肩背袋
子母挂包
双肩背子母袋
抽口少女双肩背袋
旅游抽口双肩背圆筒袋
蝶结装饰购物提包
休闲购物套包
折口双肩背袋
圆筒抽口手袋
珠穗抽口手表袋

多用装饰挂袋的制作

补花双兜挂袋
多用鱼纹挂袋
房形装饰挂袋
一帆风顺挂袋
彩格四兜挂袋
多用图案挂袋
联组多用挂袋

实用工艺物品的制作

鱼形抱枕
卫生纸装饰套
帽形卫生纸装饰套
餐巾纸装饰套

附录页